

LabVIEW Graphical Programming Course

Collection edited by:

National Instruments

LabVIEW Graphical Programming Course

Collection edited by:

National Instruments

By:

National Instruments

Malan Shiralkar

(Authors listed in the order their modules appear)

Online:

<<http://cnx.org/content/col10241/1.4/>>

C O N N E X I O N S

Rice University, Houston, Texas

©2007 National Instruments

This selection and arrangement of content is licensed under the Creative Commons Attribution License:
<http://creativecommons.org/licenses/by/1.0>

Table of Contents

1	Student Guide	
1.1	LabVIEW Course Exercise Code	1
2	Introduction	
2.1	LabVIEW	5
2.2	LabVIEW Environment	5
2.3	Front Panel	19
2.4	Block Diagram	22
2.5	Acquiring a Signal VI	27
2.6	Dataflow Programming	37
2.7	Express Filter VI	38
2.8	LabVIEW Documentation Resources	39
2.9	Reduce Samples VI	42
2.10	Debugging Techniques	48
2.11	Debug Exercise (Main) VI	49
2.12	Summary, Tips, and Tricks on Introduction to LabVIEW	52
3	Modular Programming	
3.1	Modular Programming	57
3.2	Icons and Connector Panes	59
3.3	Convert C to F VI	63
3.4	Using SubVIs	66
3.5	Thermometer VI	67
3.6	Creating a SubVI from Sections of a VI	71
3.7	Summary, Tips, and Tricks on Modular Programming	72
4	Repetition and Loops	
4.1	While Loops	73
4.2	Auto Match VI	75
4.3	For Loops	79
4.4	Timed Temperature VI	81
4.5	Accessing Previous Loop Data	83
4.6	Accessing Previous Data VI	85
4.7	Summary, Tips, and Tricks on Repetition and Loops	88
5	Arrays	
5.1	Arrays	91
5.2	Auto-Indexing	93
5.3	Array Functions	94
5.4	Polymorphism	96
5.5	Array Exercise VI	97
5.6	Summary, Tips, and Tricks on Arrays	98
5.7	Additional Exercises for Arrays	99
6	Clusters	
6.1	Clusters	101
6.2	Cluster Functions	103
6.3	Cluster Exercise VI	105
6.4	Cluster Scaling VI	108
6.5	Error Clusters	109

6.6	Summary, Tips, and Tricks on Clusters	111
7	Plotting Data	
7.1	Waveform Charts	113
7.2	Temperature Monitor VI	115
7.3	Temperature Running Average VI	121
7.4	Waveform and XY Graphs	125
7.5	Graph Waveform Array VI	127
7.6	Temperature Analysis VI	132
7.7	Graph Circle VI	135
7.8	Intensity Plots	137
7.9	Intensity Graph Example VI	138
7.10	Summary, Tips, and Tricks on Plotting Data	139
7.11	Additional Exercises for Plotting Data	140
8	Making Decisions in a VI	
8.1	Making Decisions with the Select Function	143
8.2	Case Structures	144
8.3	Square Root VI	148
8.4	Temperature Control VI	150
8.5	Formula Node	153
8.6	Formula Node Exercise VI	154
8.7	Summary, Tips, and Tricks on Making Decisions in a VI	155
8.8	Additional Exercises for Making Decisions in a VI	156
9	Strings and File I/O	
9.1	Strings	157
9.2	String Functions	159
9.3	Create String VI	162
9.4	File I/O VIs and Functions	165
9.5	High-Level File I/O VIs	167
9.6	Spreadsheet Example VI	168
9.7	Low-Level File I/O VI and Functions	171
9.8	File Writer VI	173
9.9	File Reader VI	175
9.10	Formatting Spreadsheet Strings	177
9.11	Temperature Logger VI	180
9.12	Temperature Application VI	184
9.13	Summary, Tips, and Tricks on Strings and File I/O	185
9.14	Additional Exercises for Strings and FileI/O	186
10	Data Acquisition and Waveforms	
10.1	Overview and Configuration of DAQ Devices	187
10.2	Measurement & Automation Explorer (Windows Only)	191
10.3	Data Acquisition in LabVIEW	194
10.4	Analog Input	195
10.5	Voltmeter VI	197
10.6	Measurement Averaging VI	199
10.7	Data Logging	200
10.8	Simple Data Logger VI	201
10.9	Analog Output	204
10.10	Voltage Output VI	205
10.11	Counters	208

10.12	Simple Event Counting VI	209
10.13	Digital I/O	210
10.14	Digital Example VI	210
10.15	Summary, Tips, and Tricks on Data Acquisition and Waveforms	211
10.16	Additional Exercises for Data Acquisition and Waveforms	212
11	Instrument Control	
11.1	Instrument Control Overview	213
11.2	GPIB Communication and Configuration	213
11.3	GPIB Configuration with MAX (Windows Only)	216
11.4	Using the Instrument I/O Assistant	218
11.5	Using the Instrument I/O Assistant Exercise	219
11.6	VISA	220
11.7	Programming with VISA	222
11.8	About Instrument Drivers	224
11.9	Using Instrument Driver VIs	224
11.10	Voltage Monitor VI	227
11.11	Serial Port Communication	229
11.12	Serial Write & Read VI	234
11.13	Waveform Transfers	237
11.14	Waveform Example VI	240
11.15	Summary, Tips, and Tricks on Instrument Control	243
11.16	Additional Exercises for Instrument Control	243
12	Customizing VIs	
12.1	Configuring the Appearance of Front Panels	245
12.2	Opening SubVI Front Panels when a VI Runs	247
12.3	Pop-up Graph VI and Use Pop-up Graph VI	247
12.4	Keyboard Shortcuts for Controls	250
12.5	Temperature System VI	250
12.6	Editing VI Properties	252
12.7	Edit Me VI	253
12.8	Customizing the Controls and Functions Palettes	254
12.9	Summary, Tips, and Tricks on Customizing VIs	254
13	Appendix	
13.1	Appendix	257
	Attributions	265

Chapter 1

Student Guide

1.1 LabVIEW Course Exercise Code

1.1.1 A. About This Course

This course teaches you how to use LabVIEW to develop test and measurement, data acquisition, instrument control, datalogging, measurement analysis, and report generation applications. This course assumes that you are familiar with Windows, Mac OS, or UNIX and that you have experience writing algorithms in the form of flowcharts or block diagrams.

The course is divided into lessons, each covering a topic or a set of topics. Each lesson consists of the following:

- An introduction that describes the purpose of the lesson and what you will learn
- A description of the topics in the lesson
- A set of exercises to reinforce those topics. Some lessons include optional and challenge exercise sections or a set of additional exercises to complete if time permits.
- A summary that outlines important concepts and skills taught in the lesson

Several exercises in this manual use one of the following National Instruments hardware products:

- A plug-in multifunction data acquisition (DAQ) device connected to a DAQ Signal Accessory containing a temperature sensor, function generator, and LEDs
- A GPIB interface connected to an NI Instrument Simulator



If you do not have this hardware, you still can complete most of the exercises. Be sure to use the demo versions of the VIs when you are working through exercises. Exercises that explicitly require hardware are indicated with an icon, shown in Figure 1. You also can substitute other hardware for those previously mentioned. For example, you can use a GPIB instrument in place of the NI Instrument Simulator, or another National Instruments DAQ device connected to a signal source, such as a function generator.

1.1.2 B. What You Need to Get Started

Before you use this course manual, ensure you have all the following items:

- (Windows) Windows 98 or later installed on your computer; (Mac OS) System 10.2 or later for Mac OS X, System 9.1 or later for OS 9.x or earlier; (UNIX) Sun workstation running Solaris 2.5.1 or later and X Window System server, such as OpenWindows, CDE, or X11R6, or a PC running Linux kernel 2.0.x or later for Intel x86 processors
- (Windows) Multifunction DAQ device configured as device 1 using Measurement & Automation Explorer (MAX)
- DAQ Signal Accessory, wires, and cable
- GPIB interface
- NI Instrument Simulator and power supply
- LabVIEW Full or Professional Development System 7.0 or later.

This course assumes you are using the default installation of LabVIEW. If you have changed the palette views from the default settings, some palette paths described in the course may not match your settings. To reset palette views to LabVIEW defaults, select Tools»Options and select Controls/Functions Palettes from the top pull-down menu. Set Palette View to Express and set Format to Standard. Click the OK button to apply the changes and close the dialog box.

- A serial cable
- A GPIB cable
- (Optional) A word processing application such as Notepad or WordPad
- The following files provided

Filename	Description
Exercises ¹	Folder for saving VIs created during the course and for completing certain course exercises; also includes subVIs necessary for some exercises
nidevsim.zip	Zip file containing the LabVIEW instrument driver for the NI Instrument Simulator (Contained in Exercises.zip)
Solutions ²	Folder containing the solutions to all the course exercises

1.1.3 C. Installing the Course Software

Complete the following steps to install the course software.

1. Copy the contents of the nidevsim directory to the labview\instr.lib directory. After you start LabVIEW, the NI DevSim instrument driver is located on the Functions»Input»Instrument Drivers palette.
2. Copy the Exercises directory³ to the top level of the C: directory.
3. Copy the Solutions directory⁴ to the top level of the C: directory.

³<http://cnx.org/content/m14634/latest/Exercises.zip>

⁴<http://cnx.org/content/m14634/latest/Solutions.zip>

1.1.4 D. Course Goals and Non-Goals

This course prepares you to do the following:

- Understand front panels, block diagrams, icons, and connector panes
- Use the programming structures and data types that exist in LabVIEW
- Use various editing and debugging techniques
- Create and save VIs so you can use them as subVIs
- Display and log data
- Create applications that use plug-in DAQ devices
- Create applications that use serial port and GPIB instruments

This course does not describe any of the following:

- Every built-in VI, function, or object; refer to the LabVIEW Help for more information about LabVIEW features not described in this course
- Analog-to-digital (A/D) theory
- Operation of the serial port
- Operation of the GPIB bus
- Developing an instrument driver
- Developing a complete application for any student in the class; refer to the NI Example Finder, available by selecting Help»Find Examples, for example VIs you can use and incorporate into VIs you create

NOTE: If you need assistance beyond that provided in this course, you can post a message to the National Instruments discussion forums at: <http://forums.ni.com/>

Chapter 2

Introduction

2.1 LabVIEW

LabVIEW programs are called **virtual instruments**, or **VIs**, because their appearance and operation imitate physical instruments, such as oscilloscopes and multimeters. LabVIEW contains a comprehensive set of tools for acquiring analyzing, displaying, and storing data, as well as tools to help you troubleshoot your code.

LabVIEW VIs contain three components—the **front panel**, the **block diagram**, and the **icon and connector pane**. This lesson describes the front panel and the block diagram; refer to Modular Programming (Section 3.1) for more information about the icon and the connector pane.

In LabVIEW, you build a user interface, or front panel, with controls and indicators. Controls are knobs, push buttons, dials, and other input devices. Indicators are graphs, LEDs, and other displays. After you build the user interface, you add code using VIs and structures to control the front panel objects. The block diagram contains this code. In some ways, the block diagram resembles a flowchart.

Use LabVIEW to communicate with hardware such as data acquisition, vision, and motion control devices, and GPIB, PXI, VXI, RS-232, and RS-484 devices. LabVIEW also has built-in features for connecting your application to the Web using the LabVIEW Web Server and software standards such as TCP/IP networking and ActiveX.

Using LabVIEW, you can create test and measurement, data acquisitions, instrument control, datalogging, measurement analysis, and report generation applications. You also can create stand-alone executables and shared libraries, like DLLs, because LabVIEW is a true 32-bit compiler.

2.2 LabVIEW Environment

When you launch LabVIEW, the navigation dialog box (Figure 2.1) appears that includes introductory material and common commands.

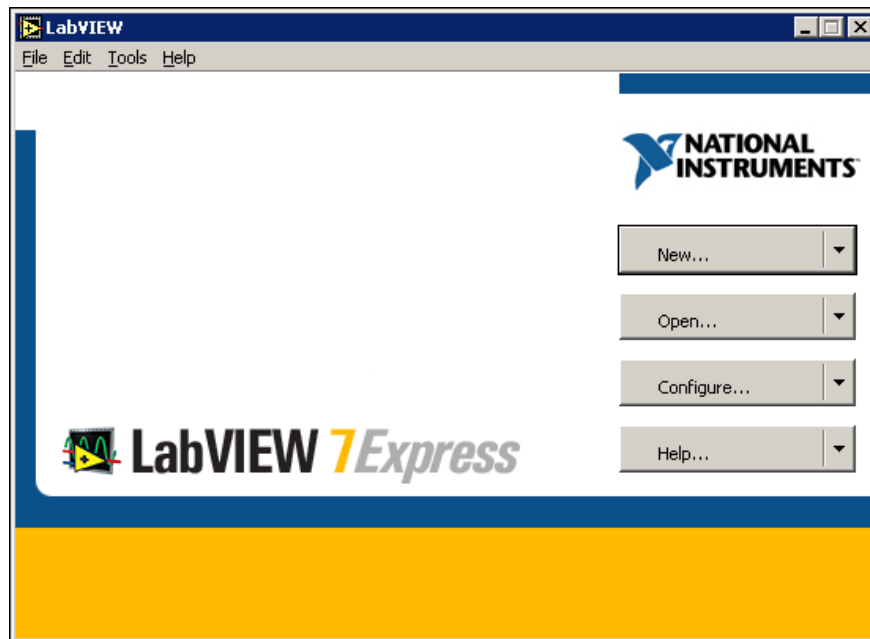

Figure 2.1: LabVIEW Dialog Box

The LabVIEW dialog box includes the following components:

- A menu with standard items such as File»Exit.
- A set of buttons for creating and opening VIs, configuring data acquisition devices, and finding helpful information.
 - Click the New button to create a new VI. Click the arrow on the New button to choose to open a blank VI or to open the New dialog box.
 - Click the Open button to open an existing VI. Click the arrow on the Open button to open recent files.
 - Click the Configure button to configure your data acquisition devices. Click the arrow on the Configure button to configure LabVIEW.
 - Click the Help button to launch the *LabVIEW Help*. Click the arrow on the Help button for other Help options, including the NI Example Finder.

2.2.1 Creating and Saving a VI

When you click the New button in the LabVIEW dialog box, the New dialog box appears. You also can select File»New to display this dialog box. When you select a template in the Create new list, previews of the VI appear in the Front panel preview and the Block diagram preview sections, and a description of the template appears in the Description section. Figure 2.2 shows the New dialog box and the SubVI with Error Handling VI template.

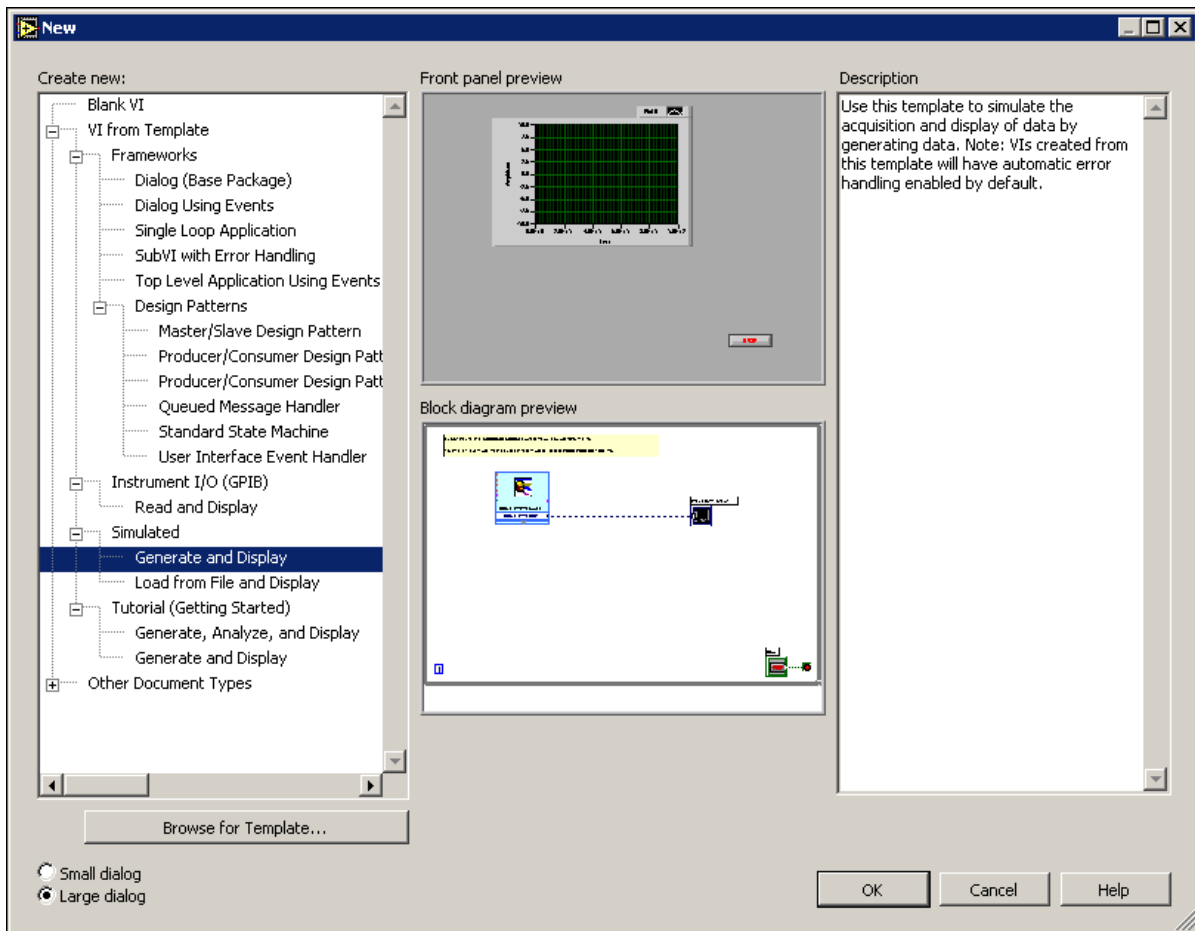

Figure 2.2: New Dialog Box

Click the OK button to open the template. You also can double-click the name of the template VI in the Create new list to open the template. If no template is available for the task you want to create, you can start with a blank VI and create a VI to accomplish the specific task. In the LabVIEW dialog box, click the arrow on the New button and select Blank VI from the shortcut menu or press the Ctrl-N keys to open a blank VI.

NOTE: You also can open a blank VI by selecting Blank VI from the Create new list in the New dialog box or by selecting File»New VI.

2.2.1.1 Open/Templates

Use the New dialog box to create different components in LabVIEW to help you build an application. You can start with a blank VI to write a VI from scratch, or start with a template to simplify the programming. The New dialog box includes the following components:

- **Create new** - Displays templates you can use to start building VIs and other LabVIEW

documents. Select from the following templates and click the OK button to start building a VI or other LabVIEW document.

- **Blank VI** - Opens a blank front panel and blank block diagram.
- **VI from Template** - Opens a front panel and block diagram with components you need to build different types of VIs.
- **Other Document Types** - Opens the tools you use to build other LabVIEW objects.
- **Browse for Template** - Displays the Browse dialog box so you can navigate to a VI, control, or template. If you previously have browsed for and selected a template from this dialog box, use the pull-down menu of the Browse button to select a template to reopen it.
- **Front panel preview** - Displays the front panel for the VI template you selected in the Create new list.
- **Block diagram preview** - Displays the block diagram for the VI template you selected in the Create new list.
- **Description** - Displays a description of the template you selected in the Create new list if the template includes a description.

2.2.1.2 Opening an Existing VI

You load a VI into memory by selecting File»Open. In the Choose the VI to open dialog box that appears, navigate to the VI you want to open.

The VIs you edit in this course are located in the C:\Exercises\LabVIEW Basics I directory. As the VI loads, a status dialog box similar to Figure 2.3 might appear.

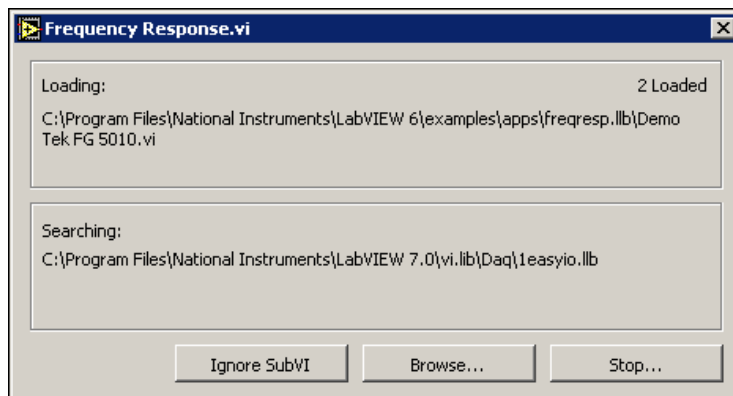

Figure 2.3

The Loading section lists the subVIs of the VI as they are loaded into memory. Number Loaded is the number of subVIs loaded into memory so far. You can cancel the load at any time by clicking the Stop button.

If LabVIEW cannot immediately locate a subVI, it begins searching through all directories specified by the VI Search Path. You can edit the VI Search Path by selecting Tools»Options

and selecting Paths from the top pull-down menu. The Searching section lists directories or VIs as LabVIEW searches through them. You can have LabVIEW ignore a subVI by clicking the Ignore SubVI button, or you can click the Browse button to search for the missing subVI.

2.2.1.3 Saving VIs

Select Save, Save As, Save All, or Save with Options from the File menu to save VIs as individual files or group several VIs together and save them in a VI library. VI library files end with the extension .llb. National Instruments recommends that you save VIs as individual files, organized in directories, especially if multiple developers are working on the same project.

LabVIEW uses the native file dialog boxes so they act similar to other applications on the computer. You can disable this feature by selecting Tools»Options and selecting Miscellaneous from the top pull-down menu. If you disable native file dialogs, LabVIEW uses its own platform-independent file dialog boxes with some convenient features, such as providing a list of recent paths and reducing the steps necessary to save VIs in VI libraries.

2.2.1.4 Moving VIs Across Platforms

You can transfer VIs from one platform to another, such as from Mac OS to Windows. LabVIEW automatically translates and recompiles the VIs on the new platform.

Because VIs are files, you can use any file transfer method or utility to move VIs between platforms. You can port VIs over networks using FTP, Z or XModem protocols, or similar utilities. Such network transfers eliminate the need for additional file translation software. If you port VIs using magnetic media, such as floppy disks or a moveable external hard drive, you need a generic file transfer utility program, such as the following:

- (*Windows*) MacDisk and TransferPro transfer Mac OS files to the PC format and vice versa.
- (*Mac OS*) DOS Mounter, MacLink, and Apple File Exchange convert PC files to the Mac OS format and vice versa.
- (*Sun*) PC File System (PCFS) converts PC files to the Sun format and vice versa.

NOTE: Certain operating system-specific VIs are not portable between platforms, such as DDE (Dynamic Data Exchange) VIs, ActiveX VIs, and AppleEvents.

Refer to the *Porting and Localizing LabVIEW VIs* Application Note, available by selecting Help»Search the LabVIEW Bookshelf, for more information about porting VIs.

2.2.2 Menus

The menus at the top of a VI window contain items common to other applications, such as Open, Save, Copy, and Paste, and other items specific to LabVIEW. Some menu items also list shortcut key combinations.

(*Mac OS*) The menus appear at the top of the screen.

(*Windows* and *UNIX*) The menus display only the most recently used items by default. Click the arrows at the bottom of a menu to display all items. You can display all menu items by default by selecting Tools»Options and selecting Miscellaneous from the top pull-down menu.

NOTE: Some menu items are unavailable while a VI is in run mode.

- The File menu contains items used for basic file operations, such as opening, closing, saving, and printing files.

- The Edit menu contains items that allow you to search for and modify LabVIEW files and their components.
- The Operate menu contains items you use to control the operation of VIs.
- The Tools menu contains items for configuring LabVIEW, your projects, and your VIs.
- The Browse menu contains items that allow you to view aspects of the current VI and its hierarchy.
- The Window menu contains items that allow you to configure the appearance of the current windows and palettes. You also can access the Error List window and view the contents of the clipboard.
- The Help menu contains items to explain and define LabVIEW features and other components, provide full LabVIEW documentation, and access National Instruments technical support.

2.2.3 Front Panel and Block Diagram Windows

When you open a blank VI, an untitled front panel window appears. This window displays the front panel and is one of the two LabVIEW windows you use to build a VI. The other window contains the block diagram. The illustration in Figure 2.4 shows a front panel and its corresponding block diagram with front panel and block diagram components.

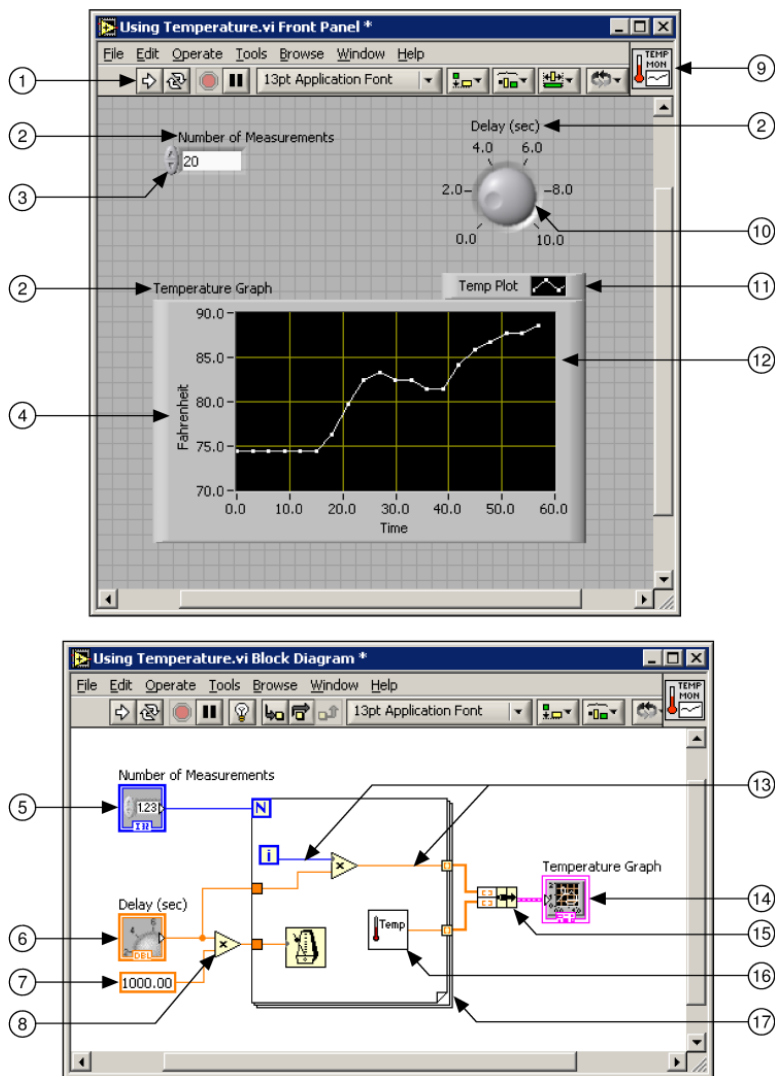



Figure 2.4: 1. Toolbar, 2. Owned Label, 3. Numeric Control, 4. Free Label, 5. Numeric Control Terminal, 6. Knob Terminal, 7. Numeric Constant, 8. Multiply Function, 9. Icon, 10. Knob Control, 11. Plot Legend, 12. XY Graph, 13. Wire Data Path, 14. XY Graph Terminal, 15. Bundle Function, 16. SubVI, 17. For Loop Structure

2.2.4 Front Panel Toolbar

Use the toolbar buttons to run and edit a VI. The toolbar in Figure 2.5 appears on the front panel.



Figure 2.5

 Click the Run button to run a VI. LabVIEW compiles the VI, if necessary. You can run a VI if the Run button appears as a solid white arrow. The solid white arrow, shown above, also indicates you can use the VI as a subVI if you create a connector pane for the VI.

 While the VI runs, the Run button appears as shown at left if the VI is a top-level VI, meaning it has no callers and therefore is not a subVI.



If the VI that is running is a subVI, the Run button appears as shown at left.



The Run button appears broken, shown at left, when the VI you are creating or editing contains errors. If the Run button still appears broken after you finish wiring the block diagram, the VI is broken and cannot run. Click this button to display the Error list window, which lists all errors and warnings.



Click the Run Continuously button, shown at left, to run the VI until you abort or pause execution. You also can click the button again to disable continuous running.



While the VI runs, the Abort Execution button, shown at left, appears. Click this button to stop the VI immediately if there is no other way to stop the VI. If more than one running top-level VI uses the VI, the button is dimmed.

NOTE: Avoid using the Abort Execution button to stop a VI. Either let the VI complete its data flow or design a method to stop the VI programmatically. By doing so, the VI is at a known state. For example, place a button on the front panel that stops the VI when you click it.



Click the Pause button, shown at left, to pause a running VI. When you click the Pause button, LabVIEW highlights on the block diagram the location where you paused execution, and the Pause button appears red. Click the button again to continue running the VI.

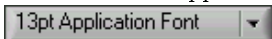

Select the Text Settings pull-down menu, shown at left, to change the font settings for the selected portions of the VI, including size, style, and color.



Select the Align Objects pull-down menu, shown at left, to align objects along axes, including vertical, top edge, left, and so on.



Select the Distribute Objects pull-down menu, shown at left, to space objects evenly, including gaps, compression, and so on.



Select the Resize Objects pull-down menu, shown at left, to resize multiple front panel objects to the same size.



Select the Reorder pull-down menu, shown at left, when you have objects that overlap each other and you want to define which one is in front or back of another. Select one of the objects with the Positioning tool and then select from Move Forward, Move Backward, Move To Front, and Move To Back.



Select the Show Context Help Window button, shown at left, to toggle the display of the Context Help window.



Type appears to remind you that a new value is available to replace an old value. The Enter button disappears when you click it, press the Enter key, or click the front panel or block diagram workspace.

2.2.5 Block Diagram Toolbar

When you run a VI, buttons appear on the block diagram toolbar that you can use to debug the VI. The toolbar in Figure 2.6 appears on the block diagram.

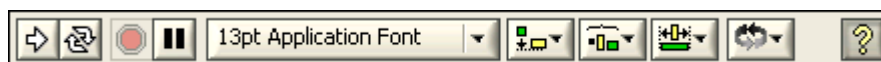

Figure 2.6



Click the Highlight Execution button, shown at left, to display an animation of the block diagram execution when you click the Run button. See the flow of data through the block diagram. Click the button again to disable execution highlighting.



Click the Step Into button, shown at left, to open a node and pause. When you click the Step Into button again, it executes the first action and pauses at the next action of the subVI or structure. You also can press the Ctrl and down arrow keys. Single-stepping through a VI steps through the VI node by node. Each node blinks to denote when it is ready to execute. By stepping into the node, you are ready to single-step inside the node.



Click the Step Over button, shown at left, to execute a node and pause at the next node. You also can press the Ctrl and right arrow keys. By stepping over the node, you execute the node without single-stepping through the node.



Click the Step Out button, shown at left, to finish executing the current node and pause. When the VI finishes executing, the Step Out button becomes dimmed. You also can press the Ctrl and up arrow keys. By stepping out of a node, you complete single-stepping through the node and go to the next node.



The Warning button, shown at left, appears if a VI includes a warning and you placed a checkmark in the Show Warnings checkbox in the Error List window. A warning indicates there is a potential problem with the block diagram, but it does not stop the VI from running.

2.2.6 Palettes

LabVIEW has graphical, floating palettes to help you create and run VIs. The three palettes include the Tools, Controls, and Functions palettes. You can place these palettes anywhere on the screen.

2.2.6.1 Tools Palette

You can create, modify, and debug VIs using the tools located on the floating Tools (Figure 2.7) palette. The Tools palette is available on both the front panel and the block diagram. A tool is a special operating mode of the mouse cursor. The cursor corresponds to the icon of the tool selected in the Tools palette. Use the tools to operate and modify front panel and block diagram objects.

Select **Window**»**Show Tools Palette** to display the Tools palette.

NOTE: Press the Shift key and right-click to display a temporary version of the Tools palette at the location of the cursor.



Figure 2.7: Tools Palette

If automatic tool selection is enabled and you move the cursor over objects on the front panel or block diagram, LabVIEW automatically selects the corresponding tool from the Tools palette. You can disable automatic tool selection and select a tool manually by clicking the tool you want on the Tools palette.



If you want to use the Tab key to cycle through the four most common tools on the Tools palette, click the Automatic Tool Selection button, shown at left, on the Tools palette to disable automatic tool selection. Press the Shift-Tab keys or click the Automatic Tool Selection button to enable automatic tool selection again. You also can manually select a tool on the Tools palette to disable automatic tool selection. Press the Tab or Shift-Tab keys or click the Automatic Tool Selection button on the Tools palette to enable automatic tool selection again. If automatic tool selection is disabled, you can press the spacebar to switch to the next most useful tool.



Use the Operating tool, shown at left, to change the values of a control or select the text within a control. The Operating tool changes to the icon shown at left when it moves over a text control, such as a numeric or string control.



Use the Positioning tool, shown at left, to select, move, or resize objects. The Positioning tool changes to resizing handles when it moves over the edge of a resizable object.

 Use the Labeling tool, shown at left, to edit text and create free labels. The Labeling tool changes to the following icon when you create free labels.



Use the Wiring tool, shown at left, to wire objects together on the block diagram.



Use the Object Shortcut Menu, shown at left, tool to access an object shortcut menu with the left mouse button.



Use the Scrolling tool, shown at left, to scroll through windows without using scrollbars.



Use the Breakpoint tool, shown at left, to set breakpoints on VIs, functions, nodes, wires, and structures to pause execution at that location.



Use the Probe tool, shown at left, to create probes on wires on the block diagram. Use the Probe tool to check intermediate values in a VI that produces questionable or unexpected results.



Use the Color Copy tool, shown at left, to copy colors for pasting with the Coloring tool.



Use the Coloring tool, shown at left, to color an object. It also displays the current foreground and background color settings.

2.2.6.2 Controls and Functions Palettes

The Controls and Functions palettes contain subpalettes of objects you can use to create a VI. When you click a subpalette icon, the entire palette changes to the subpalette you selected. To use an object on the palettes, click the object and place it on the front panel or block diagram.

The Controls palette, shown in Figure 2.8, is available only on the front panel. The Controls palette contains the controls and indicators you use to build the front panel. Refer to the Front Panel (Section 2.3) section for more information about the using the Controls palette on the front panel. The controls and indicators located on the Controls palette depend on the palette view currently selected.

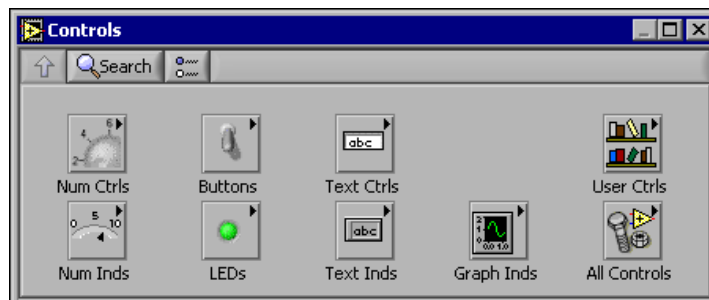

Figure 2.8: Controls Palette

The Functions palette, shown in the Figure 2.9, is available only on the block diagram. The Functions palette contains the VIs and functions you use to build the block diagram. Refer to the Block Diagram (Section 2.4) section of this lesson for more information about using the Functions palette on the block diagram. The VIs and functions located on the Functions palette depend on the palette view currently selected. The VIs and functions are located on subpalettes based on the types of VIs and functions.

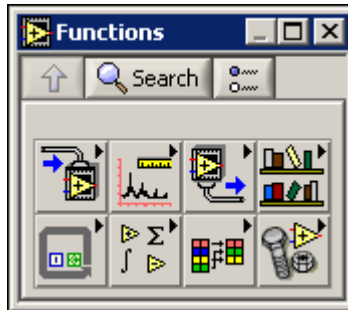

Figure 2.9: Functions Palette

2.2.6.3 Changing Palette Views



Use the Options button on the Controls or Functions palette toolbar to change to another palette view or format:



1. Click the Options button, shown at left, on the Controls or Functions palette toolbar to display the Controls/Functions Palettes page of the Options dialog box.
2. Select a palette view from the Palette View pull-down menu.
3. Select a format from the Format pull-down menu, such as Standard, All Icons, All Text, or Icons and Text.
4. Click the OK button. The Controls and Functions palettes change to the palette view and format you selected.

2.2.6.4 Searching for Controls, VIs, and Functions

Use the following navigation buttons on the Controls and Functions palettes to navigate and search for controls, VIs, and functions:

- **Up to Owning Palette** -  Navigates up one level in the palette hierarchy.
- **Search** -  Changes the palette to search mode. In search mode, you can perform text-based searches to locate controls, VIs, or functions on the palettes. For example, if you want to find the Random Number function, click the Search button on the Functions palette toolbar

and start typing Random Number in the text box at the top of the palette. LabVIEW lists all matching items that either start with or contain the text you typed. You can click one of the search results and drag it to the block diagram, as shown in Figure 2.10.

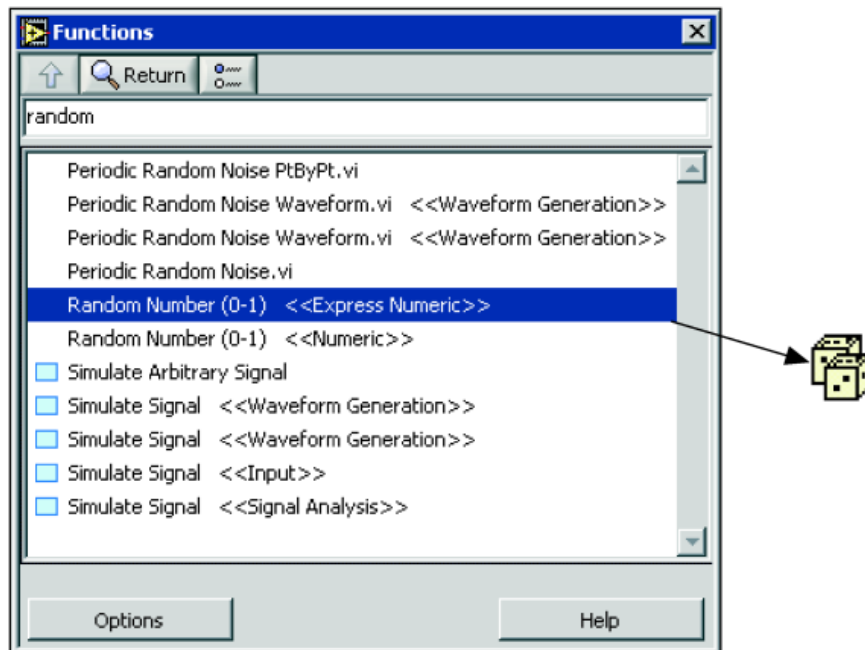

Figure 2.10

Double-click the search result to highlight its location on the palette. You then can click the Up to Owning Palette button to view the hierarchy of where the object resides.

2.2.7 Shortcut Menus

The most often-used menu is the object shortcut menu. All LabVIEW objects and empty space on the front panel and block diagram have associated shortcut menus. Use the shortcut menu items to change the look or behavior of front panel and block diagram objects. To access the shortcut menu, right-click the object, front panel, or block diagram. The shortcut menu for a meter is shown in Figure 2.11.

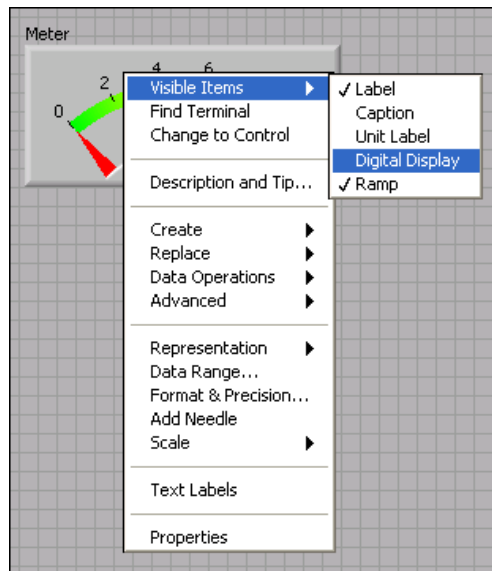

Figure 2.11: Meter Short cut Menu

2.2.7.1 Property Dialog Boxes

Front panel objects also have property dialog boxes that you can use to change the look or behavior of front panel objects. Right-click a front panel object and select Properties from the shortcut menu to access the property dialog box for an object. Figure 2.12 shows the property dialog box for the meter in the previous figure. The options available on the property dialog box for an object are similar to the options available on the shortcut menu for that object.

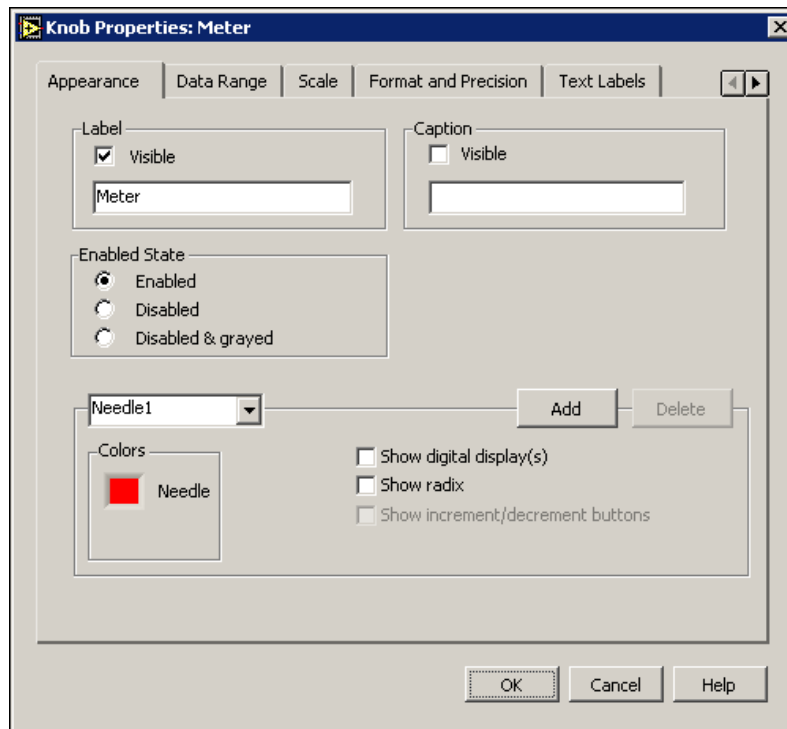

Figure 2.12: Meter Property Dialog Box

2.3 Front Panel

The front panel is the user interface of the VI. Figure 2.13 shows an example of a front panel.

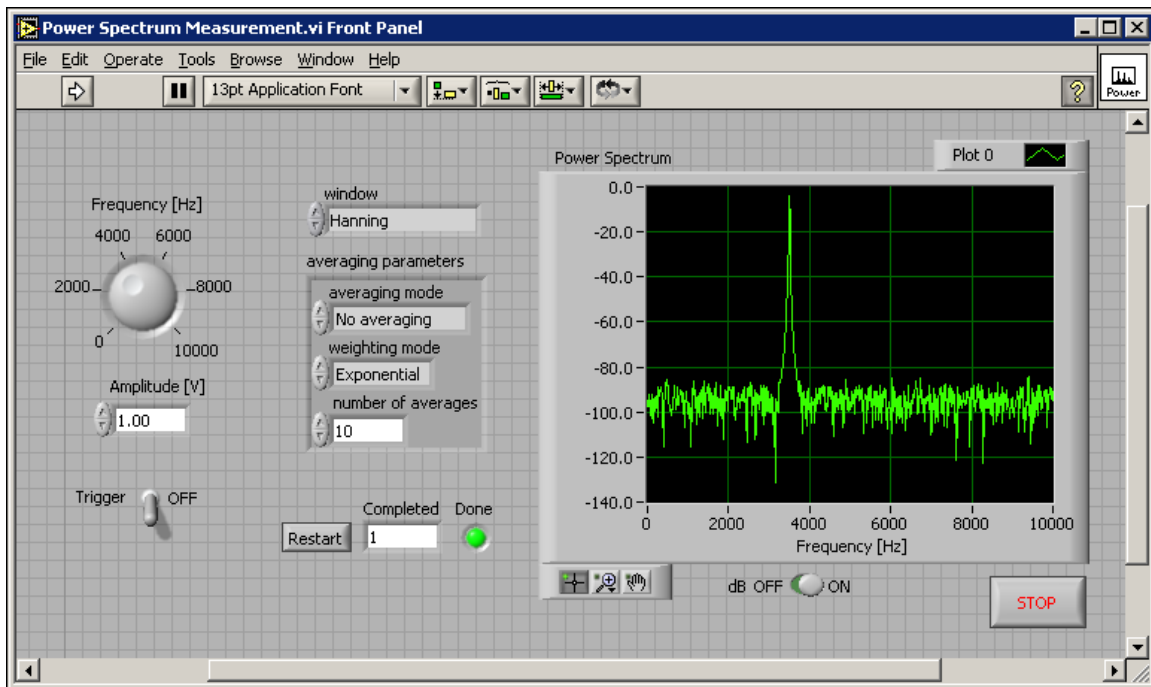

Figure 2.13: Example of a Front Panel

2.3.1 Controls and Indicators

You build the front panel with controls and indicators, which are the interactive input and output terminals of the VI, respectively. Controls are knobs, push buttons, dials, and other input devices. Indicators are graphs, LEDs, and other displays. Controls simulate instrument input devices and supply data to the block diagram of the VI. Indicators simulate instrument output devices and display data the block diagram acquires or generates.

2.3.1.1 Controls Palette

The Controls palette is available only on the front panel. The Controls palette contains the controls and indicators you use to create the front panel. Select **Window**»**Show Controls Palette** or right-click the front panel workspace to display the Controls palette. Tack down the Controls palette by clicking the thumbtack on the top left corner of the palette. By default, the Controls palette starts in the Express view.

The Express palette view includes subpalettes on the top level of the Controls and Functions palettes that contain Express VIs and other objects you need to build common measurement applications. The All Controls and All Functions subpalettes contain the complete set of built-in controls, indicators, VIs, and functions.

The Advanced palette view includes subpalettes on the top level of the Controls and Functions palettes that contain the complete set of built-in controls, indicators, VIs, and functions. The Express subpalettes contain Express VIs and other objects you need to build common measurement applications.

NOTE: In the Express palette view, toolsets and modules do not install subpalettes on the top level of the Controls and Functions palettes. Instead, toolsets and modules install on the All Controls and All Functions subpalettes. In the Advanced palette view, toolsets and modules install subpalettes on the top level.

Click the Options button on the Controls or Functions palette to change to another palette view or format.

2.3.1.1.1 Numeric Controls and Indicators

The two most commonly used numeric objects are the numeric control and the numeric indicator, as shown in Figure 2.14.

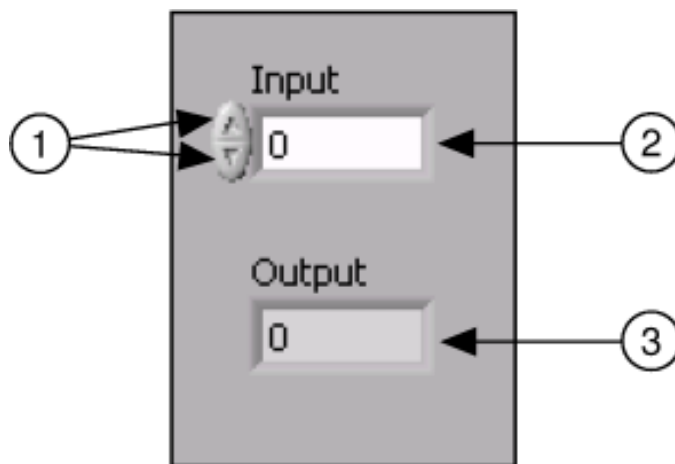

Figure 2.14: 1. Increment and Decrement Buttons, 2. Numeric Control, 3. Numeric Indicator

To enter or change values in a numeric control, click the increment and decrement buttons with the Operating tool or double-click the number with either the Labeling tool or the Operating tool, type a new number, and press the Enter key.

2.3.1.1.2 Boolean Controls and Indicators

Use Boolean controls and indicators to enter and display Boolean (True or False) values. Boolean objects simulate switches, push buttons, and LEDs. The most common Boolean objects are the vertical toggle switch and the round LED, as shown in Figure 2.15.

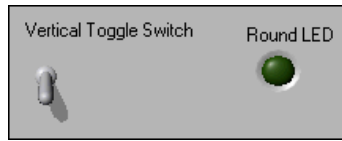

Figure 2.15

2.4 Block Diagram

After you build the front panel, you add code using graphical representations of functions to control the front panel objects. The block diagram contains this graphical source code. Front panel objects appear as terminals, on the block diagram. Block diagram objects include terminals, subVIs, functions, constants, structures, and wires, which transfer data among other block diagram objects.

The VI in Figure 2.16 shows several primary block diagram objects—nodes, terminals, and wires.

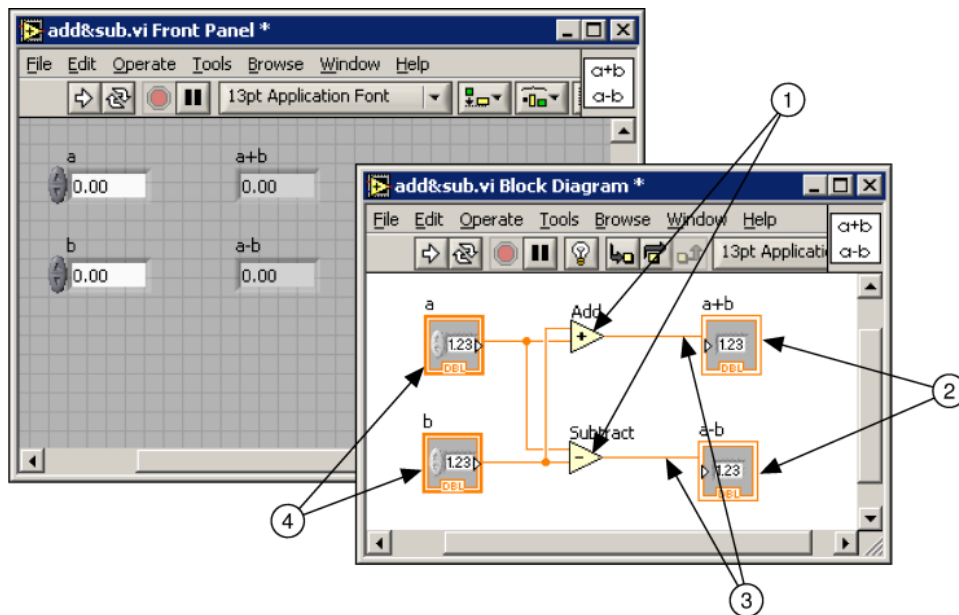

Figure 2.16: 1. Nodes, 2. Indicator Terminals, 3. Wires, 4. Control Terminals

2.4.1 Functions Palette

The Functions palette is available only on the block diagram. The Functions palette contains the VIs and functions you use to build the block diagram. Select **Window**»**Show Functions Palette** or right-click the block diagram workspace to display the Functions palette. Tack down the Functions

palette by clicking the thumbtack on the top left corner of the palette. By default, the Functions palette starts in the Express view.

2.4.2 Express VIs, VIs, and Functions

LabVIEW uses colored icons to distinguish between Express VIs, VIs, and functions on the block diagram. By default, icons for Express VIs appear on the block diagram as expandable nodes with icons surrounded by a blue field. Icons for VIs have white backgrounds, and icons for functions have pale yellow backgrounds.

By default, most functions and VIs on the block diagram appear as icons that are not expandable, unlike Express VIs.

2.4.2.1 Express VIs

Use Express VIs for common measurement tasks. Express VIs are nodes that require minimal wiring because you configure them with dialog boxes. You can save the configuration of an Express VI as a subVI. Refer to *Building the Block Diagram*, of the *LabVIEW User Manual* for more information about creating subVIs from Express VIs.

2.4.2.2 VIs

When you place a VI on the block diagram, LabVIEW considers the VI to be a subVI. When you double-click a subVI, its front panel and block diagram appear, rather than a dialog box in which you can configure options. The front panel includes controls and indicators. The block diagram includes wires, front panel icons, functions, possibly subVIs, and other LabVIEW objects.

The upper right corner of the front panel and block diagram displays the icon for the VI. This is the icon that appears when you place the VI on the block diagram.

You can create a VI to use as a subVI. Refer to Modular Programming (Section 3.1) for more information about creating VIs and configuring them as subVIs.

2.4.2.3 Functions

Functions are the fundamental operating elements of LabVIEW. Functions do not have front panels or block diagrams but do have connector panes. Double-clicking a function only selects the function.

2.4.3 Nodes

Nodes are objects on the block diagram that have inputs and/or outputs and perform operations when a VI runs. They are analogous to statements, operators, functions, and subroutines in text-based programming languages. Nodes can be functions, subVIs, or structures. Structures are process control elements, such as Case structures, For Loops, or While Loops. The Add and Subtract functions in Figure 2.16 are function nodes.

2.4.3.1 Expandable Nodes versus Icons

You can display VIs and Express VIs as icons or as expandable nodes. Expandable nodes appear as icons surrounded by a colored field. SubVIs appear with a yellow field, and Express VIs appear with a blue field. Use icons, such as the Basic Function Generator VI icon if you want to conserve space on the block diagram. Use expandable nodes, such as the Basic Function Generator VI expandable node to make wiring easier and to aid in documenting block diagrams. By default, subVIs appear as icons on the block diagram, and Express VIs appear as expandable nodes.

To display a subVI or Express VI as an expandable node, right-click the subVI or Express VI and select View As Icon from the shortcut menu to remove the checkmark.

You can resize the expandable node to make wiring even easier, but it also takes a large amount of space on the block diagram. Complete the following steps to resize a node on the block diagram.

1. Move the Positioning tool over the node. Resizing handles appear at the top and bottom of the node.
2. Move the cursor over a resizing handle to change the cursor to the resizing cursor.
3. Use the resizing cursor to drag the border of the node down to display additional terminals.
4. Release the mouse button.

To cancel a resizing operation, drag the node border past the block diagram window before you release the mouse button.

Figure 2.17 shows the Basic Function Generator VI as a resized expandable node.

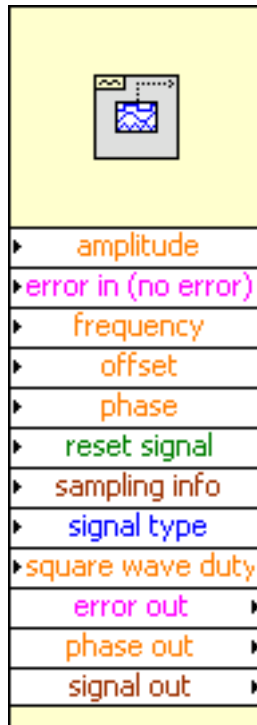

Figure 2.17

NOTE: If you display a subVI or Express VI as an expandable node, you cannot display the terminals for that node and you cannot enable database access for that node.

2.4.3.2 Terminals



Front panel objects appear as terminals on the block diagram. The terminals represent the data type of the control or indicator. You can configure front panel controls or indicators to appear as icon or data type terminals on the block diagram. By default, front panel objects appear as icon terminals. For example, a knob icon terminal, shown at left, represents a knob on the front panel. The DBL at the bottom of the terminal represents a data type of double-precision, floating-point numeric. To display a terminal as a data type on the block diagram, right-click the terminal and select View As Icon from the shortcut menu to remove the checkmark. A DBL data type terminal, shown above at left, represents a double-precision, floating-point numeric control or indicator.



Terminals are entry and exit ports that exchange information between the front panel and block diagram. Terminals are analogous to parameters and constants in text-based programming languages. Types of terminals include control or indicator terminals and node terminals. Control and indicator terminals belong to front panel controls and indicators. Data you enter into the front panel controls (a and b in Figure 2.16) enter the block diagram through the control terminals. The data then enter the Add and Subtract functions. When the Add and Subtract functions complete their internal calculations, they produce new data values. The data flow to the indicator terminals, where they exit the block diagram, reenter the front panel, and appear in front panel indicators ($a + b$ and $a - b$ in Figure 2.16). The terminals in Figure 2.16 belong to four front panel controls and indicators. The connector panes of the Add and Subtract functions, shown in pg 25, have three node terminals. To display the terminals of the function on the block diagram, right-click the function node and select Visible Items»Terminals from the shortcut menu.

2.4.3.3 Wires

You transfer data among block diagram objects through wires. Wires are analogous to variables in text-based programming languages. In Figure 2.16, wires connect the control and indicator terminals to the Add and Subtract functions. Each wire has a single data source, but you can wire it to many VIs and functions that read the data. Wires are different colors, styles, and thicknesses, depending on their data types. A broken wire appears as a dashed black line with a red X in the middle. The examples in pg 25 are the most common wire types.

Wire Type	Scalar	1D Array	2D Array	Color
Numeric				Orange (floating-point), Blue (integer)
Boolean				Green
String				Pink

In LabVIEW, you use wires to connect multiple terminals together to pass data in a VI. The wires must be connected to inputs and outputs that are compatible with the data that is transferred with the wire. For example, you cannot wire an array output to a numeric input. In addition the direction of the wires must be correct. The wires must be connected to only one input and at least one output. For example, you cannot wire two indicators together. The components that determine wiring compatibility include the data type of the control and/or indicator and the data type of the terminal.

2.4.3.3.1 Data Types

Data types indicate what objects, inputs, and outputs you can wire together. For example, a switch has a green border so you can wire a switch to any input with a green label on an Express VI. A knob has an orange border so you can wire a knob to any input with an orange label. However, you cannot wire an orange knob to an input with a green label. Notice the wires are the same color as the terminal.



The dynamic data type stores the information generated or acquired by an Express VI. The dynamic data type appears as a dark blue terminal, shown at left. Most Express VIs accept and/or return the dynamic data type. You can wire the dynamic data type to any indicator or input that accepts numeric, waveform, or Boolean data. Wire the dynamic data type to an indicator that can best present the data. Indicators include a graph, chart, or numeric indicator.

Most other VIs and functions in LabVIEW do not accept the dynamic data type. To use a built-in VI or function to analyze or process the data the dynamic data type includes, you must convert the dynamic data type.



Use the Convert from Dynamic Data Express VI, shown at left, to convert the dynamic data type to numeric, Boolean, waveform, and array data types for use with other VIs and functions. When you place the Convert from Dynamic Data Express VI on the block diagram, the Configure Convert from Dynamic Data dialog box appears. The Configure Convert from Dynamic Data dialog box displays options that let you specify how you want to format the data that the Convert from Dynamic Data Express VI returns.

When you wire a dynamic data type to an array indicator, LabVIEW automatically places the Convert from Dynamic Data Express VI on the block diagram. Double-click the Convert from Dynamic Data Express VI to open the Configure Convert from Dynamic Data dialog box to control how the data appears in the array.

Use the Convert to Dynamic Data Express VI to convert numeric, Boolean, waveform, and array data types to the dynamic data type for use with Express VIs. When you place the Convert to Dynamic Data Express VI on the block diagram, the Configure Convert to Dynamic Data dialog box appears. Use this dialog box to select the kind of data to convert to the dynamic data type.

2.4.3.3.2 Automatically Wiring Objects

LabVIEW automatically wires objects as you place them on the block diagram. You also can automatically wire objects already on the block diagram. LabVIEW connects the terminals that best match and leaves terminals that do not match unconnected.

As you move a selected object close to other objects on the block diagram, LabVIEW draws temporary wires to show you valid connections. When you release the mouse button to place the object on the block diagram, LabVIEW automatically connects the wires.

Toggle automatic wiring by pressing the spacebar while you move an object using the Positioning tool. You can adjust the automatic wiring settings by selecting Tools»Options and selecting Block Diagram from the top pull-down menu.

2.4.3.3.3 Manually Wiring Objects

When you pass the Wiring tool over a terminal, a tip strip appears with the name of the terminal. In addition, the terminal blinks in the Context Help window and on the icon to help you verify that you are wiring to the correct terminal.

2.5 Acquiring a Signal VI

Exercise 2.1:

In the following exercise, you will build a VI that generates a signal and displays that signal in a graph. LabVIEW provides templates containing information from which you can build a VI. These templates help you get started with LabVIEW.

Complete the following steps to create a VI that generates a signal and displays it on the front panel.

1. Launch LabVIEW.
2. In the LabVIEW dialog box that appears, shown in Figure 2.18, click the New button to display the New dialog box.



Figure 2.18

3. Select VI from Template»Tutorial (Getting Started)»Generate and Display in the Create new list. This template VI generates and displays a signal. Notice that previews of the template VI appear in the Front panel preview and the Block diagram preview sections. The Figure 2.19 shows the New dialog box and the Generate and Display template VI.

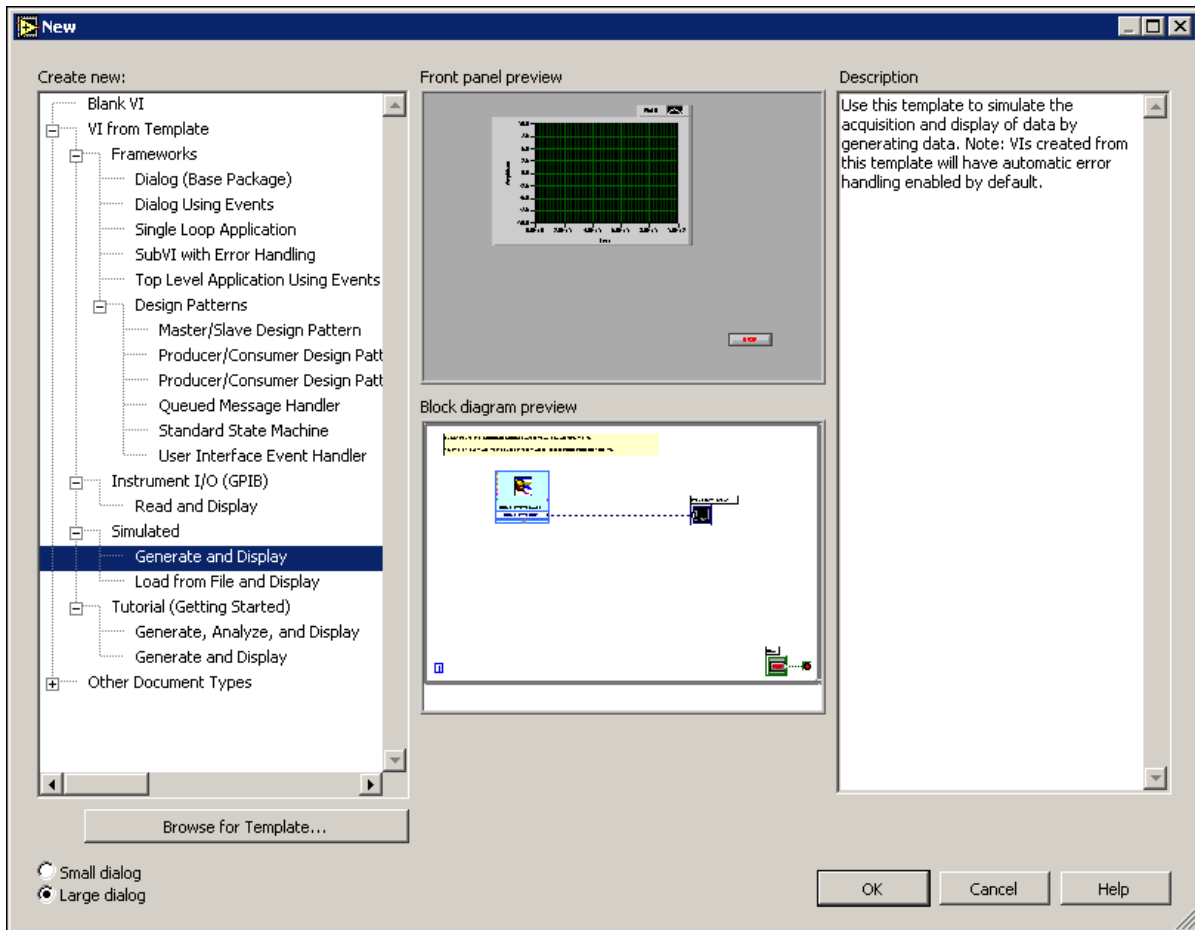



Figure 2.19

4. Click the OK button to open the template. You also can double-click the name of the template VI in the Create new list to open the template.
5. Examine the front panel of the VI. The user interface, or front panel, appears with a gray background and includes controls and indicators. The title bar of the front panel indicates that this window is the front panel for the Generate and Display VI.

NOTE: If the front panel is not visible, you can display the front panel by selecting Window»Show Front Panel.

6. Examine the block diagram of the VI. The block diagram appears with a white background and includes VIs and structures that control the front panel objects. The title bar of the block diagram indicates that this window is the block diagram for the Generate and Display VI.

NOTE: If the block diagram is not visible, you can display the block diagram by selecting Window»Show Block Diagram.

7.  On the front panel toolbar, click the Run button, shown at left. Notice that a sine wave appears on the graph.



8. Stop the VI by clicking the Stop button, shown at left, on the front panel.

2.5.1 Adding a Control to the Front Panel

Controls on the front panel simulate the input devices on a physical instrument and supply data to the block diagram of the VI. Many physical instruments have knobs you can turn to change an input value. Complete the following steps to add a knob control to the front panel.

TIP: Throughout these exercises, you can undo recent edits by selecting Edit>>Undo or pressing the Ctrl-Z keys.

1. If the Controls palette is not visible on the front panel, select Window>>Show Controls Palette to display it.
2. Move the cursor over the icons on the Controls palette to locate the Numeric Controls palette. Notice that when you move the cursor over icons on the Controls palette, the name of that subpalette appears in the gray space above all the icons on the palette. When you idle the cursor over any icon on any palette, the full name of the subpalette, control, or indicator appears.
3. Click the Numeric Controls icon to access the Numeric Controls palette.
4. Select the knob control on the Numeric Controls palette and place it on the front panel to the left of the waveform graph. You will use this knob in a later exercise to control the amplitude of a signal.
5. Select File>>Save As and save this VI as Acquiring a Signal.vi in the C:\Exercises\LabVIEW Basics I directory.

NOTE: Save all the VIs you edit or create in this course in the C:\Exercises\LabVIEW Basics I directory.

2.5.2 Changing the Signal Type

The block diagram has a blue icon labeled Simulate Signal. This icon represents the Simulate Signal Express VI. The Simulate Signal Express VI simulates a sine wave by default. Complete the following steps to change this signal to a sawtooth wave.

1. Display the block diagram by selecting Window>>Show Block Diagram or by clicking



the block diagram. Notice the Simulate Signal Express VI, shown in pg 29. An Express VI is a component of the block diagram that you can configure to perform common measurement tasks. The Simulate Signal Express VI simulates a signal based on the configuration that you specify.

2. Right-click the Simulate Signal Express VI and select Properties from the shortcut menu to display the Configure Simulate Signal dialog box.

3. Select Sawtooth from the Signal type pull-down menu. Notice that the waveform on the graph in the Result Preview section changes to a sawtooth wave. The Configure Simulate Signal dialog box should appear similar to Figure 2.20.

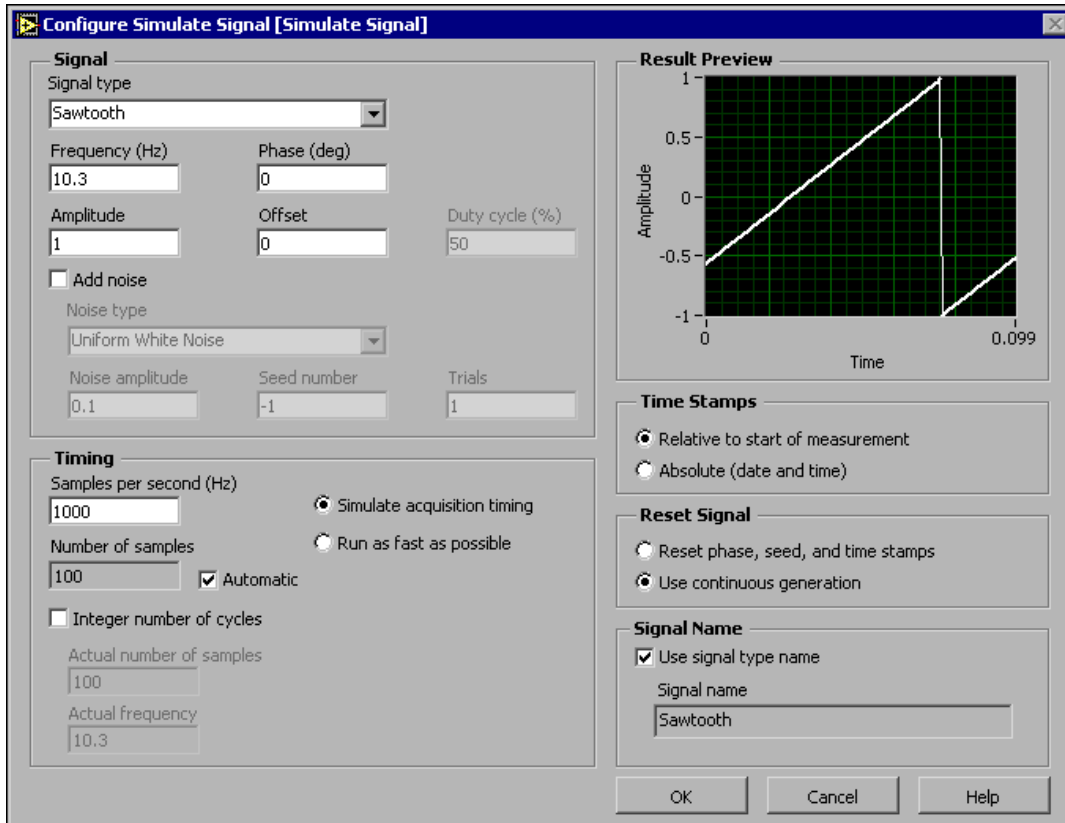

Figure 2.20

4. Click the OK button to apply the current configuration and close the Configure Simulate Signal dialog box.
5. Move the cursor over the down arrows at the bottom of the Simulate Signal Express VI.



6. When a double-headed arrow appears, shown at left, click and drag the border of the Express VI until the Amplitude input appears. Notice how you expanded the Simulate Signal Express VI to display a new input. Because the Amplitude input appears on the block diagram, you can configure the amplitude of the sawtooth wave on the block diagram. In Figure 2.20, notice how Amplitude is an option in the Configure Simulate Signal dialog box. When inputs, such as Amplitude, appear on the block diagram and in the configuration dialog box, you can configure the inputs in either location.

2.5.3 Wiring Objects on the Block Diagram

To use the knob control to change the amplitude of the signal, you must connect the two objects on the block diagram. Complete the following steps to wire the knob to the Amplitude input on the Simulate Signal Express VI.



1. Move the cursor over the Knob terminal, shown at left, until the Positioning tool appears.  Notice how the cursor becomes an arrow, or the Positioning tool, shown in pg 31. Use the Positioning tool to select, position, and resize objects.



2. Click the Knob terminal to select it, then drag the terminal to the left of the Simulate Signal Express VI. Make sure the Knob terminal is inside the loop, shown in pg 31. The terminals are representations of front panel controls and indicators. Terminals are entry and exit ports that exchange information between the front panel and block diagram.
3. Deselect the Knob terminal by clicking a blank space on the block diagram.



4. Move the cursor over the arrow of the Knob terminal, shown in pg 31. Notice how the cursor becomes a wire spool, or the Wiring tool, shown at left. Use the Wiring tool to wire objects together on the block diagram.

NOTE: The cursor does not switch to another tool while an object is selected.

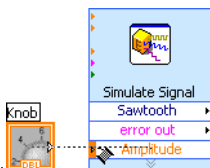

5. When the Wiring tool appears, click the arrow and then click the Amplitude input of the Simulate Signal Express VI, shown in pg 31, to wire the two objects together. Notice that a wire appears and connects the two objects. Data flows along this wire from the terminal to the Express VI.

6. Select File>>Save to save this VI.



2.5.4 Running the VI

Running a VI executes your solution. Complete the following steps to run the Acquiring a Signal VI.

1. Display the front panel by selecting Window>>Show Front Panel or by clicking the front panel.

TIP: Press the Ctrl-E keys to switch from the front panel to the block diagram or from the block diagram to the front panel.

2. Click the Run button.

3. Move the cursor over the knob control.  Notice how the cursor becomes a hand, or the Operating tool, shown at left. Use the Operating tool to change the value of a control or select the text within a control.
4. Using the Operating tool, turn the knob to adjust the amplitude of the sawtooth wave. Notice how the amplitude of the sawtooth wave changes as you turn the knob. Also notice that the y-axis on the graph autoscales to account for the change in amplitude.  To indicate that the VI is running, the Run button changes to a darkened arrow, shown at left. You cannot edit the front panel or block diagram while the VI runs.
5.  Click the Stop button, shown at left, to stop the VI.

NOTE: Although Abort Execution button looks like a stop button, the Abort Execution button does not always properly close the VI. National Instruments recommends stopping your VIs using the Stop button on the front panel. Use the Abort Execution button only when errors prevent you from terminating the application using the Stop button.

2.5.5 Modifying the Signal

Complete the following steps to add scaling to the signal and display the results in the graph on the front panel.

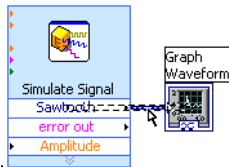

1. On the block diagram, use the Positioning tool to double-click the wire that connects the Simulate Signal Express VI to the Waveform Graph terminal shown in pg 32.
2. Press the Delete key to delete this wire.
3. If the Functions palette is not visible on the block diagram, select Window>>Show Functions Palette to display it.



4. Select the Scaling and Mapping Express VI, shown at left, on the Arithmetic & Comparison palette and place it on the block diagram inside the loop between the Simulate Signal Express VI and the Waveform Graph terminal. If there is no room between the Express VI and the terminal, move the Waveform Graph terminal to the right. Notice that the Configure Scaling and Mapping dialog box automatically opens when you place the Express VI on the block diagram.
5. Define the value of the scaling factor by entering 10 in the Slope (m) text box. The Configure Scaling and Mapping dialog box should appear similar to Figure 2.21.

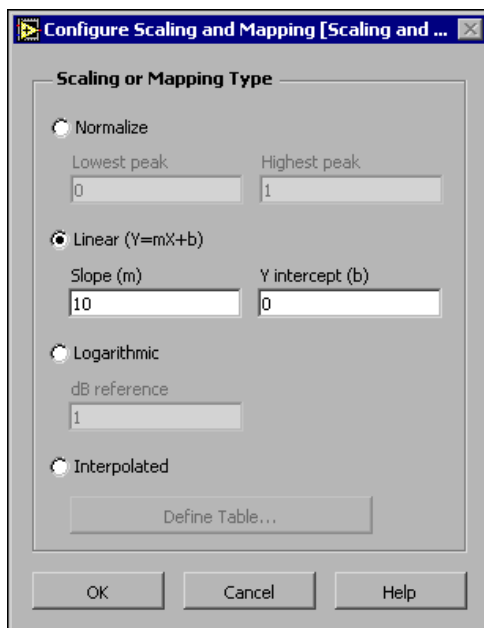
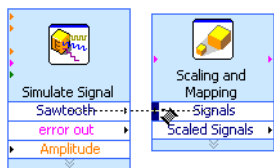

Figure 2.21

6. Click the OK button to apply the current configuration and close the Configure Scaling and Mapping dialog box.
7. Move the cursor over the arrow on the Sawtooth output of the Simulate Signal Express VI.



8. When the Wiring tool appears, click the arrow and then click the arrow on the Signals input of the Scaling and Mapping Express VI, shown in pg 33, to wire the two objects together.
9. Using the Wiring tool, wire the Scaled Signals output of the Scaling and Mapping Express VI to the Waveform Graph terminal. Notice the wires connecting the Express VIs and terminals. The arrows on the Express VIs and terminals indicate the direction that the data flows along these wires. The block diagram should appear similar to Figure 2.22.

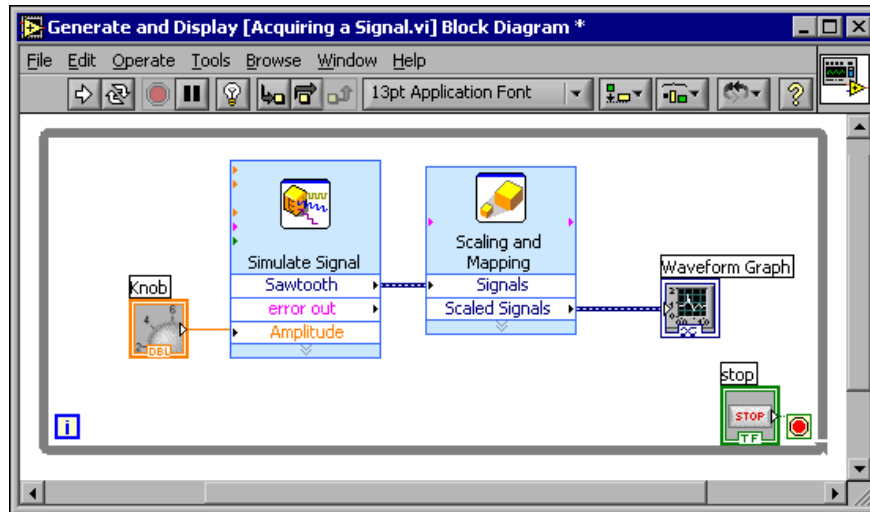

Figure 2.22

NOTE: The terminals in the block diagram are set to display as icons. To display a terminal as a data type on the block diagram, right-click the terminal and select View As Icon from the shortcut menu to remove the checkmark.

10. Select File » Save to save this VI.

2.5.6 Displaying Two Signals on the Graph

To compare the signal generated by the Simulate Signal Express VI and the signal modified by the Scaling and Mapping Express VI on the same graph, use the Merge Signals function. Complete the following steps to display two signals on the same graph.

1. Move the cursor over the arrow on the Sawtooth output of the Simulate Signal Express VI.
2. Using the Wiring tool, wire the Sawtooth output to the Waveform Graph terminal.



The Merge Signals function, shown in pg 34, appears where the two wires connect. This function takes the two separate signals and combines them so that both can be displayed on the same graph. The block diagram should appear similar to Figure 2.23.

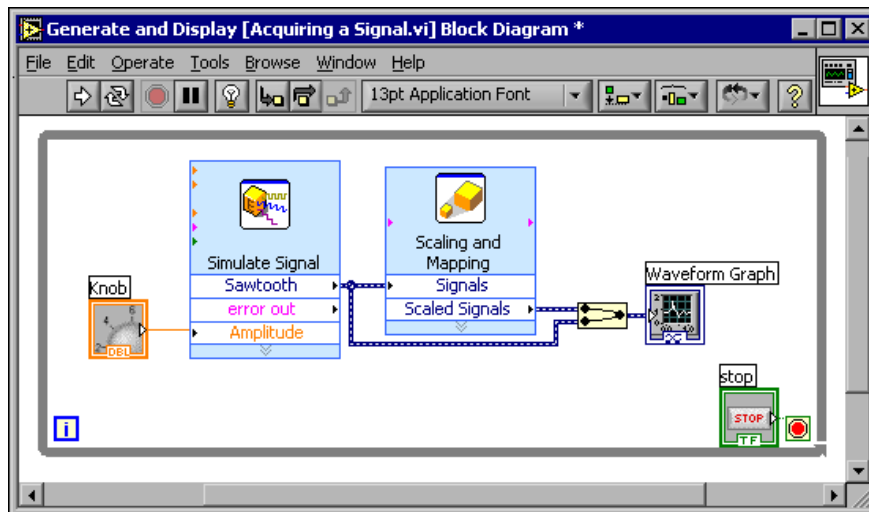

Figure 2.23

3. Select File » Save to save this VI. You also can press the Ctrl-S keys to save a VI.
4. Return to the front panel, run the VI, and turn the knob control. Notice that the graph plots the sawtooth wave and the scaled signal. Also notice that the maximum value on the y-axis automatically changes to be 10 times the knob value. This scaling occurs because you set the slope to 10 in the Scaling and Mapping Express VI.
5. Click the Stop button.

2.5.7 Customizing the Knob

The knob control changes the amplitude of the sawtooth wave so labeling it Amplitude accurately describes the function of the knob. Complete the following steps to customize the appearance of a control on the front panel.

1. Right-click the knob and select Properties from the shortcut menu to display the Knob Properties dialog box.
2. In the Label section on the Appearance tab, delete the label Knob, and type Amplitude in the text box. The Knob Properties dialog box should appear similar to Figure 2.24.

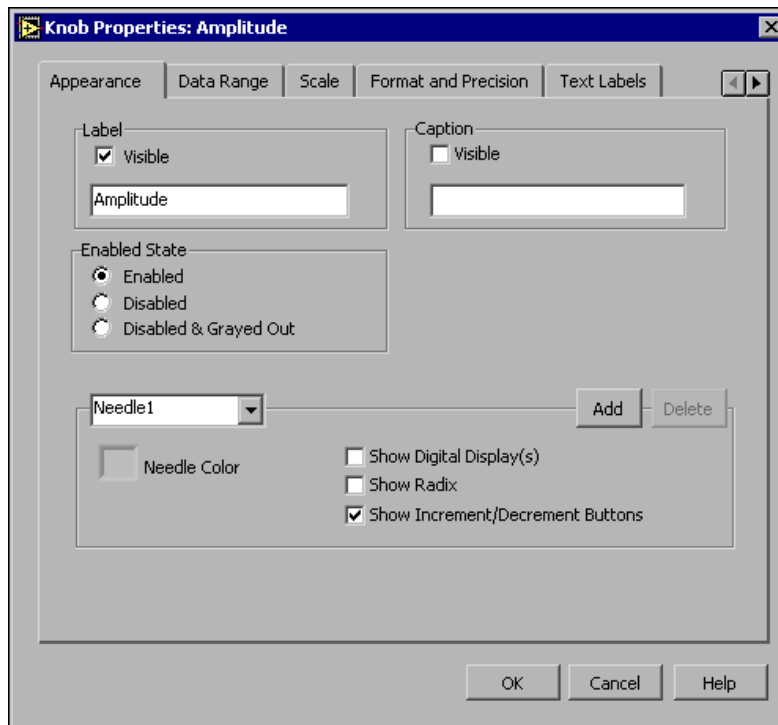

Figure 2.24

3. Click the Scale tab and, in the Scale Range section, change the maximum value to 5.0. Notice how the knob on the front panel instantly updates to reflect these changes.
4. Click the OK button to apply the current configuration and close the Knob Properties dialog box.
5. Save this VI.

TIP: As you build VIs, you can experiment with different properties and configurations. You also can add and delete objects. Remember, you can undo recent edits by selecting `Edit>>Undo` or pressing the `Ctrl-Z` keys.
6. Experiment with other properties of the knob by using the Knob Properties dialog box. For example, try changing the colors for the Marker Text Color by clicking the color box located on the Scale tab.
7. Click the Cancel button to avoid applying the changes you made while experimenting. If you want to keep the changes you made, click the OK button.

2.5.8 Customizing the Waveform Graph

The waveform graph indicator displays the two signals. To indicate which plot is the scaled signal and which is the simulated signal, you customize the plots. Complete the following steps to customize the appearance of an indicator on the front panel.

1. Move the cursor over the top of the plot legend on the waveform graph. Notice that while there are two plots on the graph, the plot legend displays only one plot.

- When a double-headed arrow appears, shown in Figure 2.25, click and drag the border of the plot legend until the second plot name appears.

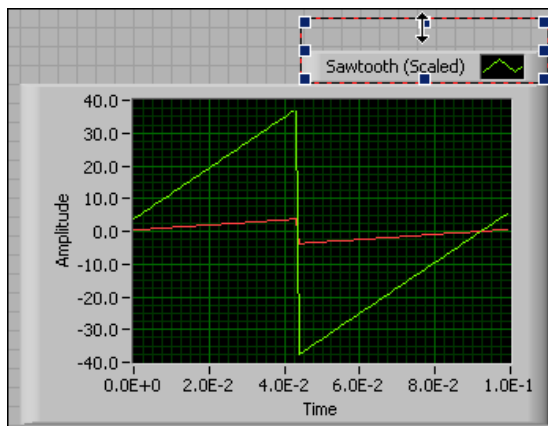

Figure 2.25

- Right-click the waveform graph and select Properties from the shortcut menu to display the Graph Properties dialog box.
- On the Plots tab, select Sawtooth from the pull-down menu. Click the Line Color color box to display the color picker. Select a new line color.
- Select Sawtooth (Scaled) from the pull-down menu.
- Place a checkmark in the Don't use waveform names for plot names checkbox.
- In the Name text box, delete the current label and change the name of this plot to Scaled Sawtooth.
- Click the OK button to apply the current configuration and close the Graph Properties dialog box. Notice how the plot color on the front panel changes.
- Experiment with other properties of the graph by using the Graph Properties dialog box. For example, try disabling the autoscale feature located on the Scales tab.
- Click the Cancel button to avoid applying the changes you made while experimenting. If you want to keep the changes you made, click the OK button.
- Save and close this VI.

2.6 Dataflow Programming

LabVIEW follows a dataflow model for running VIs. A block diagram node executes when all its inputs are available. When a node completes execution, it supplies data to its output terminals and passes the output data to the next node in the dataflow path.

Visual Basic, C++, JAVA, and most other text-based programming languages follow a control flow model of program execution. In control flow, the sequential order of program elements determines the execution order of a program.

Example 2.1:

For a dataflow programming example, consider a block diagram (Figure 2.26) that adds two numbers and then subtracts 50.00 from the result of the addition. In this case, the

block diagram executes from left to right, not because the objects are placed in that order, but because the Subtract function cannot execute until the Add function finishes executing and passes the data to the Subtract function. Remember that a node executes only when data are available at all of its input terminals, and it supplies data to its output terminals only when it finishes execution.

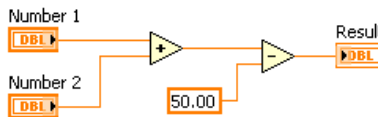

Figure 2.26

Example 2.2:

In the following example (Figure 2.27), consider which code segment would execute first—the Add, Random Number, or Divide function. You cannot know because inputs to the Add and Divide functions are available at the same time, and the Random Number function has no inputs. In a situation where one code segment must execute before another, and no data dependency exists between the functions, use other programming methods, such as error clusters, to force the order of execution. Refer to the Error Handling (Section 6.5) section of Clusters for more information about error clusters.

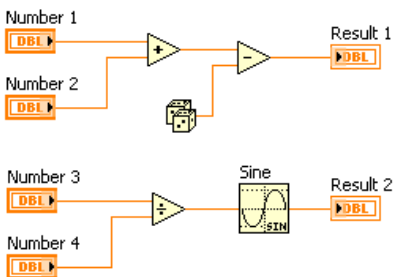

Figure 2.27

2.7 Express Filter VI

Exercise 2.2:

Complete the following steps to use the NI Example Finder to search for an example VI that generates a sine wave with a frequency of 10Hz and an amplitude of 10V with white noise of 1V of amplitude and applies a filter.

1. Select Help » Find Examples to open the NI Example Finder.
2. Click the Search tab and type filter in the Type in the word(s) to search for text box. Notice that this word choice reflects what you want this Express VI to do—filter a signal.

3. Select filter to display the example VIs that include filter in the title.
4. Find the example VI called Express Filter.vi and double-click to open it.
5. Open the block diagram of the VI, shown in Figure 2.28.

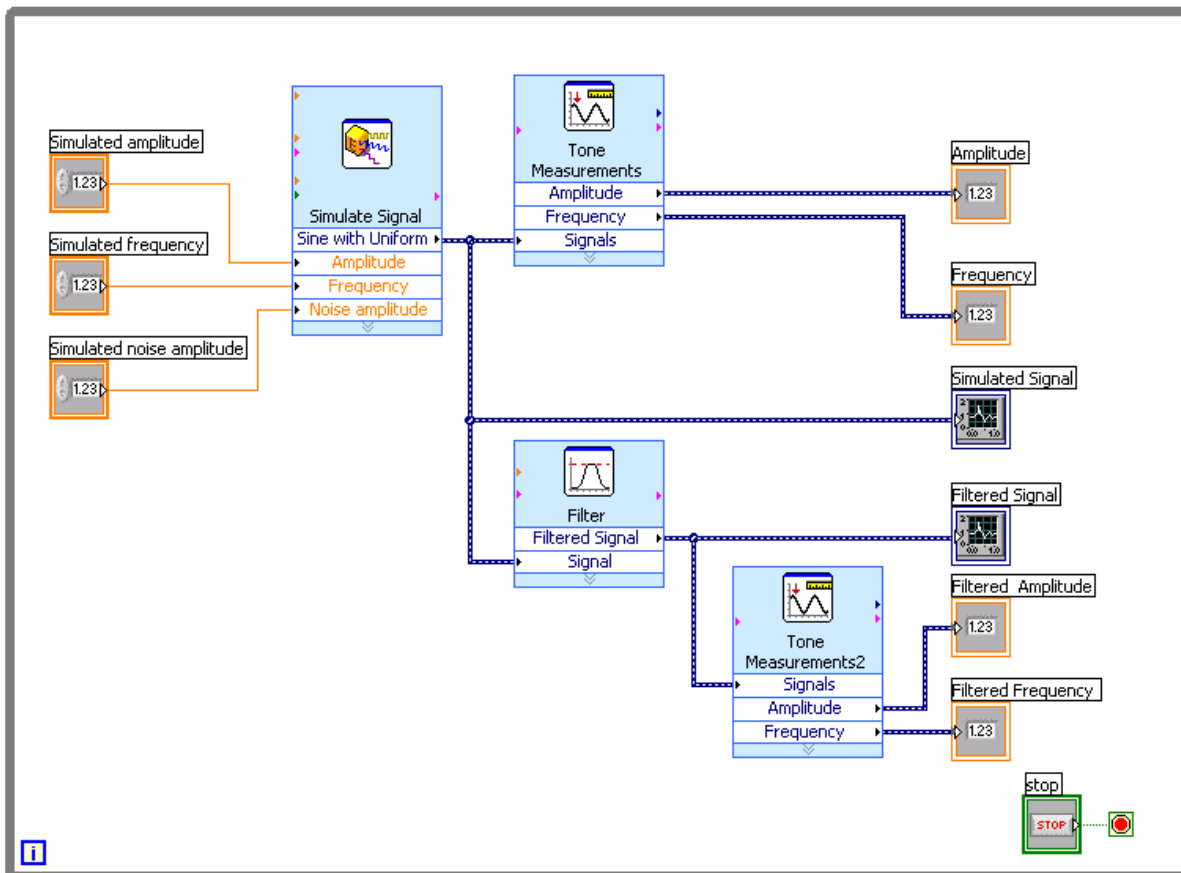

Figure 2.28

6. Click the Highlight Execution button, shown at left, on the toolbar to slow down the execution of the program so you can observe the execution order on the block diagram.
7. Click the Run button
8. Observe the block diagram. Notice the flow of data on the block diagram. For example, notice that the Tone Measurements2 Express VI cannot output data until it receives data from the Filter Express VI.
9. Close the VI when finished. Do not save changes.

2.8 LabVIEW Documentation Resources

2.8.1 LabVIEW Documentation Resources

Use the Context Help window, the *LabVIEW Help*, and the NI Example Finder to help you build and edit VIs. Refer to the *LabVIEW Help* and manuals for more information about LabVIEW.

2.8.1.1 Context Help Window



The Context Help window displays basic information about LabVIEW objects when you move the cursor over each object. The Context Help window is visible by default. To toggle display of the Context Help window, select Help»Show Context Help, press the Ctrl-H keys, or click the Show Context Help Window button, shown in pg 40, on the toolbar.

When you move the cursor over front panel and block diagram objects, the Context Help window displays the icon for subVIs, functions, constants, controls, and indicators, with wires attached to each terminal. When you move the cursor over dialog box options, the Context Help window displays descriptions of those options. In the window, required connections are bold, recommended connections are plain text, and optional connections are dimmed or do not appear. Figure 2.29 shows an example Context Help window.

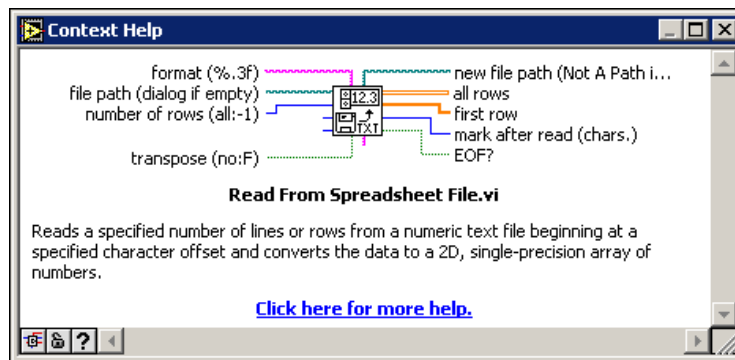

Figure 2.29: Context Help Window



Click the Hide Optional Terminals and Full Path button located on the lower left corner of the Context Help window to display the optional terminals of a connector pane and to display the full path to a VI. Optional terminals are shown by wire stubs, informing you that other connections exist. The detailed mode displays all terminals, as shown in Figure 2.30.

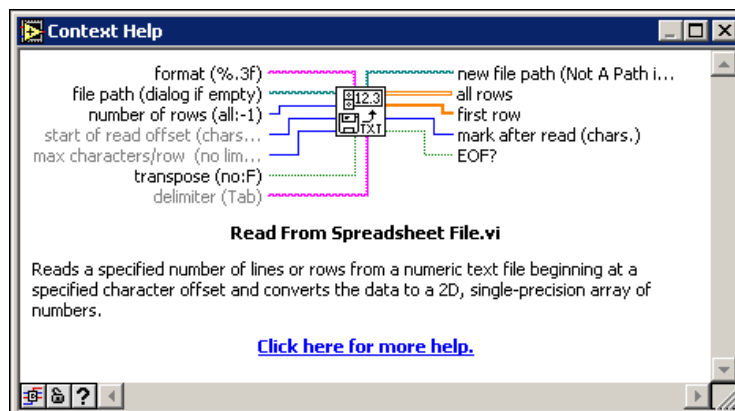

Figure 2.30: Detailed Context Help Window



Click the Lock Context Help button to lock the current contents of the Context Help window. When the contents are locked, moving the cursor over another object does not change the contents of the window. To unlock the window, click the button again. You also can access this option from the Help menu.



If a corresponding *LabVIEW Help* topic exists for an object the Context Help window describes, a blue Click here for more help. link appears in the Context Help window. Also, the More Help button, shown at left, is enabled. Click the link or the button to display the *LabVIEW Help* for more information about the object.

2.8.1.2 LabVIEW Help

You can access the *LabVIEW Help* either by clicking the More Help button in the Context Help window, selecting Help»VI, Function, & How-To Help, or clicking the blue Click here for more help. link in the Context Help window.

The *LabVIEW Help* contains detailed descriptions of most palettes, menus, tools, VIs, and functions. The *LabVIEW Help* also includes step-by-step instructions for using LabVIEW features. The *LabVIEW Help* includes links to the following resources:

- *LabVIEW Bookshelf*, which includes PDF versions of all the LabVIEW manuals and Application Notes.
- Technical support resources on the National Instruments Web site¹, such as the NI Developer Zone², the Knowledge Base³, and the Product Manuals Library⁴.

2.8.1.3 NI Example Finder

The New dialog box contains many LabVIEW template VIs that you can use to start building VIs. However, these template VIs are only a subset of the hundreds of example VIs included with

¹<http://ni.com>

²<http://zone.ni.com/zone/jsp/zone.jsp>

³http://digital.ni.com/public.nsf/MainPage?OpenForm&node=133020_US

⁴http://digital.ni.com/manuals.nsf/MainPage?ReadForm&node=132020_US

LabVIEW. You can modify any example VI to fit an application, or you can copy and paste from an example into a VI that you create.

In addition to the example VIs that ship with LabVIEW, you also can access hundreds of example VIs on the *NI Developer Zone* at ni.com/zone⁵. To search all examples using LabVIEW VIs, use the NI Example Finder. The NI Example Finder is the gateway to all installed examples and the examples located on the *NI Developer Zone*.

To launch the NI Example Finder, select Help>>Find Examples from the front panel or block diagram menu bar. You also can launch the NI Example Finder by clicking the arrow on the Open button on the LabVIEW dialog box and selecting Examples from the shortcut menu.

2.9 Reduce Samples VI

Exercise 2.3:

In the following exercises, you will open a blank VI and add Express VIs and structures to the block diagram to build a new VI. When you complete the exercise, the front panel of the VI will appear similar to the Figure 2.31.

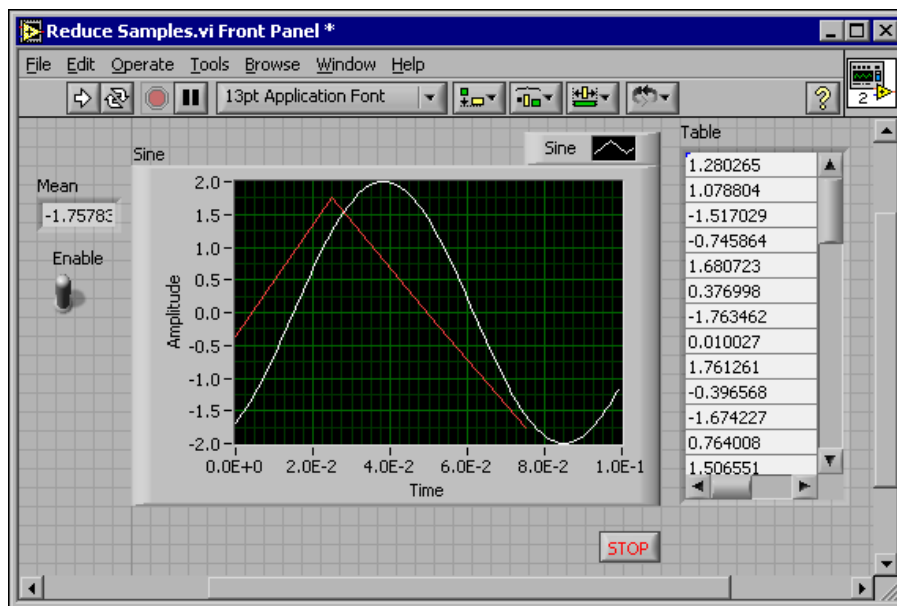

Figure 2.31

2.9.1 Opening a Blank VI

If no template is available for the task you want to create, you can start with a blank VI and add Express VIs to accomplish the specific task. Complete the following steps to open a blank VI.

⁵<http://www.ni.com/zone>

1. In the LabVIEW dialog box, click the arrow on the New button and select Blank VI from the shortcut menu or press the Ctrl-N keys to open a blank VI. Notice that a blank front panel and block diagram appear.



2. If the Functions palette is not visible, right-click any blank space on the block diagram to display the Functions palette. Click the thumbtack, shown in pg 43, in the upper left corner of the Functions palette to place the palette on the screen.

NOTE: You can right-click a blank space on the block diagram or the front panel to display the Functions or Controls palettes.

2.9.2 Adding an Express VI that Simulates a Signal

Complete the following steps to find the Express VI you want to use and then add it to the block diagram.



1. If the Context Help window is not visible, press the Ctrl-H keys to open the Context Help window. You also can press the Show Context Help Window button, shown in pg 43, to open the Context Help window.
2. Select the Input palette on the Functions palette and move the cursor over the Express VIs on the Input palette. Notice that the Context Help window displays information about the function of each Express VI.
3. From the information provided in the Context Help window, find the Express VI that can simulate a sine wave signal.
4. Select the Express VI and place it on the block diagram. The Configure Simulate Signal dialog box appears.
5. Idle the cursor over the various options in the Configure Simulate Signal dialog box, such as Frequency (Hz), Amplitude, and Samples per second (Hz). Read the information that appears in the Context Help window.
6. Configure the Simulate Signal Express VI to generate a sine wave with a frequency of 10.7 and amplitude of 2.
7. Notice how the signal displayed in the Result Preview window changes to reflect the configured sine wave.
8. Close the Configure Simulate Signal dialog box by clicking the OK button.
9. Move the cursor over the Simulate Signal Express VI and read the information that appears in the Context Help window. Notice that the Context Help window now displays the configuration of the Simulate Signal Express VI.
10. Save this VI as Reduce Samples.vi in the C:\Exercises\LabVIEW Basics I directory.

2.9.3 Modifying the Signal

Complete the following steps to use the *LabVIEW Help* to search for the Express VI that reduces the number of samples in a signal.

1. Select Help » VI, Function, & How-To Help to open the *LabVIEW Help*.

2. Click the Search tab and type sample compression in the Type in the word(s) to search for text box. Notice that this word choice reflects what you want this Express VI to do—compress, or reduce, the number of samples in a signal.
3. To begin the search, press the Enter key or click the List Topics button.
4. Double-click the Sample Compression topic to display the topic that describes the Sample Compression Express VI.
5. After you read the description of the Express VI, click the Place on the block diagram button to select the Express VI.
6. Move the cursor to the block diagram. Notice how LabVIEW attaches the Sample Compression Express VI to the cursor.
7. Place the Sample Compression Express VI on the block diagram to the right of the Simulate Signal Express VI.
8. Configure the Sample Compression Express VI to reduce the signal by a factor of 25 using the mean of these values.
9. Close the Configure Sample Compression dialog box.
10. Using the Wiring tool, wire the Sine output in the Simulate Signal Express VI to the Signals input in the Sample Compression Express VI.

2.9.4 Customizing the Front Panel

In a previous exercise (Section 2.5), you added controls and indicators to the front panel using the Controls palette. You also can add controls and indicators from the block diagram. Complete the following steps to create controls and indicators as shown in Figure 2.32.

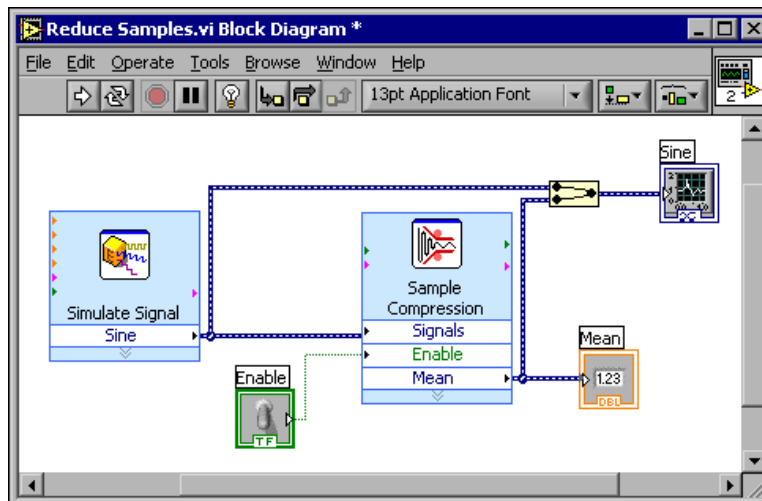

Figure 2.32

1. Right-click the Mean output in the Sample Compression Express VI and select Create>>Numeric Indicator from the shortcut menu to create a numeric indicator.

2. Right-click the Mean output of the Sample Compression Express VI and select Insert Input/Output from the shortcut menu to insert the Enable input.
3. Right-click the Enable input and select Create»Control from the shortcut menu to create the Enable switch.
4. Right-click the wire linking the Sine output in the Simulate Signal Express VI to the Signals input in the Signal Compression Express VI and select Create»Graph Indicator from the shortcut menu. Notice that you can create controls and indicators from the block diagram. When you create controls and indicators using this method, LabVIEW automatically creates terminals that are labeled and formatted correctly.
5. Using the Wiring tool, wire the Mean output in the Sample Compression Express VI to the Sine graph indicator terminal created in the previous step. Notice that the Merge Signals function appears.
6. Arrange the objects on the block diagram so that they appear similar to Figure 2.32.
TIP: You can right-click any wire and select Clean Up Wire from the shortcut menu to automatically route an existing wire.
7. Display the front panel. Notice that the controls and indicators you added automatically appear on the front panel with labels that correspond to their function.
8. Save this VI.

2.9.5 Configuring the VI to Run Continuously Until the User Stops It

In the current state, the VI runs once, generates one signal, then stops executing. To run the VI until a condition is met, you can add a While Loop to the block diagram. Complete the following steps to add a While Loop.

1. Display the front panel and run the VI. Notice how the VI runs once and then stops. Also notice how there is no Stop button.
2. Display the block diagram and select the While Loop on the Functions»Execution Control palette.
3. Move the cursor to the upper left corner of the block diagram. Place the top left corner of the While Loop here.
4. Click and drag the cursor diagonally to enclose *all* the Express VIs and wires, as shown in Figure 2.33.

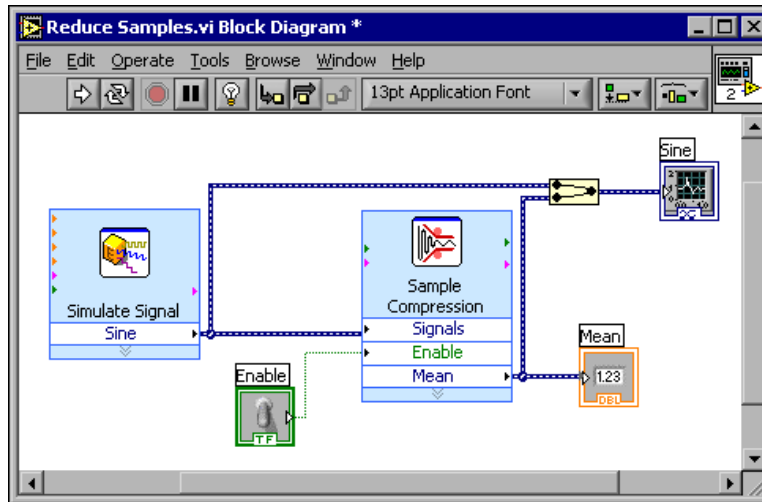
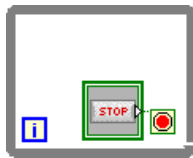

Figure 2.33



Notice that the While Loop, shown in pg 46, appears with a Stop button wired to the condition terminal. This While Loop is configured to stop when the user clicks the Stop button.

5. Display the front panel and run the VI. Notice that the VI now runs until you click the Stop button. A While Loop executes the functions inside the loop until the user presses the Stop button. Refer to Repetition and Loops (Section 4.1) for more information about While Loops.

2.9.6 Controlling the Speed of Execution

To plot the points on the waveform graph more slowly, you can add a time delay to the block diagram. Complete the following steps to control the speed at which the VI executes.

1. On the block diagram, select the Time Delay Express VI on the Functions»»Execution Control palette and place it inside the loop.
2. Type .250 in the Time delay (seconds) text box. This time delay specifies how fast the loop runs. With a .250 second time delay, the loop iterates once every quarter of a second.
3. Close the Configure Time Delay dialog box.
4. Save this VI.
5. Display the front panel and run the VI.
6. Click the Enable switch and notice the change on the graph. Notice how if the Enable switch is on, the graph displays the reduced signal. If the Enable switch is off, the graph does not display the reduced signal.
7. Click the Stop button to stop the VI.

2.9.7 Using a Table to Display Data

Complete the following steps to display a collection of mean values in a table on the front panel.

1. On the front panel, select the Express Table indicator on the Controls>>Text Indicators palette and place it on the front panel to the right of the waveform graph.
2. Display the block diagram. Notice that the Table terminal appears wired to the Build Table Express VI automatically.

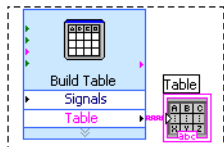

3. If the Build Table Express VI and the Table terminal are not selected already, click an open space on the block diagram to the left of the Build Table Express VI and the Table terminal. Drag the cursor diagonally until the selection rectangle encloses the Build Table Express VI and the Table terminal, shown in pg 47. A moving dashed outline called a marquee highlights the Build Table Express VI, the Table terminal, and the wire joining the two.
4. Drag the objects into the While Loop to the right of the Mean terminal. Notice that the While Loop automatically resizes to enclose the Build Table Express VI and the Table terminal.
5. Using the Wiring tool, wire the Mean terminal of the Sample Compression Express VI to the Signals input of the Build Table Express VI. The block diagram should appear similar to Figure 2.34.

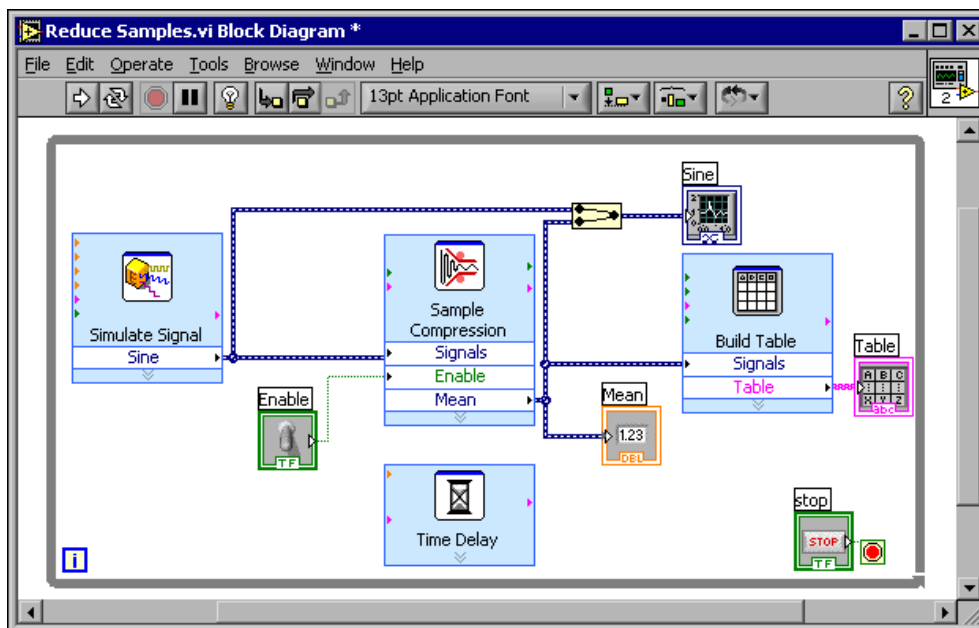

Figure 2.34

6. Display the front panel and run the VI.

7. Click the Enable switch. The table displays the mean values of every 25 samples of the sine wave. Notice if the Enable switch is off, the table does not record the mean values.
8. Stop the VI.
9. Experiment with properties of the table by using the Table Properties dialog box. For example, try changing the number of columns to one.
10. Save and close this VI.

2.10 Debugging Techniques



If a VI does not run, it is a broken, or nonexecutable, VI. The Run button often appears broken, shown at left, when you create or edit a VI. If it is still broken when you finish wiring the block diagram, the VI is broken and will not run. Generally, this means that a required input is not wired, or a wire is broken.

2.10.1 Finding Errors

Click the broken Run button or select **Windows»Show Error List** to display the Error list window, which lists all the errors. Double-click an error description to display the relevant block diagram or front panel and highlight the object that contains the error.

2.10.2 Execution Highlighting



View an animation of the execution of the block diagram by clicking the Highlight Execution button, shown in pg 48. Execution highlighting shows the flow of data on the block diagram from one node to another using bubbles that move along the wires. Use execution highlighting in conjunction with single-stepping to see how data move from node to node through a VI.

NOTE: Execution highlighting greatly reduces the speed at which the VI runs.

2.10.3 Single-Stepping

Single-step through a VI to view each action of the VI on the block diagram as the VI runs. The single-stepping buttons affect execution only in a VI or subVI in single-step mode. Enter single-step mode by clicking the Step Over or Step Into button. Move the cursor over the Step Over, Step Into, or Step Out button to view a tip strip that describes the next step if you click that button. You can single-step through subVIs or run them normally.



If you single-step through a VI with execution highlighting on, an execution glyph, shown in pg 48, appears on the icons of the subVIs that are currently running.

2.10.4 Probes



Use the Probe tool, shown in pg 48, to check intermediate values on a wire as a VFI runs. When execution pauses at a node because of single-stepping or a breakpoint, you also can probe the wire that just executed to see the value that flowed through that wire.

You also can create a custom probe to specify which indicator you use to view the probed data. For example, if you are viewing numeric data, you can choose to see that data in a chart within the probe. To create a custom probe, right-click a wire and select Custom Probe»New from the shortcut menu.

2.10.5 Breakpoints



Use the Breakpoint tool, shown in pg 49, to place a breakpoint on a VI, node, or wire on the block diagram and pause execution at that locatiFon. When you set a breakpoint on a wire, execution pauses after data pass through the wire. Place a breakpoint on the block diagram workspace to pause execution after all nodes on the block diagram execute. When a VI pauses at a breakpoint, LabVIEW brings the block diagram to the front and uses a marquee to highlight the node or wire that contains the breakpoint. LabVIEW highlights breakpoints with red borders for nodes and block diagrams and red bullets for wires. When you move the cursor over an existing breakpoint, the black area of the Breakpoint tool cursor appears white. Use the Breakpoint tool to click an existing breakpoint to remove it.

2.11 Debug Exercise (Main) VI

Exercise 2.4:

Complete the following steps to load a broken VI and correct the error. Use single-stepping and execution highlighting to step through the VI.

2.11.1 Front Panel

1. Select File»Open and navigate to C:\Exercises\LabVIEW Basics I to open the Debug Exercise (Main) VI. The front panel shown in Figure 2.35 appears.

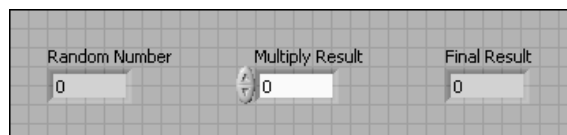

Figure 2.35



Notice the Run button on the toolbar appears broken, shown in pg 49, indicating that the VI is broken and cannot run.

2.11.2 Block Diagram

1. Select Window»Show Block Diagram to display the block diagram shown in Figure 2.36.

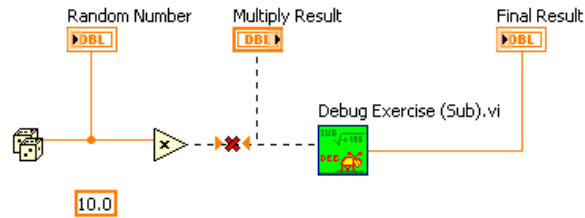

Figure 2.36



The Random Number (0-1) function, located on the Functions»Arithmetic & Comparison»Express Numeric palette, produces a random number between 0 and 1.



The Multiply function, located on the Functions»Arithmetic & Comparison»Express Numeric palette, multiplies the random number by 10.0. The numeric constant, located on the Functions»Arithmetic & Comparison»Express

10.0

Numeric palette, is the number to multiply by the random number. The Debug Exercise (Sub) VI, located in the C:\Exercises\ LabVIEW Basics I directory, adds 100.0 and calculates the square root of the value.



2. Find and fix each error.

- Click the broken Run button to display the Error list window, which lists all the errors.
- Select an error description in the Error list window. The Details section describes the error and in some cases recommends how to correct the error.
- Click the Help button to display a topic in the *LabVIEW Help* that describes the error in detail and includes step-by-step instructions for correcting the error.
- Click the Show Error button or double-click the error description to highlight the area on the block diagram that contains the error.
- Use the Error list window to fix each error.

3. Select File»Save to save the VI.



4. Display the front panel by clicking it or by selecting Window»Show Front Panel.

2.11.3 Run the VI



- Click the Run button to run the VI several times.
- Select Window»Show Block Diagram to display the block diagram.
- Animate the flow of data through the block diagram.



- Click the Highlight Execution button, shown in pg 50, on the toolbar to enable execution highlighting.

- (b)  Click the Step Into button, shown in pg 51, to start single-stepping. Execution highlighting shows the movement of data on the block diagram from one node to another using bubbles that move along the wires. Nodes blink to indicate they are ready to execute.
- (c)  Click the Step Over button, shown in pg 51, after each node to step through the entire block diagram. Each time you click the Step Over button, the current node executes and pauses at the next node. Data appear on the front panel as you step through the VI. The VI generates a random number and multiplies it by 10.0. The subVI adds 100.0 and takes the square root of the result.
- (d)  When a blinking border surrounds the entire block diagram, click the Step Out button, shown in pg 51, to stop single-stepping through the Debug Exercise (Main) VI.

4. Single-step through the VI and its subVI.

- (a) Click the Step Into button to start single-stepping.
- (b)  When the Debug Exercise (Sub) VI blinks, click the Step Into button. Notice the run button on the subVI.
- (c)  Display the Debug Exercise (Main) VI block diagram by clicking it. A green glyph, shown in pg 51, appears on the subVI icon on the Debug Exercise (Main) VI block diagram, indicating that the subVI is running.
- (d) Display the Debug Exercise (Sub) VI block diagram by clicking it.
- (e) Click the Step Out button twice to finish single-stepping through the subVI block diagram. The Debug Exercise (Main) VI block diagram is active.
- (f) Click the Step Out button to stop single-stepping.

5. Use a probe to check intermediate values on a wire as a VI runs.

- (a)  Use the Probe tool, shown pg 51, to click any wire. A window similar to Figure 2.37 appears.

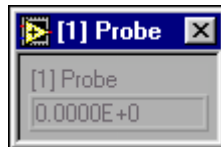



Figure 2.37

LabVIEW numbers the Probe window automatically and displays the same number in a glyph on the wire you clicked.

- (b) Single-step through the VI again. The Probe window displays data passed along the wire.

6. Place breakpoints on the block diagram to pause execution at that location.

- (a)  Use the Breakpoint tool, shown in pg 52, to click nodes or wires. Place a breakpoint on the block diagram to pause execution after all nodes on the block diagram execute.
- (b) Click the Run button to run the VI. When you reach a breakpoint during execution, the VI pauses and the Pause button on the toolbar appears red.
- (c)  Click the Continue button, shown pg 52, to continue running to the next breakpoint or until the VI finishes running.
- (d) Use the Breakpoint tool to click the breakpoints you set and remove them.
7. Click the Highlight Execution button to disable execution highlighting.
8. Select File » Close to close the VI and all open windows.

2.12 Summary, Tips, and Tricks on Introduction to LabVIEW

2.12.1 Summary

- Virtual instruments (VIs) contain three main components—the front panel, the block diagram, and the icon and connector pane.
- The front panel is the user interface of a VI and specifies the inputs and displays the outputs of the VI.
- The block diagram contains the graphical source code composed of nodes, terminals, and wires.
- Use the Tools palette to create, modify, and debug VIs. Press the Shift key and right-click to display a temporary version of the Tools palette at the location of the cursor.
- Use the Controls palette to place controls and indicators on the front panel. Right-click an open space on the front panel to display the Controls palette.
- Use the Functions palette to place VIs and functions on the block diagram. Right-click an open space on the block diagram to display the Functions palette.
- Use the Search button on the Controls and Functions palettes to search for controls, VIs, and functions.
- All LabVIEW objects and empty space on the front panel and block diagram have associated shortcut menus, which you access by right-clicking an object, the front panel, or the block diagram.
- Use the Help menu to display the Context Help window and the *LabVIEW Help*, which describes most palettes, menus, tools, VIs, functions, and features.
- Select Help » Search the LabVIEW Bookshelf to display the *LabVIEW Bookshelf*, which you can use to search PDF versions of all the LabVIEW manuals and *Application Notes*.
- You build the front panel with controls and indicators, which are the interactive input and output terminals of the VI, respectively.
- Control terminals have a thicker border than indicator terminals. To change a control to an indicator or to change an indicator to a control, right-click the object and select Change to Indicator or Change to Control from the shortcut menu.

- The block diagram is composed of nodes, terminals, and wires.
- The broken Run button appears on the toolbar to indicate the VI is broken. Click the broken Run button to display the Error list window, which lists all the errors.
- Use execution highlighting, single-stepping, probes, and breakpoints to debug VIs by animating the flow of data through the block diagram.

2.12.2 Tips and Tricks

2.12.2.1 Operating

- Frequently used menu options have equivalent keyboard shortcuts. For example, to save a VI, you can select File»Save or press the Ctrl-S keys. Common keyboard shortcuts include the following:
 - **Ctrl-R** - Runs a VI.
 - **Ctrl-E** - Toggles between the front panel and block diagram.
 - **Ctrl-H** - Toggles display of the Context Help window.
 - **Ctrl-B** - Removes all broken wires.
 - **Ctrl-F** - Finds VIs, globals, functions, text, or other objects loaded in memory or in a specified list of VIs.
- To increment or decrement numeric controls faster, use the Operating or Labeling tools to place the cursor in the control and press the Shift key while pressing the up or down arrow keys.
- You can disable the debugging tools to reduce memory requirements and to increase performance slightly. Select File»VI Properties, select Execution from the top pull-down menu, and remove the checkmark from the Allow Debugging checkbox.

2.12.2.2 Wiring

- Click the Show Context Help Window button on the toolbar to display the Context Help window. Use the Context Help window to determine which terminals are required. Required terminals are bold, recommended connections are plain text, and optional connections are dimmed.
- Press the spacebar to toggle the wire direction.
- To move objects one pixel, press the arrow keys. To move objects several pixels, press the Shift key while you press the arrow keys.
- To cancel a wire you started, press the Esc key, right-click, or click the terminal where you started the wire.
- Use the tip strips that appear as you move the Wiring tool over terminals.
- Display the connector pane by right-clicking the node and selecting Visible Items»Terminals from the shortcut menu.

- You can bend a wire by clicking to tack the wire down and moving the cursor in a perpendicular direction. To tack down a wire and break it, double-click.

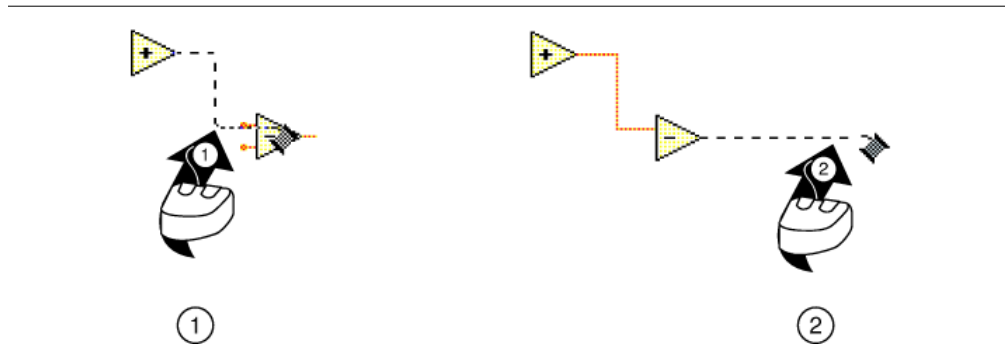

Figure 2.38: 1. Tack Down a Wire by Clicking, 2. Tack and Break the Wire by Double-clicking

2.12.2.3 Editing

- Use the following shortcuts to create constants, controls, and indicators:
 - Right-click a function terminal and select `Create»Constant`, `Create»Control`, or `Create»Indicator` from the shortcut menu.
 - Drag controls and indicators from the front panel to the block diagram to create a constant.
 - Drag constants from the block diagram to the front panel to create a control.
- To duplicate an object, press the `Ctrl` key while using the Positioning tool to click and drag a selection.
- To restrict an object's direction of movement horizontally or vertically, use the Positioning tool to select the object and press the `Shift` key while you move the object.
- To keep an object proportional to its original size as you resize it, press the `Shift` key while you drag the resizing handles or circles.
- To resize an object as you place it on the front panel, press the `Ctrl` key while you click to place the object and drag the resizing handles or circles.
- To replace nodes, right-click the node and select `Replace` from the shortcut menu.
- To display the block diagram of a subVI from the calling VI, press the `Ctrl` key and use the Operating or Positioning tool to double-click the subVI on the block diagram.
- To display the front panel of a subVI from the calling VI, use the Operating or Positioning tool to double-click the subVI on the block diagram. You also can select `Browse»This VI's SubVIs`.
- After you type a label, press the `Enter` key to end text entry.

- To add items quickly to ring controls and Case structures, press the Shift-Enter keys after each item. Pressing Shift-Enter accepts the item and positions the cursor to add the next item. Refer to Making Decisions in a VI (Section 8.2) for more information about Case structures.
- To copy the color of one object and transfer it to a second object without using a color picker, use the Color Copy tool to click the object whose color you want to copy. Use the Coloring tool to click the object to which you want to apply the color. You also can copy the color of one object by using the Coloring tool and pressing the Ctrl key.
- Select Edit»Undo if you make a mistake.
- To create more blank space on the block diagram, press the Ctrl key while you use the Positioning tool to draw a rectangle on the block diagram.

2.12.2.4 Debugging

- When single-stepping, use the following keyboard shortcuts:
 - **Ctrl-down arrow** - Steps into a node.
 - **Ctrl-right arrow** - Steps over a node.
 - **Ctrl-up arrow** - Steps out of a node.

Chapter 3

Modular Programming

3.1 Modular Programming

The power of LabVIEW lies in the hierarchical nature of the VI. After you create a VI, you can use it on the block diagram of another VI. There is no limit on the number of layers in the hierarchy. Using modular programming helps you manage changes and debug the block diagram quickly.

A VI within another VI is called a subVI. A subVI corresponds to a subroutine in text-based programming languages. When you double-click a subVI, a front panel and block diagram appear, rather than a dialog box in which you can configure options. The front panel includes controls and indicators that might look familiar. The block diagram includes wires, front panel icons, functions, possibly subVIs, and other LabVIEW objects that also might look familiar.

The upper right corner of the front panel and block diagram displays the icon for the VI. This icon is the same as the icon that appears when you place the VI on the block diagram.

3.1.1 Icon and Connector Pane



After you build a front panel and block diagram, build the icon and the connector pane so you can use the VI as a subVI. Every VI displays an icon, such as the one shown in pg 57, in the upper right corner of the front panel and block diagram windows. An icon is a graphical representation of a VI. It can contain text, images, or a combination of both. If you use a VI as a subVI, the icon identifies the subVI on the block diagram of the VI. You can double-click the icon to customize or edit it.



You also need to build a connector pane, shown in pg 57, to use the VI as a subVI. The connector pane is a set of terminals that correspond to the controls and indicators of that VI, similar to the parameter list of a function call in text-based programming languages. The connector pane defines the inputs and outputs you can wire to the VI so you can use it as a subVI. A connector pane receives data at its input terminals and passes the data to the block diagram code through the front panel controls and receives the results at its output terminals from the front panel indicators.

As you create VIs, you might find that you perform a certain operation frequently. Consider using subVIs or loops to perform that operation repetitively. For example, the block diagram in Figure 3.1 contains two identical operations.

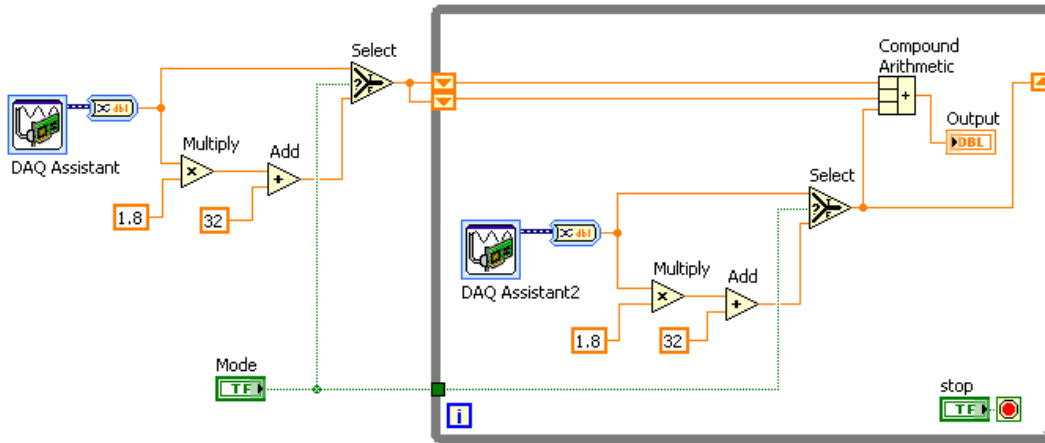

Figure 3.1

You can create a subVI that performs that operation and call the subVI twice. The example in Figure 3.2 calls the Temperature VI as a subVI twice on its block diagram and functions the same as the previous block diagram. You also can reuse the subVI in other VIs. Refer to Repetition and Loops (Section 4.1) for more information about using loops to combine common operations.

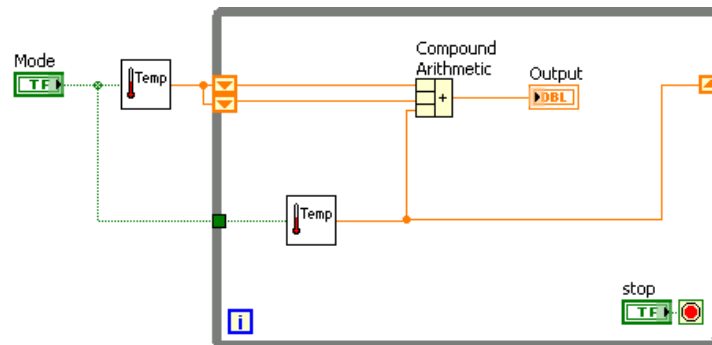

Figure 3.2

Refer to the *LabVIEW Basics II: Development Course Manual* for more information about application development. The following pseudo-code and block diagrams demonstrate the analogy between subVIs and subroutines.

Function Code	Calling Program Code
<pre>main { average (point1, point2, pointavg) }</pre>	<pre>function average (in1, in2, out) { out = (in1 + in2)/2.0; }</pre>
SubVI Block Diagram	CallingVI Block Diagram

3.2 Icons and Connector Panes

After you build a VI front panel and block diagram, build the icon and the connector pane so you can use the VI as a subVI.

3.2.1 Creating an Icon



Every VI displays an icon, shown in pg 59, in the upper right corner of the front panel and block diagram windows. An icon is a graphical representation of a VI. It can contain text, images, or a combination of both. If you use a VI as a subVI, the icon identifies the subVI on the block diagram of the VI.

The default icon contains a number that indicates how many new VIs you have opened since launching LabVIEW. Create custom icons to replace the default icon by right-clicking the icon in the upper right corner of the front panel or block diagram and selecting Edit Icon from the shortcut menu or double-clicking the icon in the upper right corner of the front panel. You also can edit icons by selecting File>>VI Properties selecting General from the Category pull-down menu, and clicking the Edit Icon button.

Use the tools on the left side of the Icon Editor dialog box to create the icon design in the editing area. The normal size image of the icon appears in the appropriate box to the right of the editing area, as shown in the dialog box in Figure 3.3.

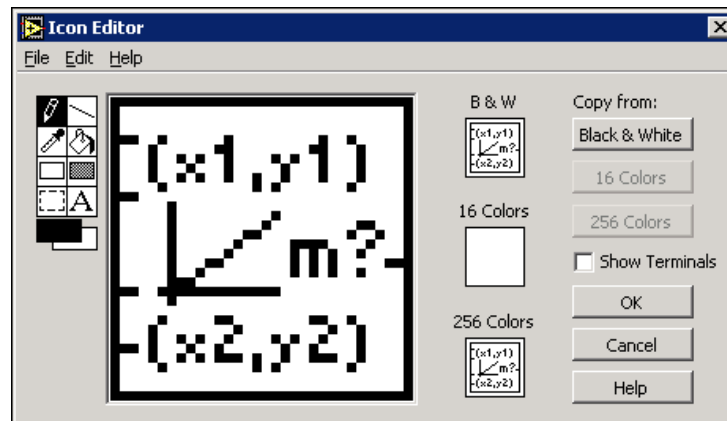

Figure 3.3





Depending on the type of monitor you use, you can design a separate icon for monochrome, 16-color, and 256-color mode. LabVIEW uses the monochrome icon for printing unless you have a color printer.





Use the Edit menu to cut, copy, and paste images from and to the icon. When you select a portion of the icon and paste an image, LabVIEW resizes the image to fit into the selection area. You also can drag a graphic from anywhere in your file system and drop it in the upper right corner of the front panel or block diagram. LabVIEW converts the graphic to a 32×32 pixel icon.

Use the Copy from option on the right side of the Icon Editor dialog box to copy from a color icon to a black-and-white icon and vice versa. After you select a Copy from option, click the OK button to complete the change.

NOTE: If you do not draw a complete border around a VI icon, the icon background appears transparent. When you select the icon on the block diagram, a selection marquee appears around each individual graphic element in the icon.

Use the tools on the left side of the Icon Editor dialog box to create the icon design in the editing area. The normal size image of the icon appears in the appropriate box to the right of the editing area. The following tasks can be performed with these tools:

-  Use the Pencil tool to draw and erase pixel by pixel.
-  Use the Line tool to draw straight lines. To draw horizontal, vertical, and diagonal lines, press the <Shift> key while you use this tool to drag the cursor.
-  Use the Color Copy tool to copy the foreground color from an element in the icon.
-  Use the Fill tool to fill an outlined area with the foreground color.
-  Use the Rectangle tool to draw a rectangular border in the foreground color. Double-click this tool to frame the icon in the foreground color.

-  Use the Filled Rectangle tool to draw a rectangle with a foreground color frame and filled with the background color. Double-click this tool to frame the icon in the foreground color and fill it with the background color.
-  Use the Select tool to select an area of the icon to cut, copy, move, or make other changes. Double-click this tool and press the <Delete> key to delete the entire icon.
-  Use the Text tool to enter text into the icon. Double-click this tool to select a different font. (Windows) The Small Fonts option works well in icons.
-  Use the Foreground/Background tool to display the current foreground and background colors. Click each rectangle to display a color palette from which you can select new colors.
- Use the options on the right side of the editing area to perform the following tasks:
 - **Show Terminals** - Displays the terminal pattern of the connector pane.
 - **OK** - Saves the drawing as the icon and returns to the front panel.
 - **Cancel** - Returns to the front panel without saving any changes.
- The menu bar in the Icon Editor dialog box contains more editing options such as Undo, Redo, Cut, Copy, Paste , and Clear .

3.2.2 Setting Up the Connector Pane



To use a VI as a subVI, you need to build a **connector pane**, shown in pg 61. The connector pane is a set of terminals that corresponds to the controls and indicators of that VI, similar to the parameter list of a function call in text-based programming languages. The connector pane defines the inputs and outputs you can wire to the VI so you can use it as a subVI.

Define connections by assigning a front panel control or indicator to each of the connector pane terminals. To define a connector pane, right-click the icon in the upper right corner of the front panel window and select Show Connector from the shortcut menu. The connector pane replaces the icon. Each rectangle on the connector pane represents a terminal. Use the rectangles to assign inputs and outputs. The number of terminals LabVIEW displays on the connector pane depends on the number of controls and indicators on the front panel. The following front panel has four controls and one indicator, so LabVIEW displays four input terminals and one output terminal on the connector pane.

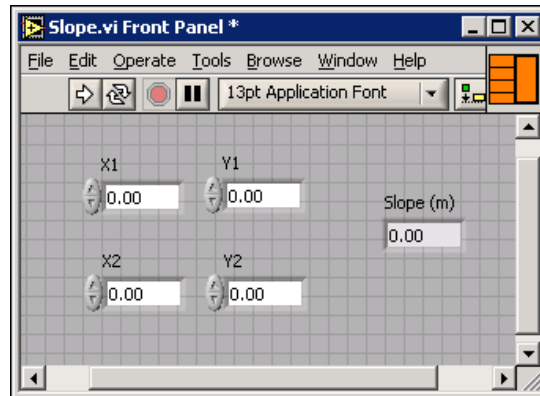

Figure 3.4

3.2.3 Selecting and Modifying Terminal Patterns

Select a different terminal pattern for a VI by right-clicking the connector pane and selecting Patterns from the shortcut menu. Select a connector pane pattern with extra terminals. You can leave the extra terminals unconnected until you need them. This flexibility enables you to make changes with minimal effect on the hierarchy of the VIs. You also can have more front panel controls or indicators than terminals.

A solid border highlights the pattern currently associated with the icon. The maximum number of terminals available for a subVI is 28.



The most commonly used pattern is shown in pg 62. This pattern is used as a standard to assist in simplifying wiring. The top inputs and outputs are commonly used for passing references and the bottom inputs and outputs are used for error handling. Refer to the section on Clusters (Section 6.5) for more information about error handling.

NOTE: Try not to assign more than 16 terminals to a VI. Too many terminals can reduce the readability and usability of the VI.

To change the spatial arrangement of the connector pane patterns, right-click the connector pane and select Flip Horizontal, Flip Vertical, or Rotate 90 Degrees from the shortcut menu.

3.2.4 Assigning Terminals to Controls and Indicators

After you select a pattern to use for the connector pane, you must define connections by assigning a front panel control or indicator to each of the connector pane terminals. When you link controls and indicators to the connector pane, place inputs on the left and outputs on the right to prevent complicated, unclear wiring patterns in your VIs.

To assign a terminal to a front panel control or indicator, click a terminal of the connector pane, then click the front panel control or indicator you want to assign to that terminal. Click an open space on the front panel. The terminal changes to the data type color of the control to indicate that you connected the terminal.

You also can select the control or indicator first and then select the terminal.

NOTE: Although you use the Wiring tool to assign terminals on the connector pane to front panel controls and indicators, no wires are drawn between the connector pane and these controls and indicators.

3.3 Convert C to F VI

Exercise 3.1:

Complete the following steps to create a VI that takes a number representing degrees Celsius and converts it to a number representing degrees Fahrenheit.

3.3.1 Front Panel

1. Open a blank VI and begin building the following front panel.

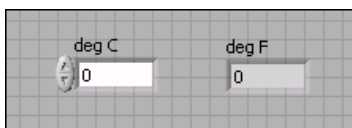

Figure 3.5

2. (Optional) Select Window»Tile Left and Right to display the front panel and block diagram side by side or Window»Tile Up and Down to display the front panel and block diagram stacked.
3. Create a numeric control. You will use this control to enter the value for degrees Celsius.

- (a) Select Controls»Numeric Controls to display the Numeric Controls palette. If the Controls palette is not visible, right-click an open space on the front panel workspace to display it.



- (b) Select the Numeric Control. Move the control to the front panel and click to place the control.



- (c) Type deg C in the label of the control and press the <Enter> key or click the Enter button, shown in pg 63, on the toolbar. If you do not type the name immediately, LabVIEW uses a default label.

NOTE: You can edit a label at any time by double-clicking the label, using the Labeling tool, or right-clicking and selecting Properties from the shortcut menu to display the property dialog box.

4. Create a numeric indicator. You will use this indicator to display the value for degrees Fahrenheit.



- (a) Select the Numeric Indicator located on the Controls»Numeric Indicators palette.





- (b) Move the indicator to the front panel and click to place the indicator.

- (c) Type deg F in the label and press the <Enter> key or click the Enter button.

3.3.2 Block Diagram

1. Display the block diagram by clicking it or by selecting Window» Show Block Diagram. LabVIEW creates corresponding control and indicator terminal icons on the block diagram when you place controls and indicators on the front panel. The terminals represent the data type of the control or indicator. You should see two double-precision, floating-point terminals on the block diagram, one indicator, and one control.

NOTE: Control terminals have a thicker border than indicator terminals.

2.  Place the Multiply function, located on the Functions»Arithmetic & Comparison»Express Numeric palette, on the block diagram to the right of the deg C indicator. If the Functions palette is not visible, right-click an open space on the block diagram workspace to display it.
3.  Place the Add function, located on the Functions»Arithmetic & Comparison»Express Numeric palette, on the block diagram to the right of the Multiply function.
4.  Place a Numeric Constant, located on the Functions»Arithmetic & Comparison»Express Numeric palette, to the lower left of the Multiply function. Type 1.80 in the constant. When you first place a numeric constant, it is highlighted so you can type a value. If the constant is no longer highlighted, double-click the constant to activate the Labeling tool.
5.  Place a Numeric Constant, located on the Functions»Arithmetic & Comparison»Express Numeric palette, to the left of the Add function. Type 32.0 in the constant.
6.  Use the Wiring tool, shown in pg 64, to wire the icons as shown in Figure 3.6.

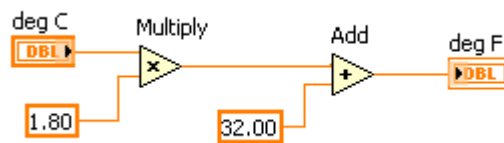

Figure 3.6



- To wire from one terminal to another, use the Wiring tool to click the first terminal, move the tool to the second terminal, and click the second terminal. You can start wiring at either terminal.
- You can bend a wire by clicking to tack down the wire and moving the cursor in a perpendicular direction. Press the spacebar to toggle the wire direction.
- To identify terminals on the nodes, right-click the Multiply and Add functions and select Visible Items»Terminals from the shortcut menu to display the connector pane on the block diagram. Return to the icons after wiring by right-clicking the functions and selecting Visible Items»Terminals from the shortcut menu to remove the checkmark.

- When you move the Wiring tool over a terminal, the terminal area blinks, indicating that clicking will connect the wire to that terminal and a tip strip appears, displaying the name of the terminal. If the Context Help window is open, the terminal area also blinks in the Context Help window.
- To cancel a wire you started, press the <Esc> key, right-click, or click the terminal where you started the wire.

7. Display the front panel by clicking it or by selecting Window»Show Front Panel.
8. Save the VI as Convert C to F.vi in the C:\Exercises\LabVIEW Basics I directory.



3.3.3 Run the VI

1. Enter a number in the numeric control and run the VI.

- (a)  Use the Operating tool, shown in pg 65, or the Labeling tool to double-click the numeric control and type a new number.
- (b)  Click the Run button, shown at left, to run the VI.
- (c) Try several different numbers and run the VI again.

3.3.4 Icon and Connector Pane

1. Right-click the icon in the upper right corner of the front panel window and select Edit Icon from the shortcut menu. The Icon Editor dialog box appears.

2.  Double-click the Select tool, shown in pg 65, on the left side of the Icon Editor dialog box to select the default icon.
3. Press the <Delete> key to remove the default icon.
4.  Double-click the Rectangle tool, shown in pg 65, to redraw the border.
5. Create the icon in Figure 3.7.

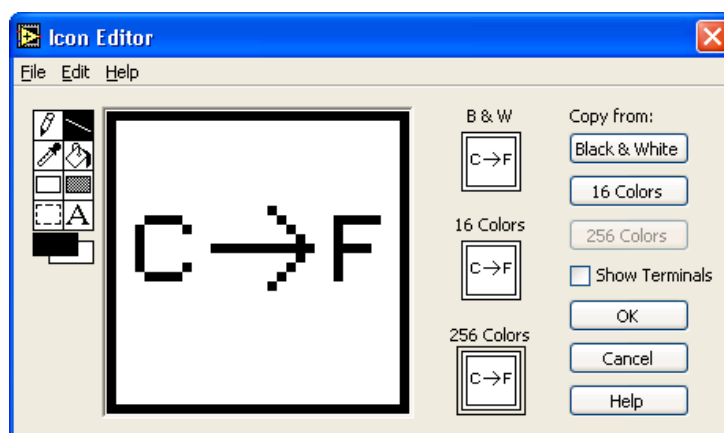





Figure 3.7

- (a)  Double-click the Text tool, shown in pg 66, and change the font to Small Fonts .
- (b) Use the Text tool to click the editing area where you will begin typing.
- (c) Type C and F. While the text is active, you can move the text by pressing the arrow keys.

- (d)  Use the Pencil tool, shown in pg 66, to create the arrow.
- NOTE: To draw horizontal or vertical straight lines, press the <Shift> key while you use the Pencil tool to drag the cursor.
- (e) Use the Select tool and the arrow keys to move the text and arrow you created.
- (f) Select the B & W icon and click the 256 Colors button in the Copy from section to create a black and white icon, which LabVIEW uses for printing unless you have a color printer.
- (g) Select the 16 Colors icon and click the 256 Colors button in the Copy from section.
- (h) When you complete the icon, click the OK button to close the Icon Editor dialog box. The icon appears in the upper right corner of the front panel and block diagram.

6.  Right-click the icon on the front panel and select Show Connector from the shortcut menu to define the connector pane terminal pattern. LabVIEW selects a default connector pane pattern based on the number of controls and indicators on the front panel. For example, this front panel has two terminals, deg C and deg F , so LabVIEW selects a connector pane pattern with two terminals, shown in pg 66.

7. Assign the terminals to the numeric control and numeric indicator.
- (a) Select Help»Show Context Help to display the Context Help window.
- (b) Click the left terminal in the connector pane. The tool automatically changes to the Wiring tool, and the terminal turns black.
- (c) Click the deg C control. A marquee highlights the control on the front panel.
- (d) Click an open space on the front panel. The marquee disappears, and the terminal changes to the data type color of the control to indicate that you connected the terminal.
- (e) Click the right terminal in the connector pane, and click the deg F indicator.
- (f) Click an open space on the front panel. Both terminals of the connector pane are orange.
- (g) Move the cursor over the connector pane. The Context Help window shows that both terminals are connected to double-precision, floating-point values.

8. Save and close the VI. You will use this VI later in the course.

3.4 Using SubVIs

After you build a VI and create its icon and connector pane, you can use the VI as a subVI. To place a subVI on the block diagram, select Functions»All Functions»Select a VI . Navigate to the VI you want to use as a subVI and double-click to place it on the block diagram.

You also can place an open VI on the block diagram of another open VI. Use the Positioning tool to click the icon in the upper right corner of the front panel or block diagram of the VI you want to use as a subVI and drag the icon to the block diagram of the other VI.

3.4.1 Opening and Editing SubVIs

To display the front panel of a subVI from the calling VI, use the Operating or Positioning tool to double-click the subVI on the block diagram. You also can select **Browse»This VI's SubVIs**. To display the block diagram of a subVI from the calling VI, press the <Ctrl> key and use the Operating or Positioning tool to double-click the subVI on the block diagram.

Any changes you make to a subVI affect only the current instance of the subVI until you save the subVI. When you save the subVI, the changes affect all calls to the subVI, not just the current instance.

3.4.2 Setting Required, Recommended, and Optional Inputs and Outputs

In the Context Help window, which you can access by selecting **Help»Show Context Help** required terminals appear bold, recommended terminals appear as plain text, and optional terminals appear dimmed. The labels of optional terminals do not appear if you click the **Hide Optional Terminals** and **Full Path** button in the Context Help window.

You can designate which inputs and outputs are required, recommended, and optional to prevent users from forgetting to wire subVI terminals.

Right-click a terminal in the connector pane and select **This Connection Is** from the shortcut menu. A checkmark indicates the terminal setting. Select **Required**, **Recommended**, or **Optional**.

For terminal inputs, required means that the block diagram on which you placed the subVI will be broken if you do not wire the required inputs. Required is not available for terminal outputs. For terminal inputs and outputs, recommended or optional means that the block diagram on which you placed the subVI can execute if you do not wire the recommended or optional terminals. If you do not wire the terminals, the VI does not generate any warnings.

LabVIEW sets inputs and outputs of VIs you create to Recommended by default. Set a terminal setting to required only if the VI must have the input or output to run properly. Refer to the **Read File** function located on the **Functions»All Functions»File I/O** palette for examples of required, recommended, and optional inputs and outputs.

3.5 Thermometer VI

Exercise 3.2:

Complete the following steps to create a VI that reads a measurement from the temperature sensor on the DAQ Signal Accessory and displays the temperature in Celsius or Fahrenheit.

The sensor returns a voltage proportional to temperature. For example, if the temperature is 23°, the sensor output voltage is 0.23 V. The sensor is connected to Channel 0 of Device 1. Device 1 is the DAQ device. On some systems, the DAQ device may have another device number.

3.5.1 Front Panel

1. In the LabVIEW dialog box, click the arrow on the **New** button and select **Blank VI** from the shortcut menu or press the <Ctrl-N> keys to open a blank VI.
2. Create the following front panel.

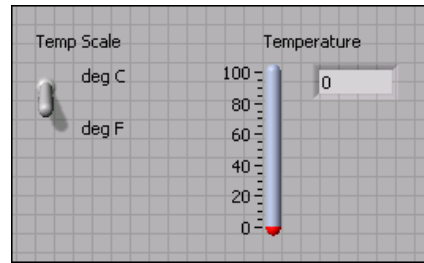



Figure 3.8

- (a) Place a thermometer, located on the Controls»Numeric Indicators palette, on the front panel.
- (b)  Type Temperature in the label and press the <Enter> key or click the Enter button on the toolbar, shown at left.
- (c) Right-click the thermometer and select Visible Items» Digital Display from the shortcut menu to show the digital display for the thermometer.
- (d) Place a vertical toggle switch control, located on the Controls»Buttons & Switches palette, on the front panel.
- (e) Type Temp Scale in the label and press the <Enter> key or click the Enter button.
- (f)  Use the Labeling tool, shown in pg 68, to place a free label, deg C, next to the True position of the switch. If you are using automatic tool selection, double-click the blank area of the front panel to begin typing a free label.
- (g) Place a free label, deg F , next to the False position of the switch.

3.5.2 User Documentation

1. Document the VI so a description appears in the Context Help window when you move the cursor over the VI icon.
 - (a) Select File»VI Properties to display the VI Properties dialog box.
 - (b) Select Documentation from the Category pull-down menu.
 - (c) Type the following description for the VI in the VI description text box: This VI measures temperature using the temperature sensor on the DAQ Signal Accessory.
 - (d) Click the OK button.
2. Document the thermometer indicator and switch control so descriptions appear in the Context Help window when you move the cursor over the objects and tip strips appear on the front panel or block diagram when you move the cursor over the objects while the VI runs.
 - Right-click the thermometer indicator and select Description and Tip from the shortcut menu.
 - Type the following description for the thermometer in the Description text box: Displays the temperature measurement.
 - Type temperature in the Tip text box.
 - Click the OK button.

- Right-click the switch control and select Description and Tip from the shortcut menu.
 - Type the following description for the vertical switch control in the Description text box: Determines the scale (Fahrenheit or Celsius) to use for the temperature measurement.
 - Type scale - C or F in the Tip text box.
 - Click the OK button.
3. Select Help»Show Context Help to display the Context Help window.
 4. Move the cursor over the front panel objects and the VI icon to display the descriptions in the Context Help window.

3.5.3 Block Diagram

1. Select Window»Show Block Diagram to display the block diagram (Figure 3.9).

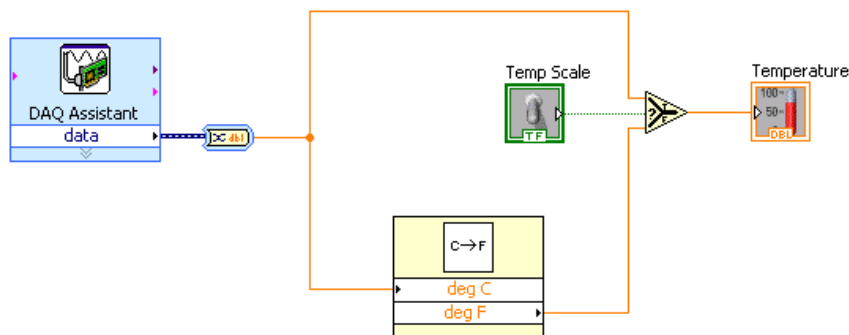

Figure 3.9



2. Place the DAQ Assistant Express VI, located on the Functions»Input palette, on the block diagram. When you place this Express VI on the block diagram the DAQ Assistant configuration dialog box appears.
 - (a) Select Analog Input»Voltage for the type of measurement to make.
 - (b) Select Dev1»ai0 (or Dev2»ai0) for the physical channel and click the Finish button.
 - (c) You must multiply the temperature by 100 to convert it from voltage to Celsius. On the Settings tab, select Custom Scaling»Create New. Select a Linear scale. Name the scale Temperature. Enter a slope scale of 100. Click the OK button.
 - (d) Set min = 0. Set max = 100
 - (e) Select the Acquire 1 Sample option on the Task Timing tab. Click the OK button.

NOTE: If you do not have a DAQ device with a temperature sensor connected to your computer, use the (Demo) Read Voltage VI, located in the C:\Exercises LabVIEW Basics I directory.



3. Place the Convert from Dynamic Data Express VI, located on the Functions»Signal Manipulation palette, on the block diagram. This VI converts

the dynamic data type. In the configuration dialog box, select Single scalar in the Resulting data type listbox.



- Place the Convert C to F VI on the block diagram. Select Functions»All Functions»Select a VI, navigate to C:\Exercises\LabVIEW Basics I\Convert C to F.vi. This VI converts the Celsius readings to Fahrenheit.



- Place the Select function, located on the Functions»Arithmetic & Comparison»Express Comparison palette, on the block diagram. This function returns either the Fahrenheit (False) or Celsius (True) temperature value, depending on the value of Temp Scale. Use the Positioning tool to place the icons as shown in the block diagram (Figure 3.9) and use the Wiring tool to wire them together.

NOTE: To display terminals for a node, right-click the icon and select Visible Items»Terminals from the shortcut menu.

3.5.4 Front Panel

- Display the front panel by clicking it or by selecting Window»Show Front Panel .



- Click the Run Continuously button, shown at left, to run the VI continuously.
- Put your finger on the temperature sensor and notice the temperature increase.
- Click the Run Continuously button again to stop the VI. This allows the VI to finish the current run of the VI.

3.5.5 Icon and Connector Pane

- Create an icon so you can use the Thermometer VI as a subVI. The following icon is an example. If necessary, create a simpler icon to save time.

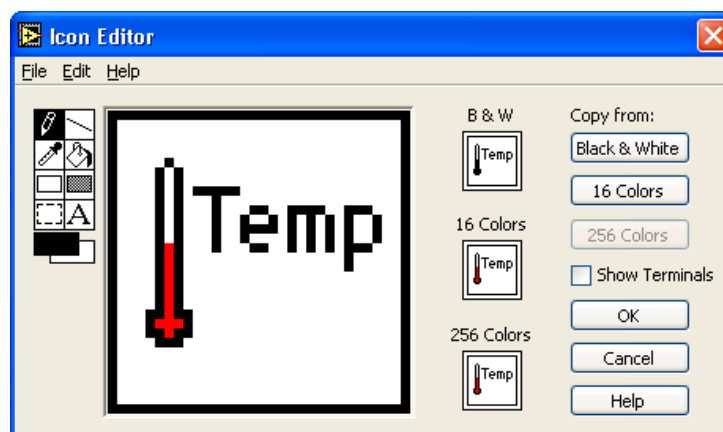





Figure 3.10

- (a) Right-click the icon in the upper right corner of the front panel and select Edit Icon from the shortcut menu. The Icon Editor dialog box appears.

- (b)  Double-click the Select tool, shown at left, on the left side of the Icon Editor dialog box to select the default icon.

- (c) Press the <Delete> key to remove the default icon.

- (d)  Double-click the Rectangle tool, shown at pg 71, to redraw the border.

- (e)  Use the Pencil tool, shown in pg 71, to draw an icon that represents the thermometer.

- (f) Use the Foreground and Fill tools to color the thermometer red.

NOTE: To draw horizontal or vertical straight lines, press the <Shift> key while you use the Pencil tool to drag the cursor.

- (g)  Double-click the Text tool, shown in pg 71, and change the font to Small Fonts.

- (h) Type Temp. Reposition the text if necessary.

- (i) Select the B & W icon and select 256 Colors in the Copy from section to create a black and white icon, which LabVIEW uses for printing unless you have a color printer.

- (j) When the icon is complete, click the OK button. The icon appears in the upper right corner of the front panel.

2. Right-click the icon and select Show Connector from the shortcut menu and assign terminals to the switch and the thermometer.

- (a) Click the left terminal in the connector pane.

- (b) Click the Temp Scale control. The left terminal turns green.

- (c) Click the right terminal in the connector pane.

- (d) Click the Temperature indicator. The right terminal turns orange.

- (e) Click an open space on the front panel.

3. Save the VI as Thermometer.vi in the C:\Exercises\ LabVIEW Basics I directory. You will use this VI later in the course.

4. Close the VI.

3.6 Creating a SubVI from Sections of a VI

You can simplify the block diagram of a VI by converting sections of the block diagram into subVIs. Convert a section of a VI into a subVI by using the Positioning tool to select the section of the block diagram you want to reuse and selecting Edit>>Create SubVI. An icon for the new subVI replaces the selected section of the block diagram. LabVIEW creates controls and indicators for the new subVI and wires the subVI to the existing wires. Figure 3.11 shows how to convert a selection into a subVI.

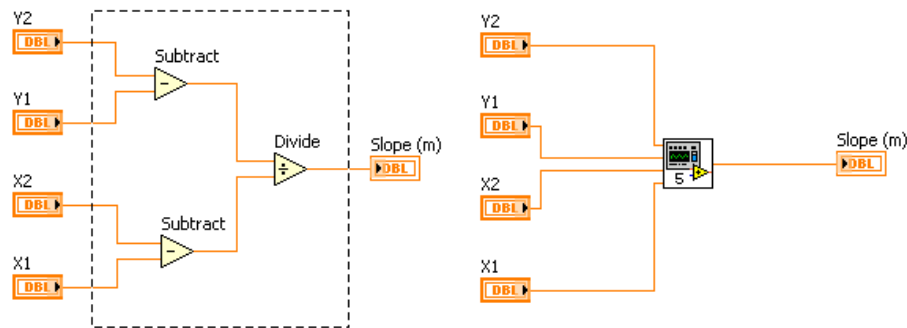

Figure 3.11

The new subVI uses a default pattern for the connector pane and a default icon. Double-click the subVI to edit the connector pane and icon, and to save the subVI.

NOTE: Do not select more than 28 objects to create a subVI because 28 is the maximum number of connections on a connector pane.

3.7 Summary, Tips, and Tricks on Modular Programming

- A VI within another VI is called a subVI. Using subVIs helps you manage changes and debug the block diagram quickly.
- After you build a VI front panel and block diagram, build the icon and the connector pane so you can use the VI as a subVI.
- The connector pane is a set of terminals that corresponds to the controls and indicators of that VI. Define connections by assigning a front panel control or indicator to each of the connector pane terminals.
- Create custom icons to replace the default icon by double-clicking the icon in the upper right corner of the front panel to open the Icon Editor.
- In the Icon Editor dialog box, double-click the Text tool to select a different font.
- You can designate which inputs and outputs are required, recommended, and optional to prevent users from forgetting to wire subVI connections. Right-click a terminal in the connector pane and select This Connection Is from the shortcut menu.
- Document a VI by selecting File»VI Properties and selecting Documentation from the Category pull-down menu. When you move the cursor over a VI icon, the Context Help window displays this description and indicates which terminals are required, recommended, or optional.
- Add descriptions and tip strips to controls and indicators by right-clicking them and selecting Description and Tip from the shortcut menu. When you move the cursor over controls and indicators, the Context Help window displays this description.
- Convert a section of a VI into a subVI by using the Positioning tool to select the section of the block diagram you want to reuse and selecting Edit»Create SubVI.

Chapter 4

Repetition and Loops

4.1 While Loops

A While Loop executes a subdiagram until a condition is met. The While Loop is similar to a Do Loop or a Repeat-Until Loop in text-based programming. Figure 4.1 shows a While Loop in LabVIEW, a flow chart equivalent of the While Loop functionality, and a pseudo code example of the functionality of the While Loop.

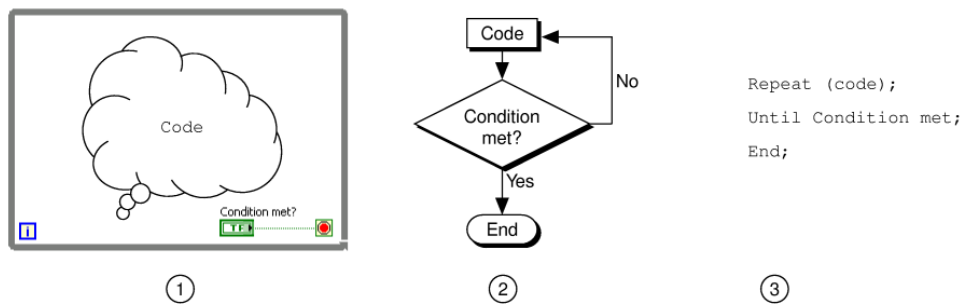



Figure 4.1

The While Loop is located on the Functions»Execution Control palette. Select the While Loop from the palette then use the cursor to drag a selection rectangle around the section of the block diagram you want to repeat. When you release the mouse button, a While Loop boundary encloses the section you selected.

Add block diagram objects to the While Loop by dragging and dropping them inside the While Loop.

NOTE: The While Loop always executes at least once.

 The While Loop executes the subdiagram until the conditional terminal, an input terminal, receives a specific Boolean value. The default behavior and appearance of the conditional terminal is Stop If True, shown in pg 73. When a conditional terminal is Stop If True, the While Loop executes its subdiagram until the conditional terminal receives a True value.

 The iteration terminal, an output terminal, shown in pg 73, contains the number of completed

iterations. The iteration count always starts at zero. During the first iteration, the iteration terminal returns 0.

In the block diagram in Figure 4.2, the While Loop executes until the subVI output is greater than or equal to 10.00 and the Enable control is True. The And function returns True only if both inputs are True. Otherwise, it returns False.

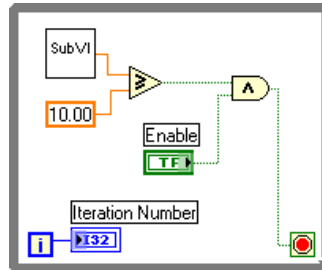



Figure 4.2

In the previous example (Figure 4.2), there is an increased probability of an infinite loop. Generally, the desired behavior is to have one condition met to stop the loop, rather than requiring both conditions to be met.

 You can change the behavior and appearance of the conditional terminal by right-clicking the terminal or the border of the While Loop and selecting Continue if True, shown at left. You also can use the Operating tool to click the conditional terminal to change the condition. When a conditional terminal is Continue if True, the While Loop executes its subdiagram until the conditional terminal receives a False value, as shown in Figure 4.3.

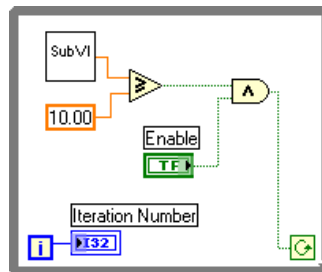

Figure 4.3

The While Loop executes until the subVI output is less than 10.00 or the Enable control is False.

4.1.1 Structure Tunnels

Data can be passed out of or into a While Loop through a tunnel. Tunnels feed data into and out of structures. The tunnel appears as a solid block on the border of the While Loop. The block is the color of the data type wired to the tunnel. Data pass out of a loop after the loop terminates. When a tunnel passes data into a loop, the loop executes only after data arrive at the tunnel.

In Figure 4.4, the iteration terminal is connected to a tunnel. The value in the tunnel does not get passed to the Iteration Number indicator until the While Loop has finished execution.

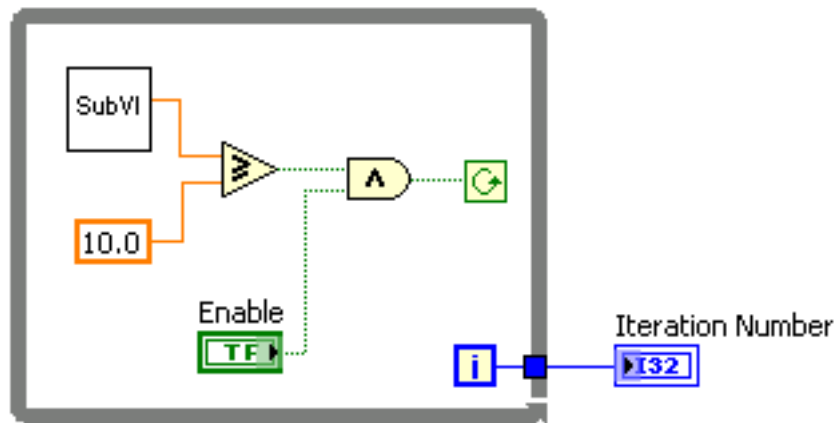

Figure 4.4

Only the last value of the iteration terminal displays in the Iteration Number indicator.

4.2 Auto Match VI

Exercise 4.1:

Complete the following steps to build a VI that generates random numbers until the number generated matches a number you specify. The iteration terminal records the number of random numbers generated until a match occurs.

4.2.1 Front Panel

1. Open a blank VI and build the front panel shown in Figure 4.5. Modify the controls and indicators as shown in the front panel (Figure 4.5) and as described in the following steps (pg 76).

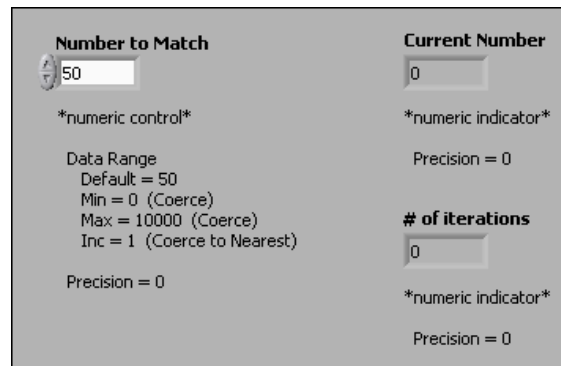

Figure 4.5

- (a) Place a numeric control, located on the Controls»»Numeric Controls palette, on the front panel. Label the control Number to Match. This control specifies the number to match.
- (b) Place a numeric indicator, located on the Controls»»Numeric Indicators palette, on the front panel. Label the indicator Current Number. This indicator displays the current random number.
- (c) Place another numeric indicator on the front panel. Label the indicator Number of iterations. This indicator displays the number of iterations before a match.

4.2.2 Setting the Data Range

Set a data range for a control to prevent the user from selecting a value that is not compatible with a range or increment. You can choose to ignore a value that is out of range or coerce it to within the range. Complete the following steps (pg 76) to set the range between 0 and 10000 with an increment of 1 and a default value of 50.

1. Right-click the Number to Match control and select Data Range from the shortcut menu. The Data Range page of the Numeric Properties dialog box appears.
 - (a) Remove the checkmark from the Use Default Range checkbox.
 - (b) Set the Default Value to 50.
 - (c) Set the Minimum value to 0 and select Coerce from the Out of Range Action pull-down menu.
 - (d) Set the Maximum value to 10000 and select Coerce from the Out of Range Action pull-down menu.
 - (e) Set the Increment value to 1 and select Coerce to Nearest from the Out of Range Action pull-down menu. Do not close the dialog box.

4.2.3 Modifying Digits of Precision

By default, LabVIEW automatically formats numeric controls. You also can specify the precision or notation. You can display numeric values in floating-point, scientific, or SI notation. Complete the following steps to change the precision to 0.

1. Select the Format and Precision tab. If you closed the Numeric Properties dialog box, right-click the Current Number indicator and select Format & Precision from the shortcut menu. The Format & Precision page of the Numeric Properties dialog box appears.
 - (a) Select Floating Point and change Significant digits to Digits of precision.
 - (b) Type 0 in the Digits of precision text box and click the OK button.
2. Repeat the instructions to set the precision for Current Number and Number of iterations indicators.

4.2.4 Block Diagram

1. Build the block diagram in Figure 4.6.

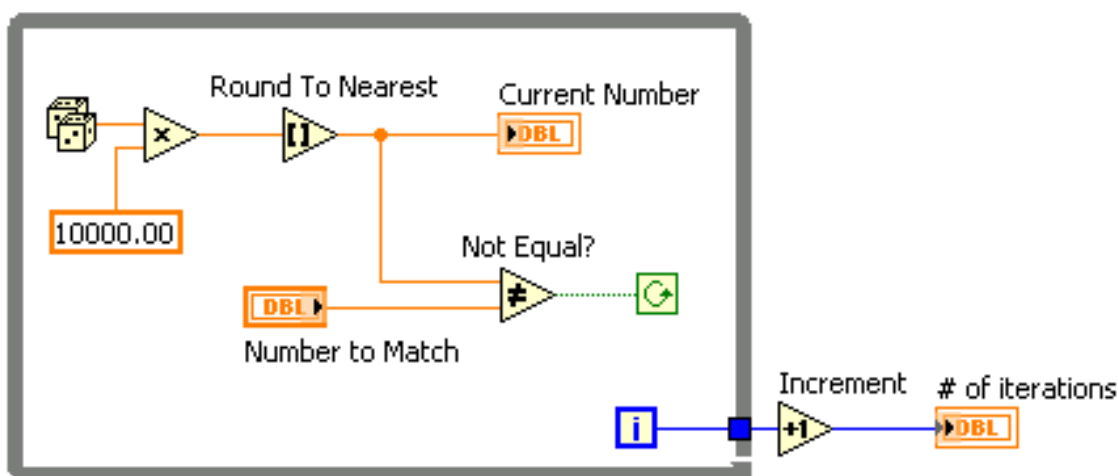









Figure 4.6

- (a)  Place the Random Number (0-1) function, located on the Functions»Arithmetic & Comparison»Express Numeric palette, on the block diagram. This function produces a random number between 0 and 1.
- (b)  Place the Multiply function, located on the Functions»Arithmetic & Comparison»Express Numeric palette, on the block diagram. This function multiplies the random number by 10,000 to produce a random number between 0 and 10,000.
- (c)  Right-click the y terminal of the Multiply function, select Create»Constant from the shortcut menu, type 10000, and press the <Enter> key to create a numeric constant.
- (d)  Place the Round To Nearest function, located on the Functions»Arithmetic & Comparison»Express Numeric palette, on the block diagram. This function rounds the random number to the nearest integer.

- (e)  Place the Not Equal? function, located on the Functions»Arithmetic & Comparison»Express Comparison palette, on the block diagram. This function compares the random number with Number to Match and returns True if the numbers are not equal; otherwise, it returns False.

- (f)  Place the While Loop, located on the Functions»All Functions»Structures palette, on the block diagram. Right-click the conditional terminal and select Continue if True from the shortcut menu.

NOTE: Use the While Loop with Stop button, located on the Execution Control palette, when you need a stop button to stop the While Loop. In this exercise, you use the Number to Match control to stop the loop; you do not need a Stop button.

- (g)  Wire the iteration terminal to the border of the While Loop. A blue tunnel appears on the While Loop border. You will wire the tunnel to the Increment function. Each time the loop executes, the iteration terminal increments by one. The iteration count passes out of the loop upon completion. Increment this value by one outside the loop because the count starts at 0.

- (h)  Place the Increment function, located on the Functions»Arithmetic & Comparison»Express Numeric palette, on the block diagram. This function adds 1 to the While Loop count. A coercion dot appears on the Number of iterations output to indicate that LabVIEW coerced the numeric representation of the iteration terminal to match the numeric representation of the Number of iterations output. Refer to the For Loops (Section 4.3) section for more information about numeric conversion.

2. Save the VI as Auto Match.vi.

4.2.5 Run the VI

1. Display the front panel and change the number in Number to Match.
2. Run the VI. Change Number to Match and run the VI again. Current Number updates at every iteration of the loop because it is inside the loop. Number of iterations updates upon completion because it is outside the loop.

3.  To see how the VI updates the indicators, enable execution highlighting. On the block diagram toolbar, click the Highlight Execution button, shown at left, to enable execution highlighting. Execution highlighting shows the movement of data on the block diagram from one node to another so you can see each number as the VI generates it.

4. Change Number to Match to a number that is out of the data range, which is 0 to 10000 with an increment of 1.

5. Run the VI. LabVIEW coerces the out-of-range value to the nearest value in the specified data range.

6. Close the VI.

4.3 For Loops

A For Loop executes a subdiagram a set number of times. Figure 4.7 shows a For Loop in LabVIEW, a flow chart equivalent of the For Loop functionality, and a pseudo code example of the functionality of the For Loop.

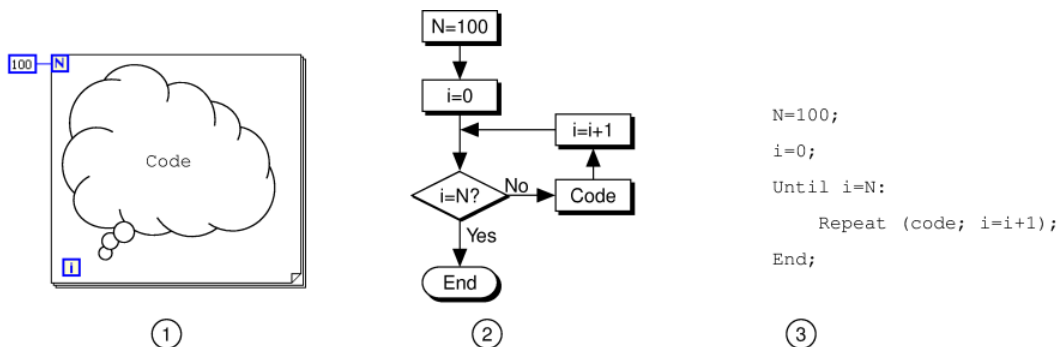

Figure 4.7

N The For Loop is located on the Functions»All Functions»Structures palette. You also can place a While Loop on the block diagram, right-click the border of the While Loop, and select Replace with For Loop from the shortcut menu to change a While Loop to a For Loop. The value in the count terminal (an input terminal), shown in pg 79, indicates how many times to repeat the subdiagram.

i The iteration terminal (an output terminal), shown in pg 79, contains the number of completed iterations. The iteration count always starts at zero. During the first iteration, the iteration terminal returns 0.

The For Loop differs from the While Loop in that the For Loop executes a set number of times. A While Loop stops executing the subdiagram only if the value at the conditional terminal exists.

The For Loop in Figure 4.8 generates a random number every second for 100 seconds and displays the random numbers in a numeric indicator.

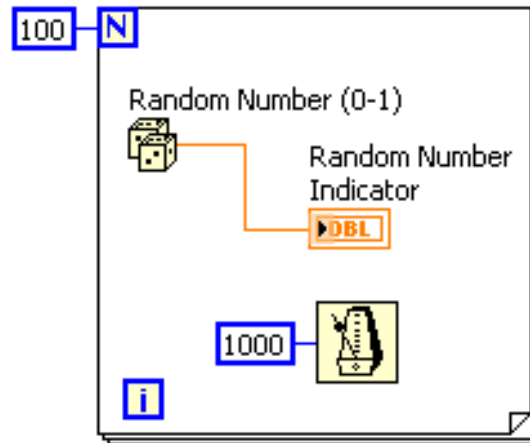

Figure 4.8

4.3.1 Wait Functions



The Wait Until Next ms Multiple function, shown in pg 80, monitors a millisecond counter and waits until the millisecond counter reaches a multiple of the amount you specify. Use this function to synchronize activities. Place this function within a loop to control the loop execution rate.



The Wait (ms) function, shown in pg 80, adds the wait time to the code execution time. This can cause a problem if code execution time is variable.

NOTE: The Time Delay Express VI, located on the Functions>>Execution Control palette, behaves similar to the Wait (ms) function with the addition of built-in error clusters. Refer to Clusters (Section 6.5) for more information about error clusters.

4.3.2 Wait Functions

LabVIEW can represent numeric data types as signed or unsigned integers (8-bit, 16-bit, or 32-bit), floating-point numeric values (single-, double-, or extended-precision), or complex numeric values (single-, double-, or extended-precision). When you wire two or more numeric inputs of different representations to a function, the function usually returns output in the larger or wider format. The functions coerce the smaller representations to the widest representation before execution, and LabVIEW places a coercion dot on the terminal where the conversion takes place.

For example, the For Loop count terminal is a 32-bit signed integer. If you wire a double-precision, floating-point numeric to the count terminal, LabVIEW converts the numeric to a 32-bit signed integer. A coercion dot appears on the count terminal of the first For Loop, as shown in Figure 4.9.

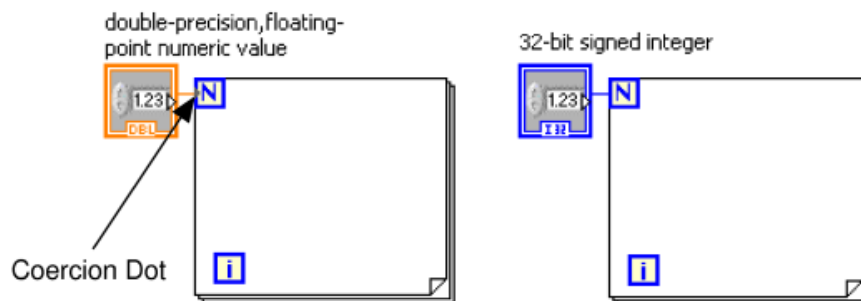

Figure 4.9

If you wire two different numeric data types to a numeric function that expects the inputs to be the same data type, LabVIEW converts one of the terminals to the same representation as the other terminal. LabVIEW chooses the representation that uses more bits. If the number of bits is the same, LabVIEW chooses unsigned over signed.

In the example in Figure 4.10, a 32-bit signed integer (I32) and a double-precision, floating-point numeric value (DBL) are wired to the Divide function. The 32-bit signed integer is coerced since it uses fewer bits than the double-precision, floating-point numeric value.

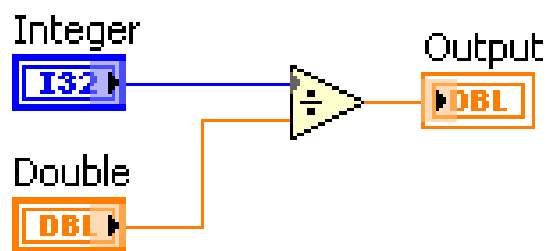

Figure 4.10

To change the representation of a numeric object, right-click the object and select Representation from the shortcut menu. Select the data type that best represents the data. ut data types.

When LabVIEW converts double-precision, floating-point numeric values to integers, it rounds to the nearest integer. LabVIEW rounds $x.5$ to the nearest even integer. For example, LabVIEW rounds 2.5 to 2 and 3.5 to 4.

Refer to the Data Types section of Introduction to LabVIEW, of this manual or to the LabVIEW Help for more information about data types.

4.4 Timed Temperature VI

Exercise 4.2:

Complete the following steps to build a VI that uses the Thermometer VI to read a temperature once every second for a duration of one minute.

4.4.1 Front Panel

1. Open a blank VI and build the front panel shown in Figure 4.11.

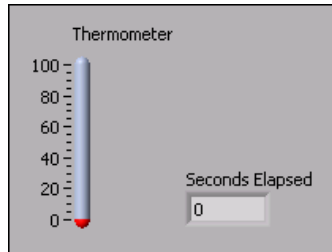

Figure 4.11

- (a) Place a thermometer, located on the Controls»Numeric Indicators palette, on the front panel. This provides a visual indication of the temperature reading.
- (b) Place a numeric indicator, located on the Controls»Numeric Indicators palette, on the front panel. Label this indicator Seconds Elapsed. Right-click the indicator and select Representation»I32 from the shortcut menu.

4.4.2 Block Diagram

1. Build the block diagram shown in Figure 4.12.

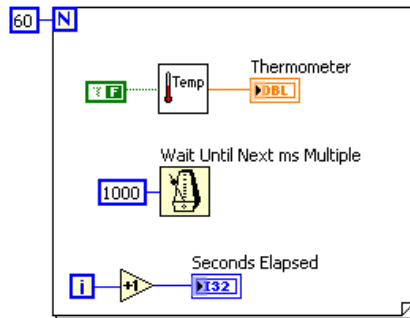



Figure 4.12

-  Place a For Loop, located on the Functions»All Functions»Structures palette, on the block diagram. Right-click the Loop Count terminal in the upper left corner of the For Loop and select Create Constant from the shortcut menu. Type 60 in the constant to set the For Loop to repeat 60 times.
-  Place the Thermometer VI on the block diagram. Select Functions»All Functions»Select a VI and navigate to C:\Exercises\LabVIEW Basics

I\Thermometer.vi to place the VI. This VI reads the temperature from the DAQ device. Right-click the Temp Scale input and select Create»Constant from the shortcut menu. Use a False constant for Fahrenheit or a True constant for Celsius.

NOTE: If you do not have a DAQ device with a temperature sensor on Channel 0, use the (Demo) Thermometer VI instead.



- Place the Wait Until Next ms Multiple function, located on the Functions»All Functions»Time & Dialog palette, on the block diagram. Right-click the input and select Create»Constant from the shortcut menu. Enter a value of 1000 to set the wait to every second.



- Place the Increment function, located on the Functions»Arithmetic & Comparison»Express Numeric palette, on the block diagram. This function adds one to the iteration terminal output.

2. Save this VI as Timed Temperature.vi in the C:\Exercises\LabVIEW Basics I directory.
3. Run the VI. The first reading might take longer than one second to retrieve if the computer needs to configure the DAQ device.
4. If time permits, complete the following optional and challenge steps, otherwise close the VI.

4.4.3 Optional

1. Build a VI that generates random numbers in a While Loop and stops when you click a stop button on the front panel.
2. Save the VI as General While Loop.vi in the C:\Exercises\LabVIEW Basics I directory.

4.4.4 Challenge

1. Modify the General While Loop VI to stop when the stop button is clicked or when the While Loop reaches a number of iterations specified by a front panel control.
2. Select File»Save As to save the VI as Combo While-For Loop.vi in the C:\Exercises\LabVIEW Basics I directory.

4.5 Accessing Previous Loop Data

When programming with loops, you often need to access data from previous iterations of the loop. For example, you may have a VI that reads the temperature and displays it on a graph. If you want to display a running average of the temperature as well, you need to use data generated in previous iterations. Two ways of accessing this data include the **shift register** and the **Feedback Node**.

4.5.1 Shift Registers

Use shift registers on For Loops and While Loops to transfer values from one loop iteration to the next. Shift registers are similar to static variables in text-based programming languages.

 A shift register appears as a pair of terminals, shown in pg 84, directly opposite each other on the vertical sides of the loop border. The right terminal contains an up arrow and stores data on the completion of an iteration. LabVIEW transfers the data connected to the right side of the register to the next iteration. Create a shift register by right-clicking the left or right border of a loop and selecting Add Shift Register from the shortcut menu.

A shift register transfers any data type and automatically changes to the data type of the first object wired to the shift register. The data you wire to the terminals of each shift register must be the same type.

To initialize a shift register, wire any value from outside the loop to the left terminal. If you do not initialize the shift register, the loop uses the value written to the shift register when the loop last executed or the default value for the data type if the loop has never executed.

Use a loop with an uninitialized shift register to run a VI repeatedly so that each time the VI runs, the initial output of the shift register is the last value from the previous execution. Use an uninitialized shift register to preserve state information between subsequent executions of a VI. After the loop executes, the last value stored in the shift register remains at the right terminal. If you wire the right terminal outside the loop, the wire transfers the last value stored in the shift register.

You can add more than one shift register to a loop. If you have multiple operations within a loop, use multiple shift registers to store the data values from those different processes in the structure. The block diagram in Figure 4.13 uses two initialized shift registers.

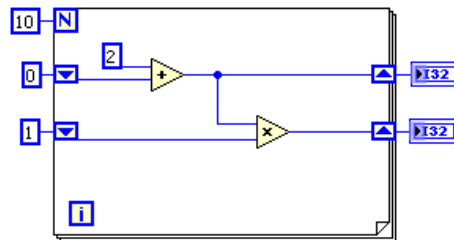

Figure 4.13

4.5.2 Stacked Shift Registers

To create a stacked shift register, right-click the left terminal and select Add Element from the shortcut menu. Stacked shift registers let you access data from previous loop iterations. Stacked shift registers remember values from previous iterations and carry those values to the next iterations.

Stacked shift registers, as shown in Figure 4.14, can only occur on the left side of the loop because the right terminal only transfers the data generated from the current iteration to the next iteration.

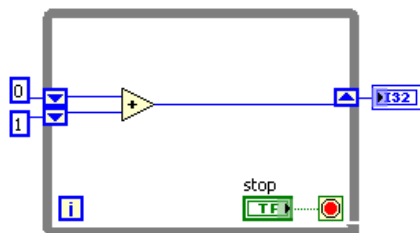



Figure 4.14

If you add two more elements to the left terminal, values from the last three iterations carry over to the next iteration, with the most recent iteration value stored in the top shift register. The second terminal stores the data passed to it from the previous iteration, and the bottom terminal stores data from two iterations ago.

4.5.3 Feedback Nodes

  The Feedback Node, shown in pg 85, appears automatically in a For Loop or While Loop if you wire the output of a subVI, function, or group of subVIs and functions to the input of that same VI, function, or group. Like a shift register, the Feedback Node stores data when the loop completes an iteration, sends that value to the next iteration of the loop, and transfers any data type. Use the Feedback Node to avoid unnecessarily long wires in loops. The Feedback Node arrow indicates in which direction the data flows along the wire.

You also can select the Feedback Node on the Structures palette and place it inside a For Loop or While Loop. If you place the Feedback Node on the wire before you branch the wire that connects the data to the tunnel, the Feedback Node passes each value to the tunnel. If you place the Feedback Node on the wire after you branch the wire that connects data to the tunnel, the Feedback Node passes each value back to the input of the VI or function and then passes the last value to the tunnel. The Accessing Previous Data VI (Section 4.6) exercise contains an example of this behavior.

4.6 Accessing Previous Data VI

Exercise 4.3:

4.6.1 Front Panel

1. Open the Feedback VI located in the C:\Exercises\LabVIEW Basics I directory. The front panel shown in Figure 4.15 is already built.

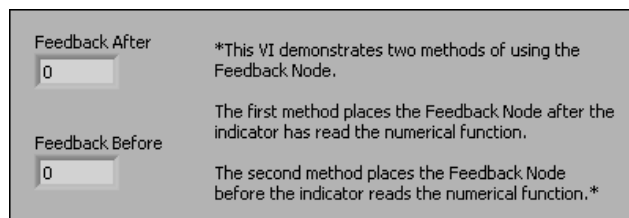

Figure 4.15

4.6.2 Block Diagram

1. Display the block diagram (Figure 4.16) and make sure both the front panel and block diagram are visible. If necessary, close or move the Tools and Functions palettes.

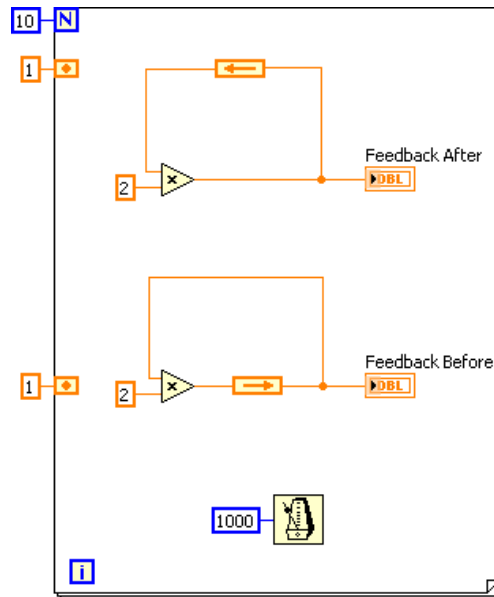

Figure 4.16

The 1 wired to the left terminals on the For Loop initializes the Feedback Node to 1. The Wait Until Next ms Timer slows the operation of the code. You also could use Highlight Execution instead of the wait function to slow the operation. The same code is used twice in this block diagram with the Feedback Node in a different portion of the wire.

4.6.3 Run the VI

1. Run the VI. The top section of the code reads the initialized Feedback Node and passes this value to the Multiply function. The bottom section of the code reads the initialized Feedback Node and passes this value to the indicator. This Multiply function does not execute until the next iteration of the loop.



2. Click the Highlight Execution button, shown in pg 86, to enable execution highlighting. Run the VI again to observe the order of execution. Turn off execution highlighting when you understand the execution order. The VI continues executing at normal speed.
3. Replace the bottom Feedback Node with a shift register, as shown in Figure 4.17.

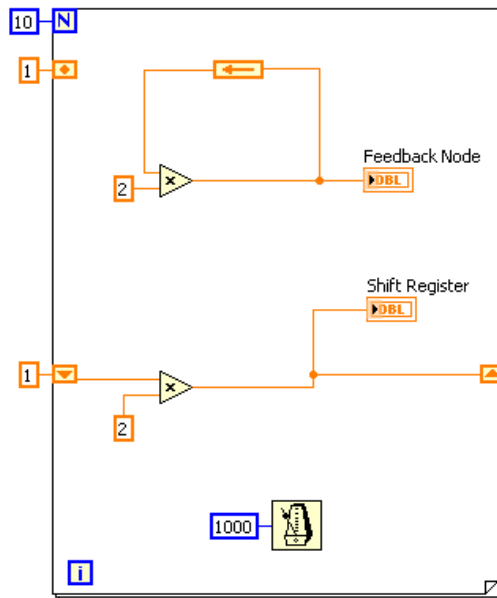

Figure 4.17

- (a) Select the bottom Feedback Node and press the <Delete key to delete it.
 - (b) Right-click the border of the For Loop and select Add Shift Register.
 - (c) Initialize the shift register by wiring 1 to the left shift register.
 - (d) Change the label of the bottom indicator to Shift Register and the top indicator to Feedback Node.
4. Run the VI. Notice that both the Feedback Node and the shift register portions of the block diagram have the same functionality.
 5. If time permits, complete the following optional steps; otherwise, close the VI and do not save changes.

4.6.4 Optional

1. Revise the shift register to display the last three iterations of the For Loop data, as shown in Figure 4.18.

- Coercion dots appear where LabVIEW coerces a numeric representation of one terminal to match the numeric representation of another terminal.
- Use shift registers on For Loops and While Loops to transfer values from one loop iteration to the next.
- Create a shift register by right-clicking the left or right border of a loop and selecting Add Shift Register from the shortcut menu.
- To configure a shift register to carry over values to the next iteration, right-click the left terminal and select Add Element from the shortcut menu.
- The Feedback Node stores data when the loop completes an iteration, sends that value to the next iteration of the loop, and transfers any data type.
- Use the Feedback Node to avoid unnecessarily long wires.

Solutions to Exercises in Chapter 4

Solution to Exercise 4.1:

This is an unsupported media type. To view, please see
<http://cnx.org/content/m12213/latest/AutoMatch.vi>

Chapter 5

Arrays

5.1 Arrays

Arrays group data elements of the same type. An array consists of elements and dimensions. Elements are the data that make up the array. A dimension is the length, height, or depth of an array. An array can have one or more dimensions and as many as $2^{31} - 1$ elements per dimension, memory permitting.

You can build arrays of numeric, Boolean, path, string, waveform, and cluster data types. Consider using arrays when you work with a collection of similar data and when you perform repetitive computations. Arrays are ideal for storing data you collect from waveforms or data generated in loops, where each iteration of a loop produces one element of the array.

You cannot create an array of arrays. However, you can create an array of **clusters**, where each cluster contains one or more arrays. Refer to Clusters (Section 6.1) for more information about clusters.

Array elements are ordered. An array uses an index so you can readily access any particular element. The index is zero-based, which means it is in the range 0 to $n - 1$, where n is the number of elements in the array. For example, if you create an array of the planets in the solar system, $n = 9$ for the nine planets, so the index ranges from 0 to 8. Earth is the third planet, so it has an index of 2.

5.1.1 Creating Array Controls and Indicators

To create an array control or indicator as shown in Figure 5.1, select an array on the Controls»All Controls»Array & Cluster palette, place it on the front panel, and drag a control or indicator into the array shell. If you attempt to drag an invalid control or indicator such as an XY graph into the array shell, you are unable to drop the control or indicator in the array shell.

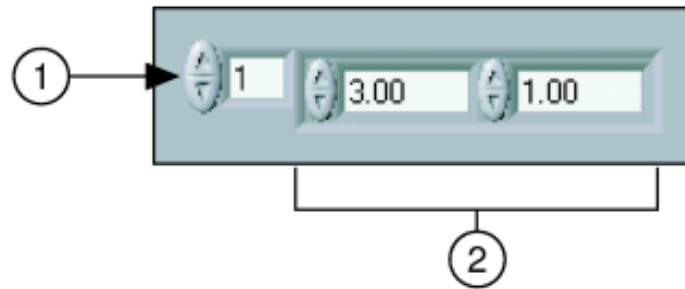

Figure 5.1: 1. Index Display, 2. Element Display

You must insert an object in the array shell before you use the array on the block diagram. Otherwise, the array terminal appears black with an empty bracket.

5.1.1.1 Two-Dimensional Arrays

A 2D array stores elements in a grid. It requires a column index and a row index, both of which are zero-based, to locate an element. Figure 5.2 shows a 6-column by 4-row 2D array, which contains $6 \times 4 = 24$ elements.

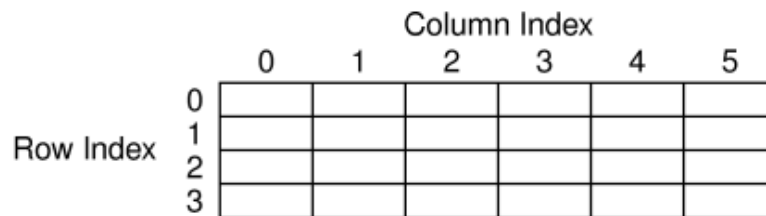

Figure 5.2

To add dimensions to an array one at a time, right-click the index display and select Add Dimension from the shortcut menu. You also can use the Positioning tool to resize the index display until you have as many dimensions as you want. Figure 5.3 is an example of an uninitialized 2D array control.

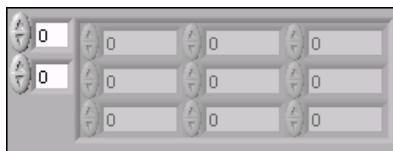

Figure 5.3

5.1.2 Creating Array Constants

You can create an array constant on the block diagram by selecting an array constant from the Functions»All Functions»Array palette, placing it on the block diagram, and dragging a constant into the array shell. Array constants are useful for passing data into a subVI.

5.2 Auto-Indexing

If you wire an array to a For Loop or While Loop input tunnel, you can read and process every element in that array by enabling auto-indexing. When you auto-index an array output tunnel, the output array receives a new element from every iteration of the loop. The wire from the output tunnel to the array indicator becomes thicker as it changes to an array at the loop border, and the output tunnel contains square brackets representing an array, as shown in Figure 5.4.

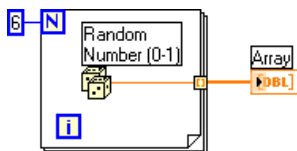

Figure 5.4

Disable auto-indexing by right-clicking the tunnel and selecting Disable Indexing from the shortcut menu. For example, disable auto-indexing if you need only the last value passed to the tunnel in the previous example.

Because you can use For Loops to process arrays an element at a time, LabVIEW enables auto-indexing by default for every array you wire to a For Loop and for each output tunnel that is created. Auto-indexing for While Loops is disabled by default. To enable auto-indexing, right-click a tunnel and select Enable Indexing from the shortcut menu.

5.2.1 Creating Two-Dimensional Arrays

You can use two For Loops, one inside the other, to create a 2-D array. The outer For Loop creates the row elements, and the inner For Loop creates the column elements, as shown in Figure 5.5.

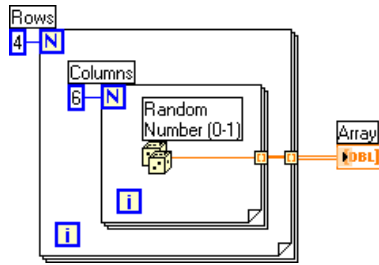

Figure 5.5

5.2.2 Using Auto-Indexing to Set the For Loop Count

If you enable auto-indexing on an array wired to a For Loop input terminal, LabVIEW sets the count terminal to the array size so you do not need to wire the count terminal.

In Figure 5.6, the For Loop executes a number of times equal to the number of elements in the array. Normally, if the count terminal of the For Loop is not wired, the run arrow is broken. However, in this case the run arrow is not broken.

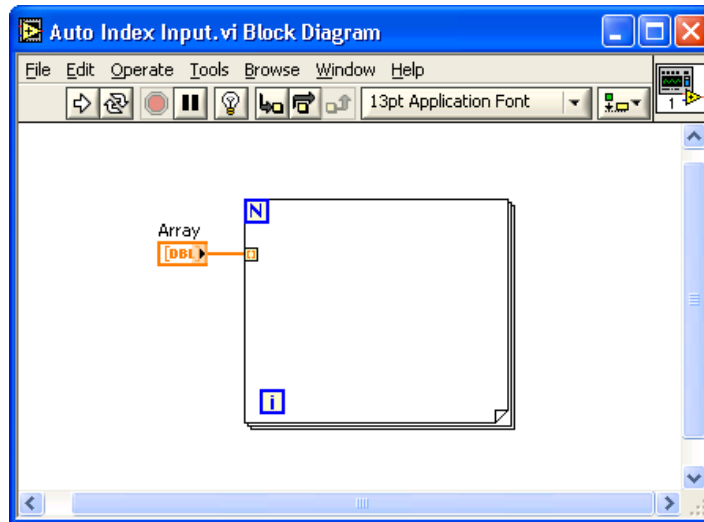



Figure 5.6

If you enable auto-indexing for more than one tunnel or if you wire the count terminal, the count changes to the smaller of the two. For example, if you wire an array with 10 elements to a For Loop input tunnel and you set the count terminal to 15, the loop executes only 10 times.

5.3 Array Functions

Use the Array functions located on the Functions>>All Functions>>Array palette to create and manipulate arrays. The more commonly used array functions include the following:

- **Array Size** -  Returns the number of elements in each dimension of an array. If the array is n -dimensional, the size output is an array of n elements. For example, the Array Size function returns a size of 3 for the following array.

7	4	2
---	---	---

- **Initialize Array** -  Creates an n -dimensional array in which every element is initialized to the value of element. Resize the function to increase the number of dimensions of the output array. For example, the Initialize Array function returns the following array for an element of 4, a dimension size of 3, and one dimension size terminal.

4	4	4
---	---	---

- **Array Subset** -  Returns a portion of an array starting at index and containing length elements. For example, if you use the previous array as the input, the Array Subset function returns the following array for an index of 2 and a length of 3.

2	4	4
---	---	---

- **Build Array** -  Concatenates multiple arrays or appends elements to an n -dimensional array. Resize the function to increase the number of elements in the output array. For example, if you concatenate the two previous arrays, the Build Array function returns the following array.

7	4	2
4	4	4

To concatenate the inputs into a longer array of the same dimension as shown in the following array, right-click the function node and select **Concatenate Inputs** from the shortcut menu to create the following array.

7	4	2	4	4	4
---	---	---	---	---	---

- **Index Array** -  Returns the element or sub-array of n -dimension array at index. For example, if you use the previous array as the input, the Index Array function returns 2 for an index of 0. You also can use the Index Array function to extract a row or column of a 2D array to create a subarray of the original. To do so, wire a 2D array to the input of the function. Two index terminals are available. The top index terminal indicates the row, and the second terminal indicates the column. You can wire inputs to both index terminals to index a single

element, or you can wire only one terminal to extract a row or column of data. For example, wire the following array to the input of the function.

7	4	2
4	4	4

The Index Array function returns the following array for an index (row) of 0:

7	4	2
---	---	---

5.4 Polymorphism

The Numeric functions located on the Functions»Express Numeric and Functions»All Functions»Numeric palettes are polymorphic. This means that the inputs to these functions can be different data structures, such as scalar values and arrays. For example, you can use the Add function to add a scalar value to an array or to add two arrays together. If you wire a scalar value of 2 and the following array to the Add function.

1	3	2
---	---	---

The function adds the scalar value to each element of the array and returns the following array:

3	5	4
---	---	---

If you wire the previous two arrays to the Add function, the function adds each element of one array to the corresponding element of the other array and returns the following array:

4	8	6
---	---	---

Wire two arrays of different sizes to the Add function, such as the previous array and the following array:

3	1	2	3
---	---	---	---

The function adds corresponding elements and returns the following array, which is the size of the smaller input array:

7	9	8
---	---	---

You use the Numeric functions with clusters the same way you use them with arrays of numeric values. Refer to Clusters (Section 6.1) for more information about clusters.

5.5 Array Exercise VI

Exercise 5.1:

Complete the following steps to build a VI that creates an array of random numbers, scales the resulting array, and takes a subset of that final array.

5.5.1 Front Panel

1. Open a blank VI and build the front panel shown in Figure 5.7.

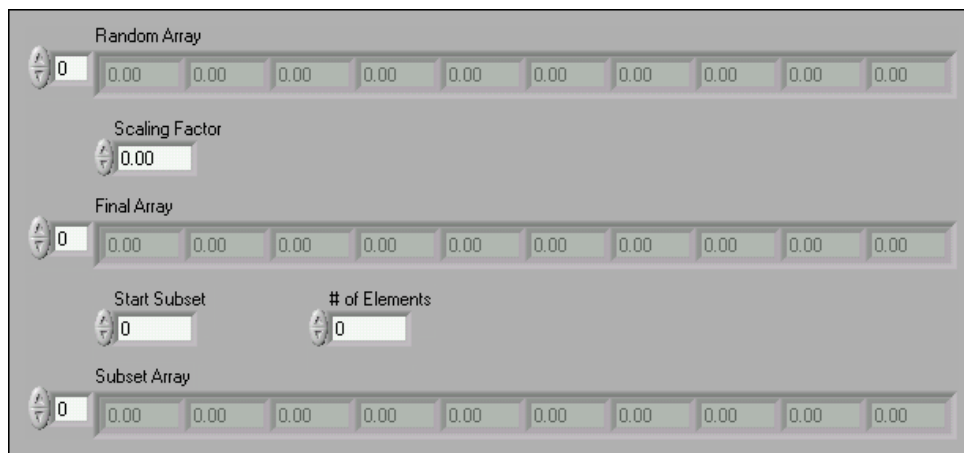

Figure 5.7

- Place an array, located on the Controls»All Controls»Array & Cluster palette, on the front panel.
- Label the array Random Array.
- Place a numeric indicator, located on the Controls»Numeric Indicators palette, in the array shell.
- Use the Positioning tool to resize the array control to contain 10 numeric indicators.
- Press the <Ctrl> key while you click and drag the Random Array control to create two copies of the control.
- Label the copies Final Array and Subset Array.
- Place three numeric controls, located on the Controls»Numeric Controls palette, and label them Scaling Factor, Start Subset, and # of Elements.
- Right-click the Start Subset and # of Elements controls and select Representation»I32 from the shortcut menu.
- Do not change the values of the front panel controls.

5.5.2 Block Diagram

1. Build the block diagram shown in Figure 5.8.

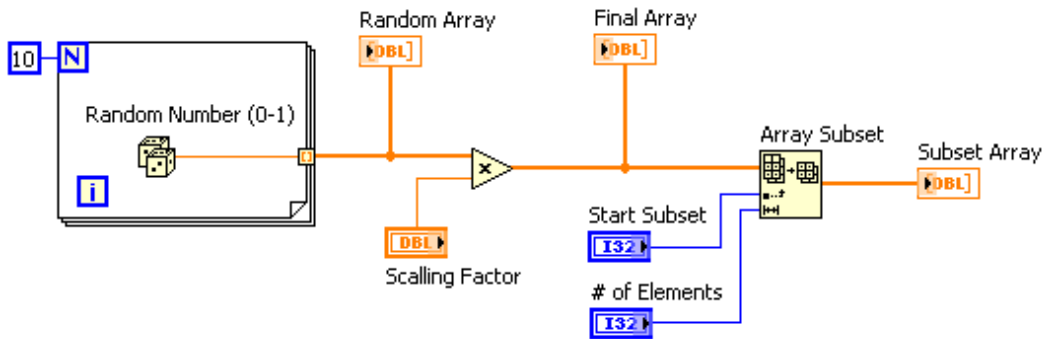





Figure 5.8

- (a)  Place the Random Number (0-1) function, located on the Functions>>Arithmetic & Comparison>>Express Numeric palette, on the block diagram. This function generates a random number between 0 and 1.
 - (b)  Place the For Loop, located on the Functions>>All Functions>>Structures palette, on the block diagram. The loop accumulates an array of 10 random numbers at the output tunnel. Create a constant of 10 for the count terminal.
 - (c)  Place the Multiply function, located on the Functions>>Arithmetic & Comparison>>Express Numeric palette, on the block diagram. In this exercise this function multiplies Random Array by Scaling Factor and returns Final Array.
 - (d)  Place the Array Subset function, located on the Functions>>All Functions>>Array palette, on the block diagram. This function returns a portion of an array starting at Start Subset and containing # of Elements elements.
2. Save the VI as Array Exercise.vi in the C:\Exercises\ LabVIEW Basics I directory.

5.5.3 Run the VI

1. Display the front panel, change the values of the controls, and run the VI a few times. The For Loop runs for 10 iterations. Each iteration generates a random number and stores it at the output tunnel. Random Array displays an array of 10 random numbers. The VI multiplies each value in Random Array by Scaling Factor to create Final Array. The VI takes a subset of Final Array starting at Start Subset for # of Elements and displays the subset in Subset Array.
2. Close the VI.

5.6 Summary, Tips, and Tricks on Arrays

- **Arrays** group data elements of the same type. You can build arrays of numeric, Boolean, path, string, waveform, and cluster data types.

- The array index is zero-based, which means it is in the range 0 to $n - 1$, where n is the number of elements in the array.
- You must insert an object in the array shell before you use the array on the block diagram. Otherwise, the array terminal appears black with an empty bracket.
- To create an array control or indicator, select an array on the Controls»Array & Cluster palette, place it on the front panel, and drag a control or indicator into the array shell.
- If you wire an array to a For Loop or While Loop input tunnel, you can read and process every element in that array by enabling auto-indexing.
- Use the Array functions located on the Functions»All Functions»Array palette to create and manipulate arrays.
- By default, LabVIEW enables auto-indexing in For Loops and disables auto-indexing in While Loops.
- **Polymorphism** is the ability of a function to adjust to input data of different data structures.

5.7 Additional Exercises for Arrays

Exercise 5.2:

Build a VI that reverses the order of an array that contains 100 random numbers. For example, array[0] becomes array[99], array[1] becomes array[98], and so on.

TIP: Use the Reverse 1D Array function located on the Functions»All Functions»Array palette to reverse the array order.

Save the VI as Reverse Random Array.vi in the C:\Exercises\LabVIEW Basics I directory.

Exercise 5.3:

Build a VI that accumulates an array of temperature values using the Thermometer (Section 3.5) VI. Set the array size with a control on the front panel. Initialize an array using the Initialize Array function of the same size where all the values are equal to 10. Add the two arrays, calculate the size of the final array, and extract the middle value from the final array. Display the Temperature Array, Initialized Array, Final Array, and Mid Value.

Save the VI as Find Mid Value.vi in the C:\Exercises\LabVIEW Basics I directory.

Exercise 5.4:

Build a VI that generates a 2D array of three rows by 10 columns that contains random numbers. After generating the array, index each row, and plot each row on its own graph. The front panel should contain three graphs.

Save the VI as Extract 2D Array.vi in the C:\Exercises\LabVIEW Basics I directory.

Exercise 5.5:

Build a VI that simulates the roll of a die with possible values 1 through 6 and records the number of times that the die rolls each value. The input is the number of times to roll the die, and the outputs include the number of times the die falls on each possible value. Use only one shift register.

Save the VI as Die Roller.vi in the C:\Exercises\LabVIEW Basics I directory.

Exercise 5.6:

Build a VI that generates a 1D array and then multiplies pairs of elements together, starting with elements 0 and 1, and returns the resulting array. For example, the input array with values {1, 23, 10, 5, 7, 11} results in the output array {23, 50, 77}.

TIP: Use the Decimate 1D Array function located on the Functions»All Functions»Array palette.

Save the VI as Array Pair Multiplier.vi in the C:\Exercises\LabVIEW Basics I directory.

Chapter 6

Clusters

6.1 Clusters

Clusters group data elements of mixed types, such as a bundle of wires, as in a telephone cable, where each wire in the cable represents a different element of the cluster. A cluster is similar to a record or a struct in text-based programming languages.

Bundling several data elements into clusters eliminates wire clutter on the block diagram and reduces the number of connector pane terminals that subVIs need. The connector pane has, at most, 28 terminals. If a front panel contains more than 28 controls and indicators that you want to use programmatically, group some of them into a cluster and assign the cluster to a terminal on the connector pane. Like an array, a cluster is either a control or an indicator. A cluster cannot contain a mixture of controls and indicators.

Although cluster and array elements are both ordered, you must unbundle all cluster elements at once rather than index one element at a time. You also can use the Unbundle By Name function to access specific cluster elements.

6.1.1 Creating Cluster Controls and Indicators

To create a cluster control or indicator, select a cluster on the Controls»All Controls»Array & Cluster palette, place it on the front panel, and drag controls or indicators into the cluster shell. Resize the cluster shell by dragging the cursor while you place the cluster shell.

The example in Figure 6.1 is a cluster of three controls.

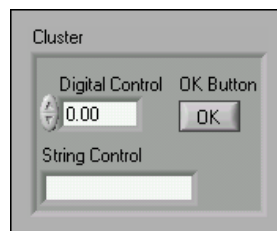

Figure 6.1

6.1.2 Creating Cluster Constants

Create a cluster constant on the block diagram by selecting a cluster constant on the Cluster palette, placing it on the block diagram, and dragging a constant into the cluster shell.

If you have a cluster control or indicator on the front panel and you want to create a cluster constant containing the same elements on the block diagram, you can either drag that cluster from the front panel to the block diagram or right-click the cluster on the front panel and select **Create»Constant** from the shortcut menu.

6.1.3 Cluster Order

Cluster elements have a logical order unrelated to their position in the shell. The first object you place in the cluster is element 0, the second is element 1, and so on. If you delete an element, the order adjusts automatically.

The cluster order determines the order in which the elements appear as terminals on the **Bundle** and **Unbundle** functions on the block diagram.

You can view and modify the cluster order by right-clicking the cluster border and selecting **Reorder Controls In Cluster** from the shortcut menu. The toolbar and cluster change, as shown in Figure 6.2.

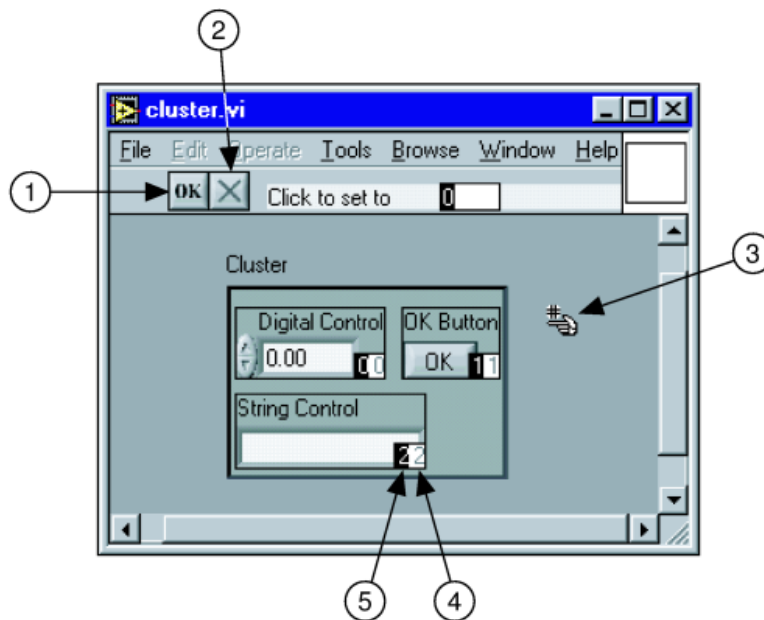

Figure 6.2: 1. Confirm Button, 2. Cancel Button, 3. Cluster Order Cursor, 4. Current Order, 5. New Order

The white box on each element shows its current place in the cluster order. The black box shows the new place in the order for an element. To set the order of a cluster element, type the new order number in the **Click to set to** text box and click the element. The cluster order of the element changes, and the cluster order of other elements adjusts. Save the changes by clicking the **Confirm** button on the toolbar. Revert to the original order by clicking the **Cancel** button.

Corresponding elements, determined by the cluster order, must have compatible data types. For example, in one cluster, element 0 is a numeric control, and element 1 is a string control. In a second cluster, element 0 is a numeric indicator, and element 1 is a string indicator. The cluster control correctly wires to the cluster indicator.

However, if you change the cluster order of the indicator so the string is element 0, and the numeric is element 1, the wire from the cluster control to the cluster indicator appears broken, indicating that the data types do not match.

6.2 Cluster Functions

Use the Cluster functions located on the Functions»All Functions»Cluster palette to create and manipulate clusters. Use the Bundle and Bundle by Name functions to assemble and manipulate clusters and use the Unbundle and Unbundle by Name functions to disassemble clusters.

You also can create the Bundle, Bundle by Name, Unbundle, and Unbundle by Name functions by right-clicking a cluster terminal on the block diagram and selecting Cluster Palette from the shortcut menu. The Bundle and Unbundle functions automatically contain the correct number of terminals. The Bundle by Name and Unbundle by Name functions appear with the first element in the cluster. Use the Positioning tool to resize the Bundle by Name and Unbundle by Name functions to show the other elements of the cluster.

6.2.1 Assembling Clusters

Use the Bundle function to assemble a cluster from individual elements or to change the values of individual elements in an existing cluster without having to specify new values for all elements. Use the Positioning tool to resize the function or right-click an element input and select Add Input from the shortcut menu. If you wire a cluster to the cluster input, the number of inputs must match the number of elements in the input cluster.

If you wire the cluster input, you can wire only the elements you want to change. For example, the cluster in Figure 6.3 contains three controls.

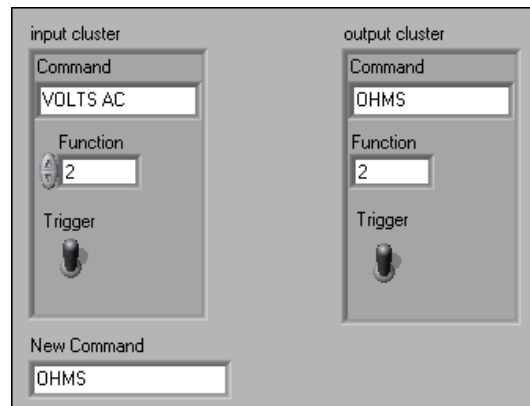

Figure 6.3

If you know the cluster order, you can use the Bundle function to change the Command value by wiring the elements shown in Figure 6.4.

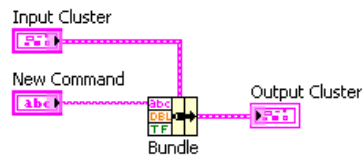

Figure 6.4

6.2.2 Replacing or Accessing Cluster Elements

Use the Bundle by Name function to replace or access labeled elements of an existing cluster. Bundle by Name works similarly to the Bundle function, but instead of referencing cluster elements by their cluster order, it references them by their owned labels. You can access only elements with owned labels. The number of inputs does not need to match the number of elements in output cluster.

Use the Operating tool to click an input terminal and select an element from the pull-down menu. You also can right-click the input and select the element from the Select Item shortcut menu.

In Figure 6.5, you can use the Bundle by Name function to change Command and Function.

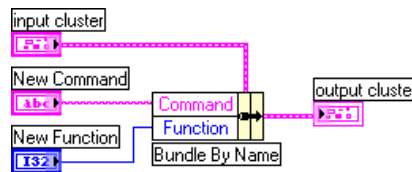

Figure 6.5

Use the Bundle by Name function for data structures that might change during development. If you add a new element to the cluster or modify its order, you do not need to rewire the Bundle by Name function because the names still are valid.

6.2.3 Disassembling Clusters

Use the Unbundle function to split a cluster into its individual elements.

Use the Unbundle by Name function to return the cluster elements whose names you specify. The number of output terminals does not depend on the number of elements in the input cluster.

Use the Operating tool to click an output terminal and select an element from the pull-down menu. You also can right-click the output terminal and select the element from the Select Item shortcut menu.

For example, if you use the Unbundle function with the cluster in Figure 6.6, it has four output terminals that correspond to the four controls in the cluster. You must know the cluster order so you can associate the correct Boolean terminal of the unbundled cluster with the corresponding switch in the cluster. In Figure 6.6, the elements are ordered from top to bottom starting with element 0. If you use the Unbundle by Name function, you can have an arbitrary number of output terminals and access individual elements by name in any order.

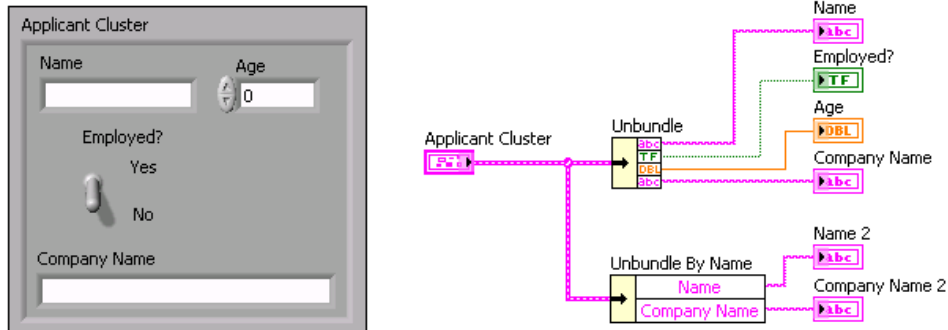

Figure 6.6

6.3 Cluster Exercise VI

Exercise 6.1:

6.3.1 Front Panel

1. Open a blank VI and build the front panel in Figure 6.7.

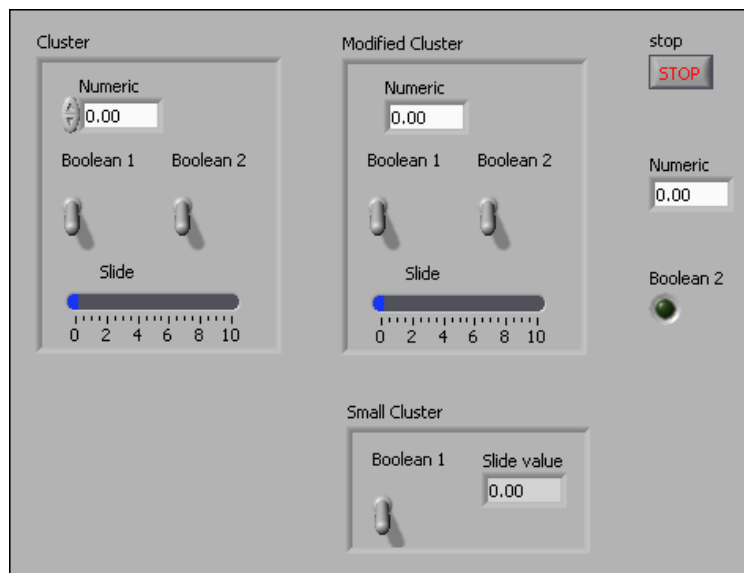

Figure 6.7

- (a) Place a stop button, located on the Controls»Buttons & Switches palette, a numeric indicator, located on the Controls»Numeric Indicators palette, and a round LED, located on the Controls»LEDs palette, on the front panel.

- (b) Place a cluster, located on the Controls»All Controls»Array & Cluster palette, on the front panel.
 - (c) Place a numeric control, located on the Controls»Numeric Controls palette, two vertical toggle switches, located on the Controls»Buttons & Switches palette, and a horizontal fill slide, located on the Controls»Numeric Controls palette, in the cluster.
 - (d) Create the Modified Cluster by duplicating the first cluster and relabeling it. Right-click the shell of Modified Cluster, and select Change to Indicator from the shortcut menu.
 - (e) Copy Modified Cluster and relabel it to create Small Cluster. Remove the second toggle switch and horizontal fill slide indicators. Relabel the numeric indicator to Slide value. Resize the cluster as shown in Figure 6.7.
2. Verify the cluster order of Cluster and Small Cluster. Modified Cluster should have the same order as Cluster.
 - (a) Right-click the boundary of each cluster and select Reorder Controls in Cluster from the shortcut menu.
 - (b) Confirm the cluster orders (Figure 6.8).

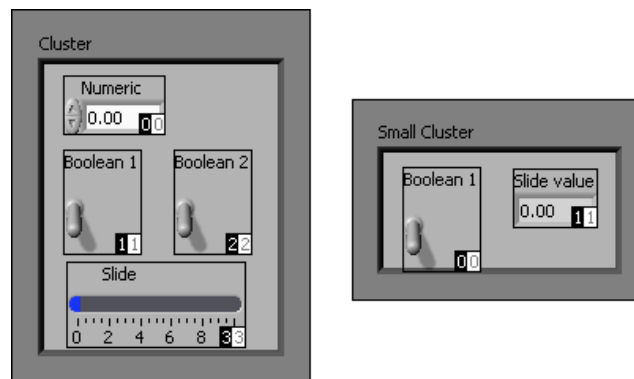

Figure 6.8

6.3.2 Block Diagram

1. Build the block diagram in Figure 6.9.

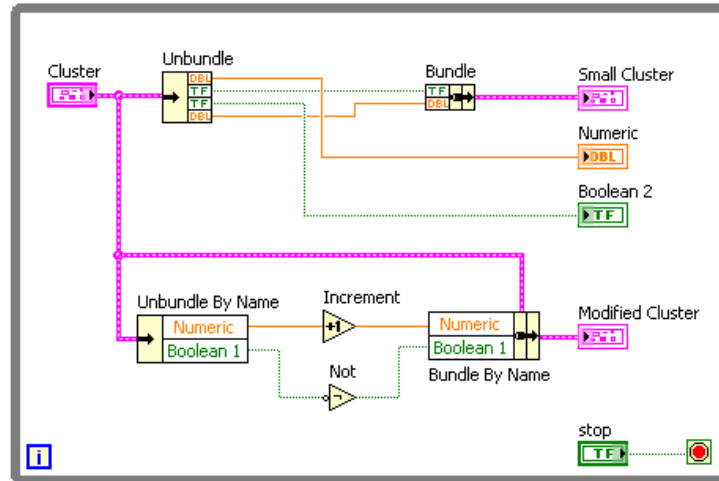



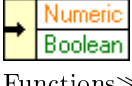





Figure 6.9

- (a)  Place the While Loop, located on the Functions»All Functions»Structures palette, on the block diagram.
- (b)  Place the Unbundle function, located on the Functions»All Functions»Cluster palette, on the block diagram. This function disassembles Cluster. Wire the input cluster to resize the function automatically.
- (c)  Place the Bundle function, located on the Functions»All Functions»Cluster palette, on the block diagram. This function assembles Small Cluster.
- (d)  Place the Unbundle by Name function, located on the Functions»All Functions»Cluster palette, on the block diagram. This function returns two elements from Cluster. Resize this function to have two output terminals. If a label name is not correct, right-click the name and select the correct name from the Select Item shortcut menu.
- (e)  Place the Increment function, located on the Functions»All Functions»Numeric palette, on the block diagram. This function adds one to the value of Numeric.
- (f)  Place the Not function, located on the Functions»Arithmetic & Comparison»Express Boolean palette, on the block diagram. This function returns the logical opposite of the value of the Boolean terminal of the Unbundle by Name function.
- (g)  Place the Bundle by Name function, located on the Functions»All Functions»Cluster palette, on the block diagram. This function replaces the values of Numeric and Boolean 1 in Cluster and creates Modified Cluster. Resize

this function to have two input terminals. If a label name is not correct, right-click the name and select the correct name from the Select Item shortcut menu.

(h) Complete the block diagram and wire the objects as shown in Figure 6.9.

2. Save the VI as Cluster Exercise.vi in the C:\Exercises\LabVIEW Basics I directory.

6.3.3 Run the VI

1. Display the front panel and run the VI.
2. Enter different values in Cluster and run the VI again. Notice how values entered in Cluster affect the Modified Cluster and Small Cluster indicators. Is this the behavior you expected?
3. Try changing the cluster order of Modified Cluster. Run the VI. How did the changed order affect the behavior?
4. Close the VI. Do not save changes.

6.4 Cluster Scaling VI

Exercise 6.2:

Complete the following steps to build a VI that scales values stored in a cluster, where each cluster element has a different scale factor. Assume that the voltages were measured from transducers that measure the pressure, flow rate, and temperature. The VI then scales these values to get the actual values present in the system.

6.4.1 Front Panel

1. Open the Cluster Scaling VI located in the C:\Exercises\LabVIEW Basics I directory. The front panel is already built.
2. Change the controls as shown in Figure 6.10.

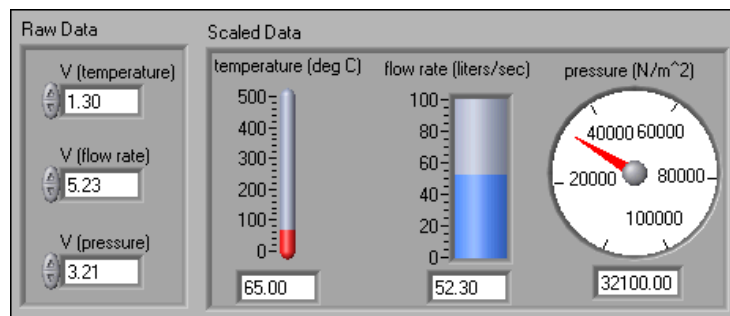

Figure 6.10

6.4.2 Block Diagram

1. Build the block diagram shown in Figure 6.11. Make sure you apply the correct scale factors to each element in the Raw Data cluster.

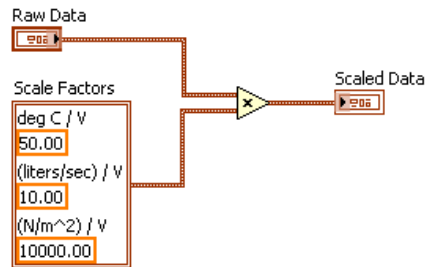

Figure 6.11

2. Save the VI.
3. Display the front panel and run the VI.
4. Change the front panel controls and run the VI again.
5. Close the VI when you are finished.

6.5 Error Clusters

No matter how confident you are in the VI you create, you cannot predict every problem a user might encounter. Without a mechanism to check for errors, you know only that the VI does not work properly. Error checking tells you why and where errors occur.

When you perform any kind of I/O, consider the possibility that errors will occur. Almost all I/O functions return error information. Include error checking in VIs, especially for I/O operations such as file, serial, instrumentation, data acquisition, and communication operations, and provide a mechanism to handle errors appropriately.

Checking for errors in VIs can help you identify the following problems:

- You initialized communications incorrectly or wrote improper data to an external device.
- An external device lost power, is broken, or is not working properly.
- You upgraded the operating system software, which changed the path to a file or the functionality of a VI or library. You might notice a problem in a VI or a system program.

6.5.1 Error Handling

By default, LabVIEW automatically handles any error that occurs when a VI runs by suspending execution, highlighting the subVI or function where the error occurred, and displaying a dialog box. You can choose other error handling methods. For example, if an I/O VI on the block diagram times out, you might not want the entire application to stop. You also might want the VI to retry for a certain period of time. In LabVIEW, you can make these error handling decisions on the block diagram of the VI.

VIs and functions return errors in one of two ways—with numeric error codes or with an error cluster. Typically, functions use numeric error codes, and VIs use an error cluster, usually with error inputs and outputs.

Error handling in LabVIEW follows the dataflow model. Just as data flow through a VI, so can error information. Wire the error information from the beginning of the VI to the end. Include an error handler VI at the end of the VI to determine if the VI ran without errors. Use the error in and error out clusters in each VI you use or build to pass error information through the VI.

As the VI runs, LabVIEW tests for errors at each execution node. If LabVIEW does not find any errors, the node executes normally. If LabVIEW detects an error, the node passes the error to the next node without executing. The next node does the same thing, and so on. Use the Simple Error Handler VI, shown in Figure 6.12, to handle the error at the end of the execution flow. The Simple Error Handler VI is located on the Functions>>All Functions>>Time & Dialog palette. Wire the error cluster to the error in input.

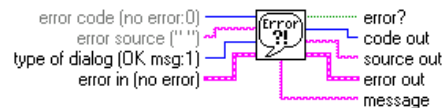

Figure 6.12

6.5.2 Error Clusters

The error clusters located on the Functions>>All Functions>>Array & Cluster palette include the components of information shown in Figure 6.13.

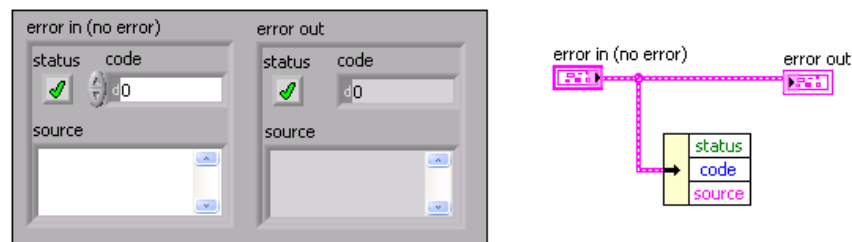

Figure 6.13

- **status** is a Boolean value that reports True if an error occurred. Most VIs, functions, and structures that accept Boolean data also recognize this parameter. For example, you can wire an error cluster to the Boolean inputs of the Stop, Quit LabVIEW, or Select functions. If an error occurs, the error cluster passes a True value to the function.
- **code** is a 32-bit signed integer that identifies the error numerically. A non-zero error code coupled with a **status** of False signals a warning rather than a fatal error.
- **source** is a string that identifies where the error occurred.

Use the error cluster controls and indicators to create error inputs and outputs in subVIs.

6.5.3 Explain Error

When an error occurs, right-click within the cluster border and select Explain Error from the shortcut menu to open the Explain Error dialog box. The Explain Error dialog box contains information about the error. The shortcut menu includes an Explain Warning option if the VI contains warnings but no errors.

You also can access the Explain Error dialog box from the Help»»Explain Error menu.

6.5.4 Using While Loops for Error Handling

You can wire an error cluster to the conditional terminal of a While Loop to stop the iteration of the While Loop (Figure 6.14). When you wire the error cluster to the conditional terminal, only the True or False value of the status parameter of the error cluster is passed to the terminal. When an error occurs, the While Loop stops.

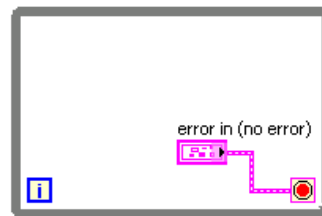

Figure 6.14

When an error cluster is wired to the conditional terminal, the shortcut menu items Stop if True and Continue if True change to Stop on Error and Continue while Error.

6.6 Summary, Tips, and Tricks on Clusters

- **Clusters** group data elements of mixed types. A cluster cannot contain a mixture of controls and indicators.
- If a front panel contains more than 28 controls and indicators that you want to use programmatically, group some of them into a cluster and assign the cluster to a terminal on the connector pane to eliminate clutter on the block diagram.
- To create a cluster control or indicator, select a cluster on the Functions»»All Functions»»Array & Cluster palette, place it on the front panel, and drag controls or indicators into the cluster shell.
- Use the Cluster functions located on the Functions»»All Functions»»Cluster palette to create and manipulate clusters.
- Error checking tells you why and where errors occur.
- The error cluster reports the **status**, **code**, and **source** of the error.
- Use the error cluster controls and indicators to create error inputs and outputs in subVIs.

Chapter 7

Plotting Data

7.1 Waveform Charts

The **waveform chart** is a numeric indicator that displays one or more plots. The waveform chart is located on the Controls»Graph Indicators palette. Waveform charts can display single or multiple plots. Figure 7.1 shows the elements of a multiplot waveform chart. Two plots are displayed: Raw Data and Running Avg.

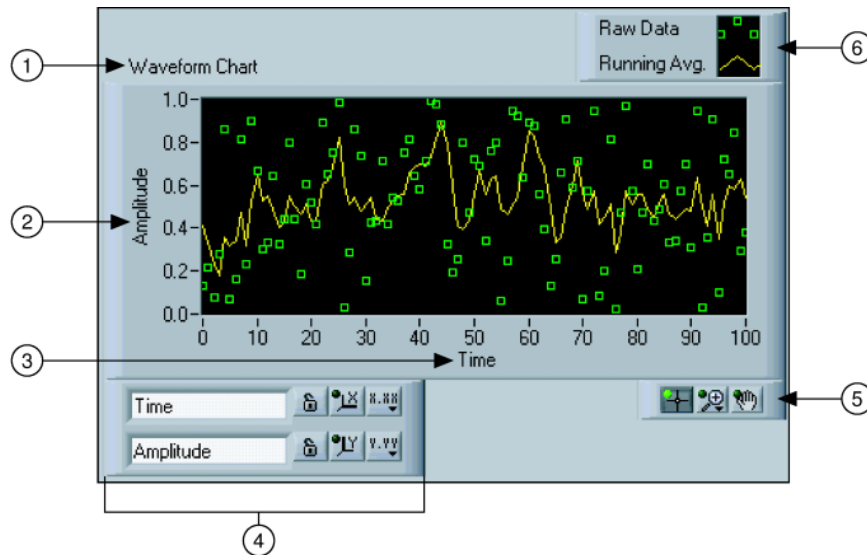

Figure 7.1

Charts use three different modes to scroll data, as shown in the Figure 7.2. Right-click the chart and select Advanced»Update Mode from the shortcut menu. Select Strip Chart, Scope Chart, or Sweep Chart . The default mode is Strip Chart.

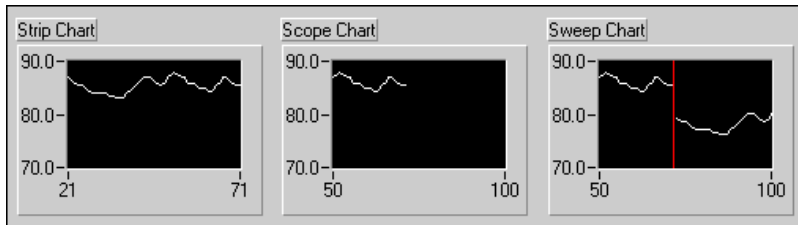

Figure 7.2

A strip chart shows running data continuously scrolling from left to right across the chart. A scope chart shows one item of data, such as a pulse or wave, scrolling partway across the chart from left to the right. A sweep chart is similar to an EKG display. A sweep chart works similarly to a scope except it shows the older data on the right and the newer data on the left separated by a vertical line. The scope chart and sweep chart have retracing displays similar to an oscilloscope. Because there is less overhead in retracing a plot, the scope chart and the sweep chart display plots significantly faster than the strip chart.

7.1.1 Wiring Charts

You can wire a scalar output directly to a waveform chart. The data type in the waveform chart in Figure 7.3 terminal matches the input data type.

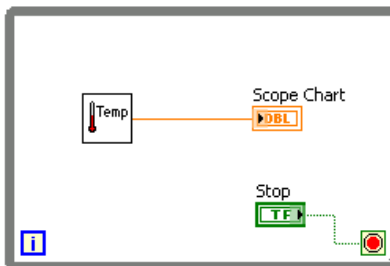

Figure 7.3

Waveform charts can display multiple plots. Bundle multiple plots together using the Bundle function located on the Cluster palette. In Figure 7.4, the Bundle function bundles the outputs of the three VIs to plot on the waveform chart.

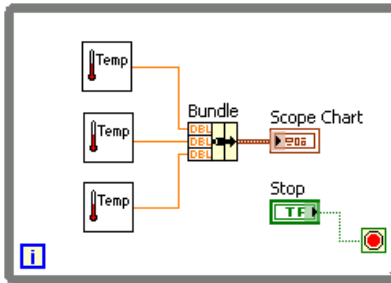

Figure 7.4

The waveform chart terminal changes to match the output of the Bundle function. To add more plots, use the Positioning tool to resize the Bundle function.

7.2 Temperature Monitor VI

Exercise 7.1:

Complete the following steps to build a VI that measures temperature and displays it on a waveform chart.

7.2.1 Front Panel

1. Open a blank VI and build the front panel shown in Figure 7.5.

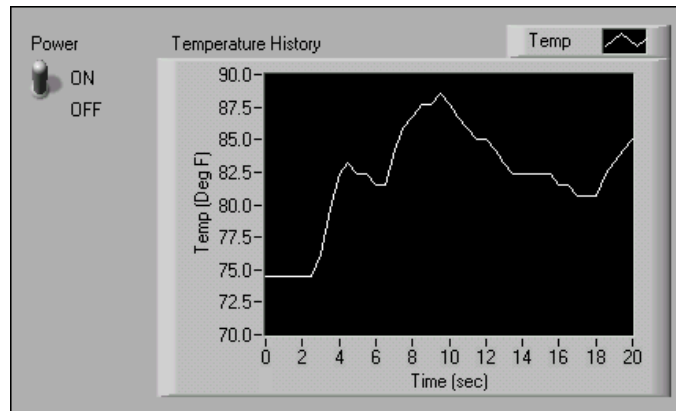



Figure 7.5

- Place the vertical toggle switch, located on the Controls»Buttons & Switches palette, on the front panel. Label this switch Power. You use the switch to stop the acquisition.
- Place a waveform chart, located on the Controls»Graph Indicators palette, on the front panel. Label the chart Temperature History. The waveform chart displays the temperature in real time.

- (c)  The waveform chart legend labels the plot Plot 0. Use the Labeling tool to triple-click Plot 0 in the chart legend, and change the label to Temp.
- (d) The temperature sensor measures room temperature. Use the Labeling tool to double-click 10.0 in the y-axis and type 90 to rescale the chart. Leave the x-axis in its default state.
- (e) Change -10.0 in the y-axis to 70.
- (f) Label the y-axis Temp (Deg F) and the x-axis Time (sec).

7.2.2 Block Diagram

1. Select Window \gg Show Block Diagram to display the block diagram.
2. Enclose the two terminals in a While Loop, as shown in the block diagram (Figure 7.6).

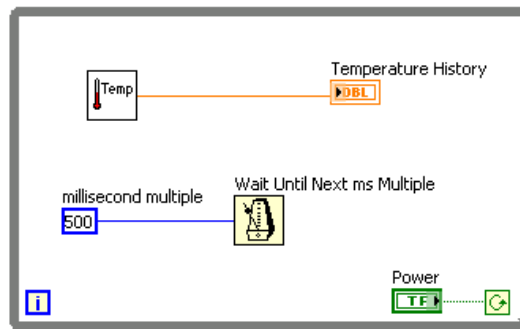





Figure 7.6

3. Right-click the conditional terminal and select Continue if True.
4. Wire the objects as shown in Figure 7.6.

- (a)  Place the Thermometer VI on the block diagram. Select Functions \gg All Functions \gg Select a VI and navigate to C:\Exercises\LabVIEW Basics I\Thermometer.vi. This subVI returns one temperature measurement from the temperature sensor.

NOTE: Use the (Demo) Thermometer VI if you do not have a DAQ device available.

- (b)  Place the Wait Until Next ms Multiple function, located on the Functions \gg All Functions \gg Time & Dialog palette, on the block diagram.
- (c)  Right-click the millisecond multiple input of the Wait Until Next ms Multiple function, select Create \gg Constant from the shortcut menu, type 500, and press the <Enter> key. The numeric constant specifies a wait of 500ms so the loop executes once every half-second.

NOTE: To measure temperature in Celsius, wire a Boolean True constant located on the Functions»Arithmetic & Comparison»Express Boolean palette to the Temp Scale input of the Thermometer VI. Change the scales on charts and graphs in subsequent exercises to a range of 20 to 32 instead of 70 to 90.

5. Save the VI as Temperature Monitor.vi in the C:\Exercises\LabVIEW Basics I directory.

7.2.3 Run the VI

1. Display the front panel by clicking it or by selecting Window»Show Front Panel.
2. Use the Operating tool to click the vertical toggle switch and turn it to the ON position.
3. Run the VI. The subdiagram within the While Loop border executes until the specified condition is True. For example, while the switch is on (True), the Thermometer VI takes and returns a new measurement and displays it on the waveform chart.
4. Click the vertical toggle switch to stop the acquisition. The condition is False, and the loop stops executing.

7.2.4 Front Panel

1. Format and customize the x- and y-scales of the waveform chart.
 - (a) Right-click the chart and select Properties from the shortcut menu to display the Chart Properties dialog box.
 - (b) Click the Format and Precision tab. Select Deg F (Y-axis) in the top pull-down menu. Set the Digits of precision to 1.
 - (c) Click the Plots tab and select different styles for the y-axis, as shown in Figure 7.7.

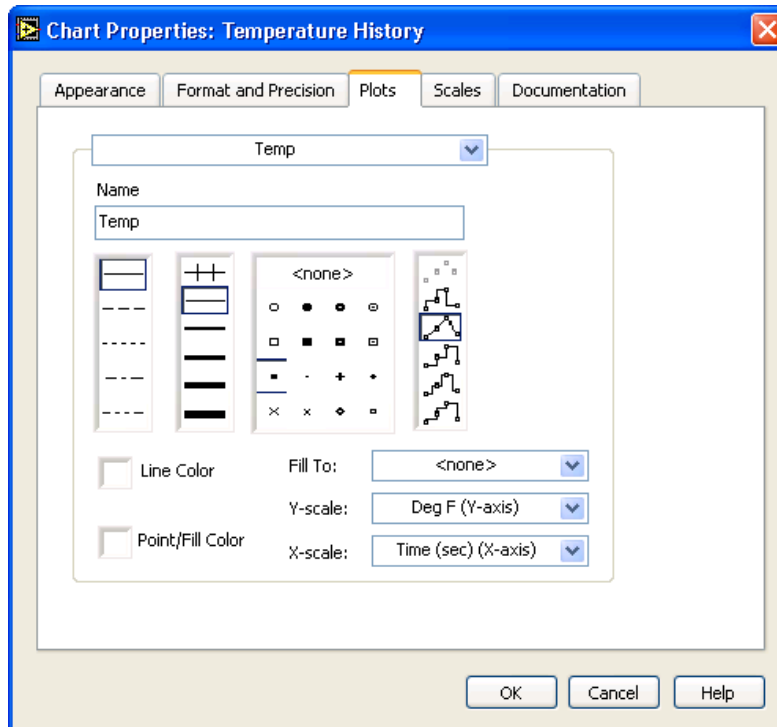

Figure 7.7

- (d) Select the Scales tab and select the Time (sec) (X-axis) in the top pull-down menu. Set the scale options as shown in Figure 7.8. Set the Multiplier to 0.50 to account for the 500 ms Wait function.

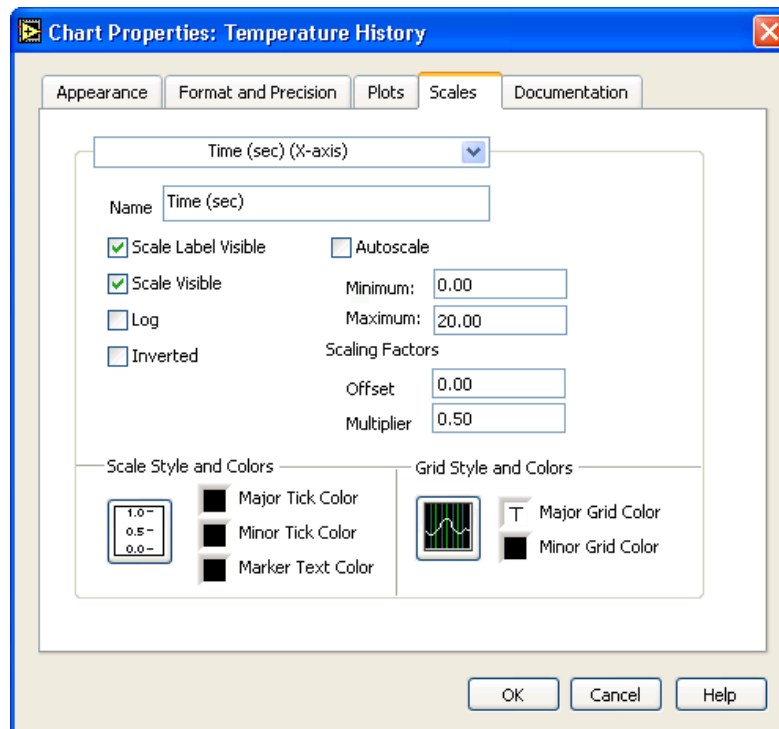

Figure 7.8

- (e) In the Scales tab, select the Deg F (Y-axis) in the top pull-down menu. Set the scale options as shown in Figure 7.9.

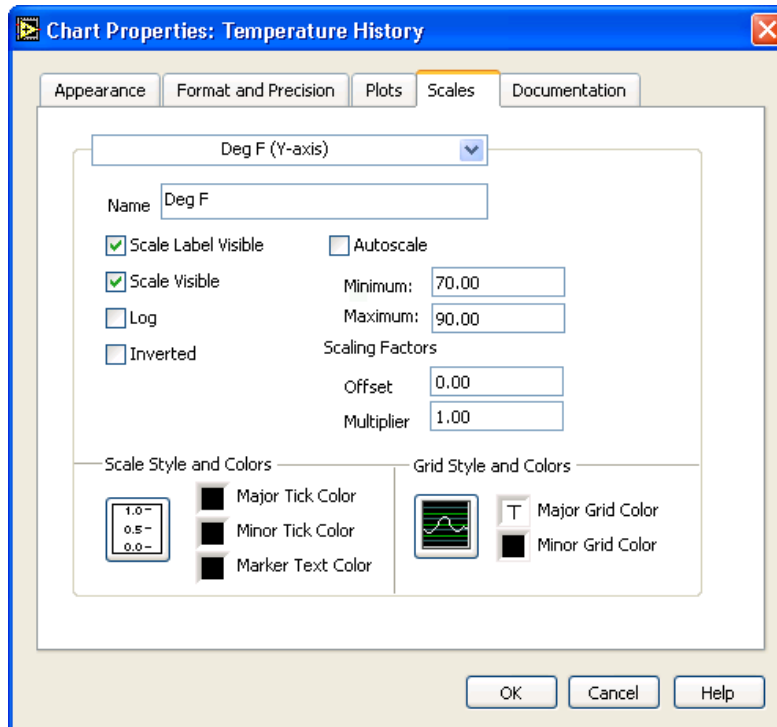



Figure 7.9

- (f) Click the OK button to close the dialog box when finished.
- Right-click the waveform chart and select Data Operations»Clear Chart from the shortcut menu to clear the display buffer and reset the waveform chart.

TIP: When a VI is running, you can select Clear Chart from the shortcut menu.
 - Each time you run the VI, you first must turn on the vertical toggle switch and then click the Run button due to the current mechanical action of the switch. Modify the mechanical action of the vertical toggle switch so temperature is plotted on the graph each time you run the VI, without having to first set the toggle switch.
 - Stop the VI if it is running.
 - Use the Operating tool to click the vertical toggle switch and turn it to the ON position.
 - Right-click the switch and select Data Operations»Make Current Value Default from the shortcut menu. This sets the ON position as the default value.
 -  Right-click the switch and select Mechanical Action»Latch When Pressed from the shortcut menu. This setting changes the control value when you click it and retains the new value until the VI reads it once. At this point the control reverts to its default value, even if you keep pressing the mouse button. This action is similar to a circuit breaker and is useful for stopping While Loops or for getting the VI to perform an action only once each time you set the control.

7.2.5 Run the VI

1. Run the VI.
2. Use the Operating tool to click the vertical switch to stop the acquisition. The switch changes to the OFF position and changes back to ON after the conditional terminal reads the value.
3. Save the VI. You will use this VI in the Temperature Running Average (Section 7.3) VI.

7.3 Temperature Running Average VI

Exercise 7.2:

Complete the following steps to modify the Temperature Monitor VI to average the last three temperature measurements and display the average on a waveform chart.

7.3.1 Front Panel

1. Open the Temperature Monitor (Section 7.2) VI.
2. Select File>>Save As and rename the VI Temperature Running Average.vi in the C:\Exercises\LabVIEW Basics I directory.

7.3.2 Block Diagram

1. Display the block diagram.
2. Right-click the right or left border of the While Loop and select Add Shift Register from the shortcut menu to create a shift register.
3. Right-click the left terminal of the shift register and select Add Element from the shortcut menu to add an element to the shift register.
4. Modify the block diagram as in Figure 7.10.

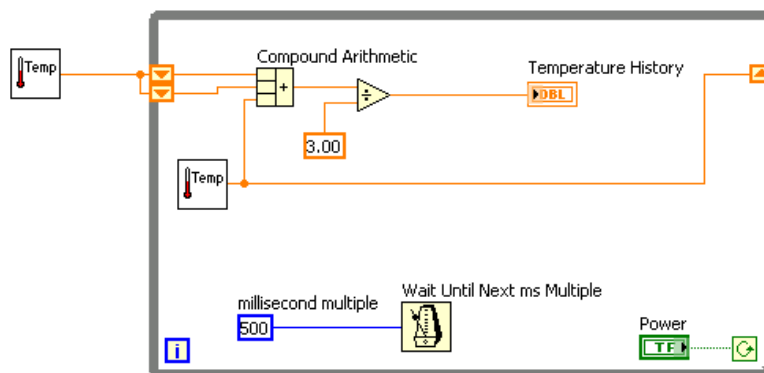





Figure 7.10

- (a)  Press the <Ctrl> key while you click the Thermometer VI and drag it outside the While Loop to create a copy of the subVI. The Thermometer VI returns one temperature measurement from the temperature sensor and initializes the left shift registers before the loop starts.
- (b)  Place the Compound Arithmetic function, located on the Functions>>Arithmetic & Comparison>>Express Numeric palette, on the block diagram. This function returns the sum of the current temperature and the two previous temperature readings. Use the Positioning tool to resize the function to have three left terminals.
- (c)  Place the Divide function, located on the Functions>>Arithmetic & Comparison>>Express Numeric palette, on the block diagram. This function returns the average of the last three temperature readings.
- (d)  Right-click the y terminal of the Divide function, select Create>>Constant, type 3, and press the <Enter> key.

7.3.3 Run the VI

1. Run the VI. During each iteration of the While Loop, the Thermometer VI takes one temperature measurement. The VI adds this value to the last two measurements stored in the left terminals of the shift register. The VI divides the result by three to find the average of the three measurements, the current measurement plus the previous two. The VI displays the average on the waveform chart. Notice that the VI initializes the shift register with a temperature measurement.

7.3.4 Block Diagram

1. Modify the block diagram as shown in Figure 7.11.

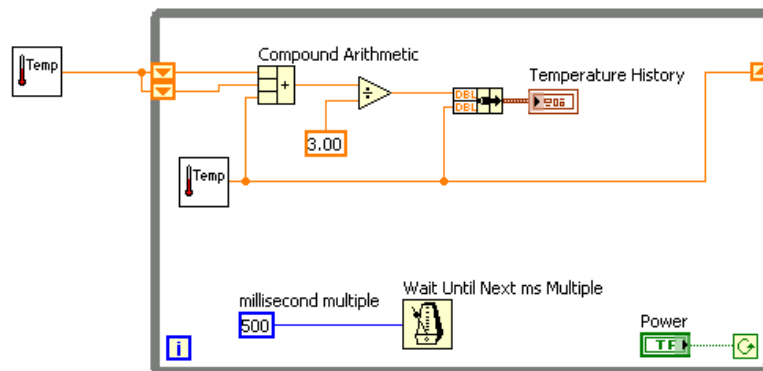



Figure 7.11

- (a)  Place the Bundle function, located on the Functions»All Functions»Cluster palette, on the block diagram. This function bundles the average and current temperature for plotting on the waveform chart.

2. Save the VI. You will use this VI later in the course.

7.3.5 Run the VI

1. Run the VI. The VI displays two plots on the waveform chart. The plots are overlaid. That is, they share the same vertical scale.
2. If time permits, complete the optional steps. Otherwise, close the VI.

7.3.6 Optional

Customize the waveform chart as shown in Figure 7.12. You can display a plot legend, a scale legend, a graph palette, a digital display, and a scrollbar. By default, a waveform chart displays the plot legend.

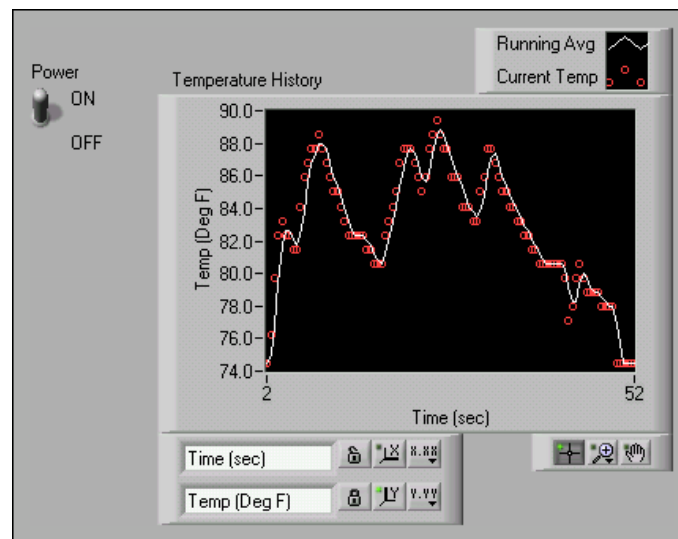



Figure 7.12

1. Customize the y-axis.

- (a)  Use the Labeling tool to double-click 70.0 in the y-axis, type 75.0, and press the <Enter> key.

- (b)**b** - Use the Labeling tool to double-click the second number from the bottom on the y-axis, type 80.0, and press the <Enter> key. This number determines the numerical spacing of the y-axis divisions. For example, if the number above 75.0 is 77.5, it indicates a y-axis division of 2.5, changing the 77.5 to 80.0 reformats the y-axis to multiples of 5.0 (75.0, 80.0, 85.0, and so on).

NOTE: The waveform chart size has a direct effect on the display of axis scales. Increase the waveform chart size if you encounter problems while customizing the axis.

2. Right-click the waveform chart and select Visible Items>>Scale Legend from the shortcut menu to display the scale legend, as shown in Figure 7.13. You can place the scale legend anywhere on the front panel.



Figure 7.13: 1. X-axis, 2. Y-axis, 3. Scale Labels, 4. Scale Lock Button, 5. Autoscale Button, 6. Scale Format Button

3. Use the scale legend to customize each axis.
- Make sure the Lock Autoscale button appears locked and the Autoscale LED is green so the y-axis adjusts the minimum and maximum values to fit the data in the chart.
 - Click the Scale Format button to change the format, precision, mapping mode, scale visibility, and grid options for each axis.
4. Use the plot legend to customize the plots.
- Use the Positioning tool to resize the plot legend to include two plots.
 - Use the Labeling tool to change Temp to Running Avg and to change Plot 1 to Current Temp. If the text does not fit, use the Positioning tool to resize the plot legend.
 - Right-click the plot in the plot legend to set the line and point styles and the color of the plot background or traces.
5. Right-click the waveform chart and select Visible Items>>Graph Palette from the shortcut menu to display the graph palette, as shown in Figure 7.14. You can place the graph palette anywhere on the front panel.

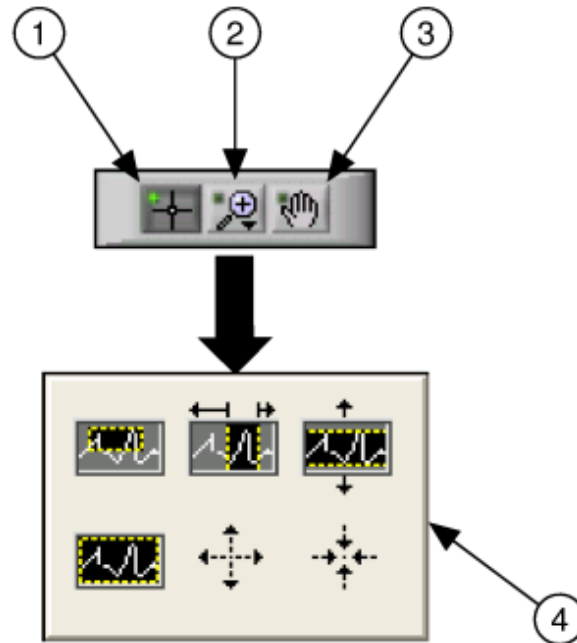

Figure 7.14: 1. Cursor Movement Tool, 2. Zoom Button, 3. Panning Tool, 4. Zoom Pull-down Menu

Use the Zoom button on the graph palette to zoom in or out of sections of the chart or the whole chart. Use the Panning tool to pick up the plot and move it around on the display. Use the Cursor Movement tool to move the cursor on the graph.

6. Run the VI. While the VI runs, use the buttons in the scale legend and graph palette to modify the waveform chart.

NOTE: If you modify the axis labels, the display might become larger than the maximum size that the VI can correctly present.

7. Use the Operating tool to click the Power switch and stop the VI.

8. Save and close the VI.

7.4 Waveform and XY Graphs

VIs with graphs usually collect the data in an array and then plot the data to the graph. Figure 7.15 shows the elements of a graph.

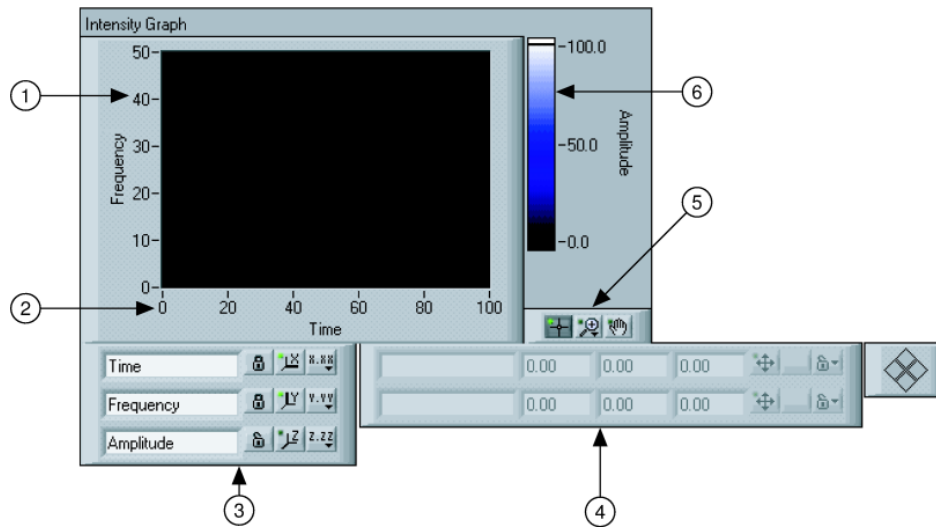

Figure 7.15

The graphs located on the Controls \gg Graph Indicators palette include the waveform graph and XY graph. The waveform graph plots only single-valued functions, as in $y = f(x)$, with points evenly distributed along the x-axis, such as acquired time-varying waveforms. XY graphs display any set of points, evenly sampled or not.

Resize the plot legend to display multiple plots. Use multiple plots to save space on the front panel and to make comparisons between plots. XY and waveform graphs automatically adapt to multiple plots.

7.4.1 Single Plot Waveform Graphs

The waveform graph accepts a single array of values and interprets the data as points on the graph and increments the x index by one starting at $x = 0$. The graph also accepts a cluster of an initial x value, a Δx , and an array of y data. Refer to the Waveform Graph VI in the NI Example Finder for examples of the data types that single-plot waveform graphs accept.

7.4.2 Multiplot Waveform Graphs

A multiplot waveform graph accepts a 2D array of values, where each row of the array is a single plot. The graph interprets the data as points on the graph and increments the x index by one, starting at $x = 0$. Wire a 2D array data type to the graph, right-click the graph, and select Transpose Array from the shortcut menu to handle each column of the array as a plot. Refer to the (Y) Multi Plot 1 graph in the Waveform Graph VI in the NI Example Finder for an example of a graph that accepts this data type.

A multiplot waveform graph also accepts a cluster of an x value, a Δx value, and a 2D array of y data. The graph interprets the y data as points on the graph and increments the x index by Δx , starting at $x = 0$. Refer to the (Xo, dX, Y) Multi Plot 3 graph in the Waveform Graph VI in the NI Example Finder for an example of a graph that accepts this data type.

A multiplot waveform graph accepts a cluster of an initial x value, a Δx value, and an array that contains clusters. Each cluster contains a point array that contains the y data. You use the

Bundle function to bundle the arrays into clusters, and you use the Build Array function to build the resulting clusters into an array. You also can use the Build Cluster Array, which creates arrays of clusters that contain inputs you specify. Refer to the (Xo, dX, Y) Multi Plot 2 graph in the Waveform Graph VI in the NI Example Finder for an example of a graph that accepts this data type.

7.4.3 Single Plot XY Graphs

The single-plot XY graph accepts a cluster that contains an x array and a y array. The XY graph also accepts an array of points, where a point is a cluster that contains an x value and a y value. Refer to the XY Graph VI in the NI Example Finder for an example of single-plot XY graph data types.

7.4.4 Multiplot XY Graphs

The multiplot XY graph accepts an array of plots, where a plot is a cluster that contains an x array and a y array. The multiplot XY graph also accepts an array of clusters of plots, where a plot is an array of points. A point is a cluster that contains an x value and a y value. Refer to the XY Graph VI in the NI Example Finder for an example of multiplot XY graph data types.

7.5 Graph Waveform Array VI

Exercise 7.3:

Complete the following steps to build a VI that generates and plots an array on a waveform graph and modify the VI to graph multiple plots.

7.5.1 Front Panel

1. Open a blank VI and build the front panel shown in Figure 7.16.

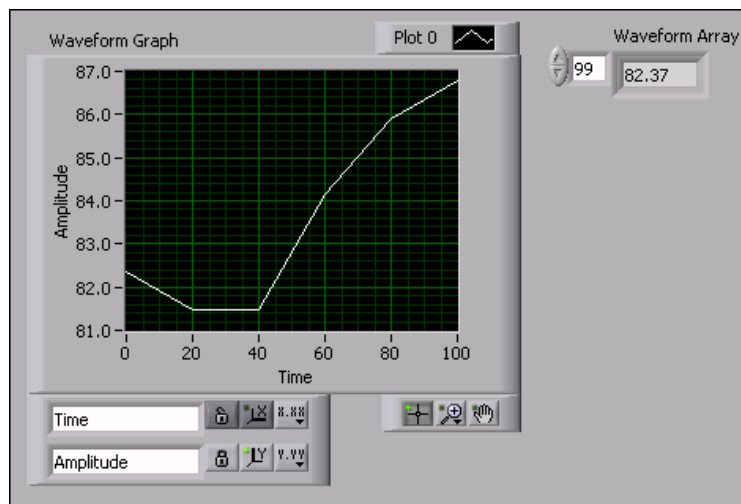

Figure 7.16

- (a) Place an array, located on the Controls»All Controls»Array & Cluster palette, on the front panel.
- (b) Label the array Waveform Array.
- (c) Place a numeric indicator, located on the Controls»Numeric Indicators palette, in the array shell.
- (d) Place a waveform graph, located on the Controls»Graph Indicators palette, on the front panel.

7.5.2 Block Diagram

1. Build the block diagram shown in Figure 7.17.

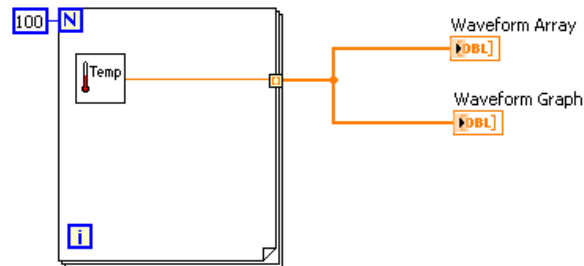



Figure 7.17

- (a)  Place the Thermometer VI on the block diagram. Select Functions»All Functions»Select a VI and navigate to C:\Exercises\ LabVIEW Basics I\Thermometer.vi. This subVI returns one temperature reading during each For Loop iteration.

NOTE: Use the (Demo) Thermometer VI if you do not have a DAQ device available.

- (b)  Place a For Loop, located on the Functions»All Functions»Structures palette, on the block diagram. In this exercise, each For Loop iteration generates a temperature value and stores it in the indexed tunnel. Create a constant of 100 for the count terminal.
- (c) Wire the block diagram as shown in Figure 7.17.

NOTE: When you wire data to charts and graphs, refer to the Context Help window for more information about wiring the objects, including whether to use a Build Array or Bundle function, the order of the input terminals, and so on. In general, use a waveform chart for single scalar points, a waveform graph for an array of y values, and an XY graph for an array of x values and an array of y values. For example, if you move the cursor over a waveform graph terminal on the block diagram, the information shown in Figure 7.18 appears in the Context Help window. Select Help»Find Examples to launch the NI Example Finder, double-click Fundamentals, double-click Graphs and Charts, and

double-click the Waveform Graph VI to open the example. Refer to the lesson on Data Acquisition and Waveforms for more information about the waveform data type.

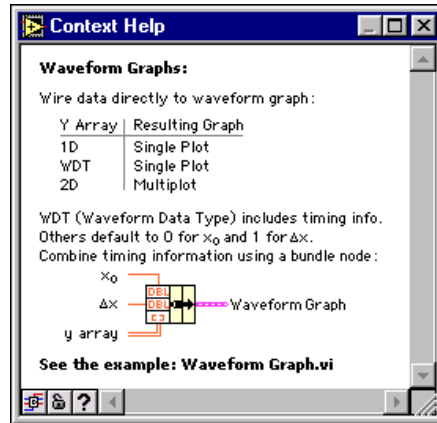

Figure 7.18

2. Save the VI as Graph Waveform Array.vi in the C:\Exercises\LabVIEW Basics I directory.

7.5.3 Run the VI

1. Display the front panel and run the VI. The VI plots the auto-indexed waveform array on the waveform graph.
2. Enter the index of any element in the Waveform Array index display to view the value of that element. If you enter a number greater than the array size of 100, the display dims.
3. Use the Positioning tool to resize Waveform Array to view more than one element. The indicator displays elements in ascending index order, beginning with the index you entered.

7.5.4 Block Diagram

In this block diagram, you use the default value of the initial x and Δx value for the waveform. In cases where the initial x and Δx value are a specific value, use the Bundle function to specify an initial x and Δx value for a waveform array.

1. Modify the block diagram as shown in Figure 7.19.

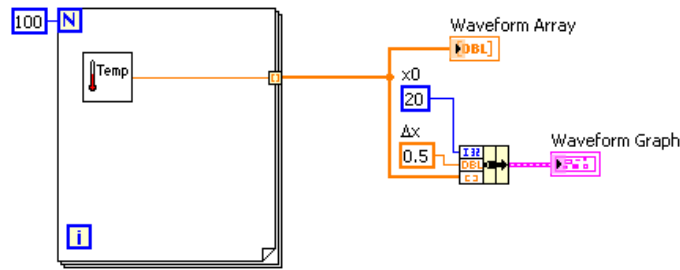

Figure 7.19



- (a) Place the Bundle function, located on the Functions»All Functions»Cluster palette, on the block diagram. This function assembles the plot elements into a single cluster. The elements include the initial x value (20), the Δx value (0.5), and the y array of waveform data.
- (b) Create two numeric constants for the initial x value and Δx value.
- (c) Label the Δx constant by typing Dx. Use the Labeling tool to select the D and select the Symbol font from the Text Settings pull-down menu on the toolbar. D converts to the delta symbol (Δ).
- (d) Wire the block diagram as shown in Figure 7.19.

2. Save the VI.

7.5.5 Run the VI

1. Display the front panel and run the VI. The graph displays the same 100 points of data with a starting value of 20 and a Δx of 0.5 for each point on the x-axis. In a timed test, this graph would correspond to 50 seconds worth of data starting at 20 seconds.

NOTE: Change the initial x and Δx values in only one location, either the Bundle function or in the Waveform Graph Properties dialog box.

2. If time permits, complete the optional steps. Otherwise, close the VI.

7.5.6 Optional

1. Right-click the waveform graph and select Visible Items»Graph Palette from the shortcut menu to display the graph palette. Click the Zoom button to see the data on the graph in more detail.
2. Right-click the graph and select Visible Items»Scale Legend from the shortcut menu to display the scale legend.
3. Return to the block diagram. Create a multiple-plot waveform graph by building a 2D array of the data type normally passed to a single-plot graph. Modify the block diagram as shown in Figure 7.20.

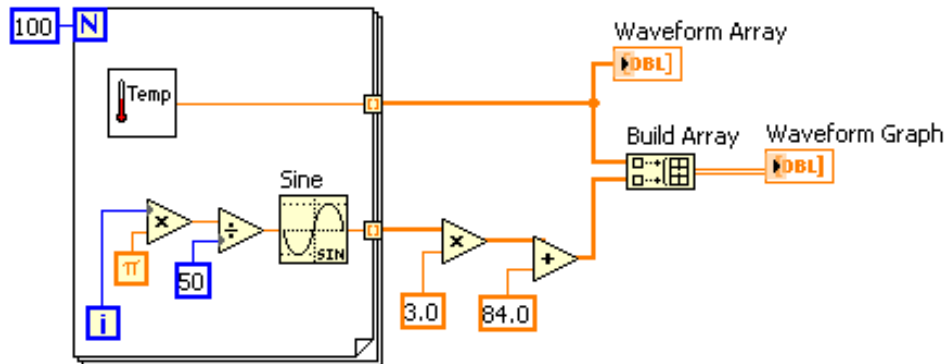





Figure 7.20

- (a)  Place the Sine function, located on the Functions»Arithmetic & Comparison»Express Numeric»Express Trigonometric palette, on the block diagram. Use this function to build an array of points that represents one cycle of a sine wave.
- (b)  Place the Build Array function, located on the Functions»All Functions»Array palette, on the block diagram. This function creates the data structure to plot two arrays on a waveform graph.
- (c)  Place the pi constant, located on the Functions»Arithmetic & Comparison»Express Numeric»Express Numeric Constants palette, on the block diagram.
- (d) Wire the block diagram as shown Figure 7.20.

4. Save the VI.
5. Display the front panel and run the VI. The two waveforms plot on the same waveform graph.
6. Display the block diagram.
7. Right-click the wire to Waveform Array, select Custom Probes»Controls»Graph Indicators from the shortcut menu, and select a waveform graph to place a graph probe on the wire.
8. Display the front panel and run the VI. The probe shows only the data array. The sine wave is not present because you did not place the probe on the wire to which the sine wave is bundled.
9. Close the Probe window.
10. Zoom in on a portion of the graph.

- (a)  Click the Zoom button on the graph palette, shown in pg 131, to display the Zoom pull-down menu.
- (b) Select Zoom by X Rectangle, as shown in Figure 7.21.

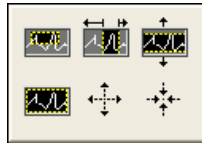





Figure 7.21

- (c) Click and drag a selection rectangle on the graph. When you release the mouse button, the graph display zooms in on the selected area.
 - (d) You also can select Zoom by Y Rectangle or Zoom by Selected Area. Experiment with these options.
 - (e)   Select Undo Zoom from the lower left corner of the pull-down menu to undo a zoom or click the x-axis single fit button and the y-axis single fit button on the scale legend, shown in pg 132 and pg 132.
11.  Use the Panning tool, shown in pg 132, to click and drag the graph display. Click the x-axis and y-axis single fit buttons again to restore the display to its original position.
 12.  Use the Cursor Movement tool, shown in pg 132, to return the cursor to standard mode.
 13. Save and close the VI.

7.6 Temperature Analysis VI

Exercise 7.4:

Complete the following steps to build a VI that measures temperature every 0.25 seconds for 10 seconds. During the acquisition, the VI displays the measurements in real time on a waveform chart. After the acquisition is complete, the VI plots the data on a graph and calculates the minimum, maximum, and average temperatures. The VI displays the best fit of the temperature graph.

7.6.1 Front Panel

1. Open a blank VI and build the front panel shown in Figure 7.22.

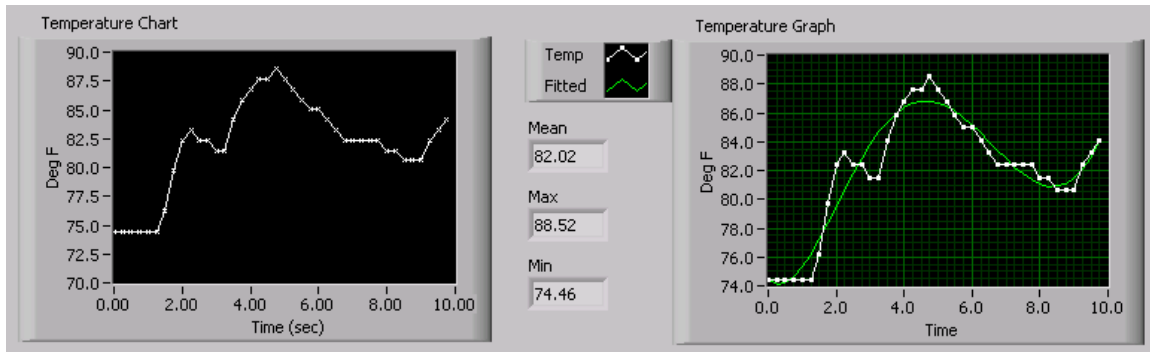

Figure 7.22

- Set the point style of the waveform chart plot to a small x .
- Hide the plot legend of the waveform chart.
- Change the label of the waveform chart to Temperature Chart.
- Change the label of the waveform graph to Temperature Graph.
- Right-click Temperature Chart and select Properties from the shortcut menu. On the Scales tab, change the x-axis multiplier to 0.25. On the Format and Precision tab, change the Digits of Precision to 2. The data for Temperature Graph will be formatted on the block diagram.
- Resize the plot legend of the waveform graph to show two plots.
- Change the name of Plot 0 to Temp and Plot 1 to Fitted.
- Set the point style of the waveform graph Temp plot to a small square.
- Do not create the Mean, Max, and Min indicators yet. They will be created from the block diagram.

7.6.2 Block Diagram

- Build the block diagram Figure 7.23.

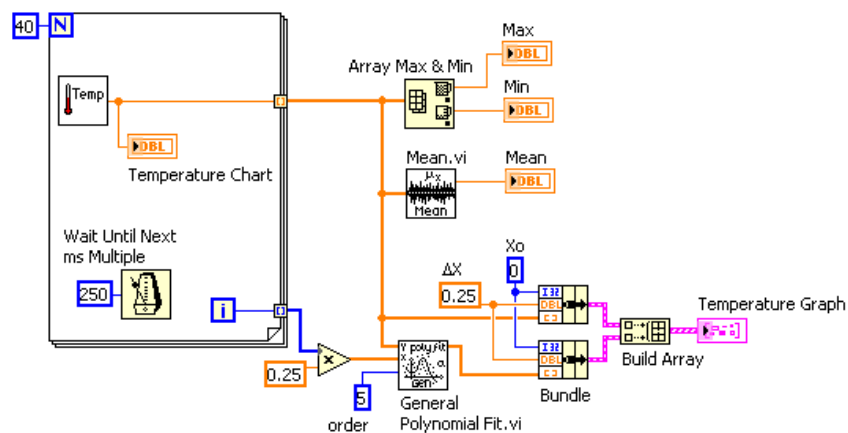









Figure 7.23

- (a)  Place the Thermometer VI on the block diagram. Select Functions»All Functions»Select a VI and navigate to C:\Exercises\LabVIEW Basics I\Thermometer.vi. This subVI returns one point of temperature data.
- (b)  Place the Wait Until Next ms Multiple function, located on the Functions»All Functions»Time & Dialog palette, on the block diagram. This function causes the For Loop to execute every 0.25seconds (250ms).
- (c)  Place the Array Max & Min function, located on the Functions»All Functions»Array palette, on the block diagram. This function returns the maximum and minimum temperature.
- (d)  Place the Mean VI, located on the Functions»All Functions»Analyze»Mathematics»Probability and Statistics palette, on the block diagram. This subVI returns the average of the temperature measurements.
- (e) Right-click the output terminals of the Array Max & Min function and Mean VI and select Create»Indicator from the shortcut menu to create the Max, Min, and Mean indicators.
- (f)  Place the General Polynomial Fit VI, located on the Functions»All Functions»Analyze»Mathematics»Curve Fitting palette, on the block diagram. This subVI returns an array that is a polynomial fit to the temperature array.
- (g)  Place the Bundle function, located on the Functions»All Functions»Cluster palette, on the block diagram. This function assembles the plot elements into a single cluster. Press the <Ctrl> key while you drag the function to copy it. The elements include the initial x value (0), the Δx value (0.25), and the y array of temperature data. The Δx value of 0.25 is required so that the VI plots the temperature array points every 0.25 seconds on the waveform graph.
- (h)  Place the Build Array function, located on the Functions»All Functions»Array palette, on the block diagram. This function creates an array of clusters from the temperature cluster and the best fit cluster.
- (i) Complete the block diagram as shown.

2. Save the VI as Temperature Analysis.vi in the C:\Exercises\LabVIEW Basics I directory.

7.6.3 Run the VI

1. Display the front panel and run the VI. The graph displays both the temperature data and best fit curve of the temperature waveform.

2. Try different values for the polynomial order constant on the block diagram and run the VI again.
3. Change the appearance of the plots by modifying the plot styles and fill styles.
 - (a) Right-click the Temp plot display in the plot legend and select Common Plots»Scatter Plot from the shortcut menu, the top middle option.
 - (b) Right-click the Fitted plot display in the plot legend, select Bar Plots from the shortcut menu, and select the second option in the middle row. The waveform graph should appear similar to the front panel in Figure 7.24.

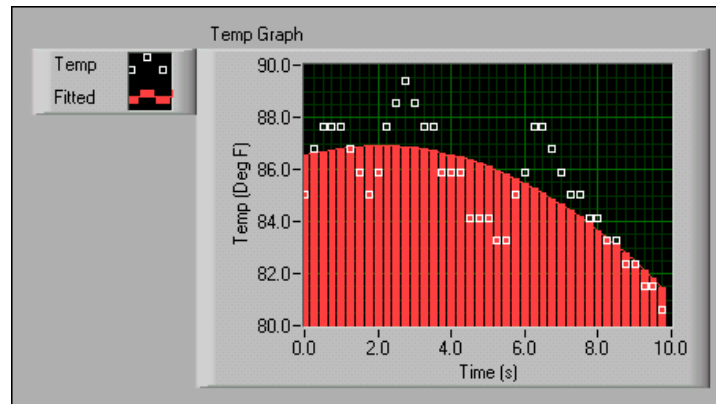

Figure 7.24

4. Save and close the VI.

7.7 Graph Circle VI

Exercise 7.5:

Complete the following steps to build a VI that plots a circle using independent x and y arrays.

7.7.1 Front Panel

1. Open a blank VI and build the front panel shown in Figure 7.25.

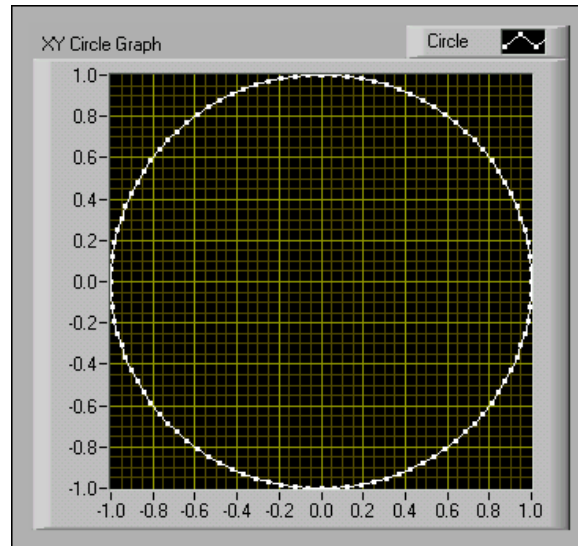

Figure 7.25

- (a) Place an XY Graph, located on the Controls \gg All Controls \gg Graph palette, on the front panel.
- (b) Label the graph XY Circle Graph.
- (c) Change Plot 0 to Circle in the plot legend.
- (d) Right-click the plot in the plot legend, select Point Style from the shortcut menu, and select the small square.
- (e) Change the scale labels and ranges, as shown in Figure 7.25.

7.7.2 Block Diagram

1. Build the block diagram shown in Figure 7.26.

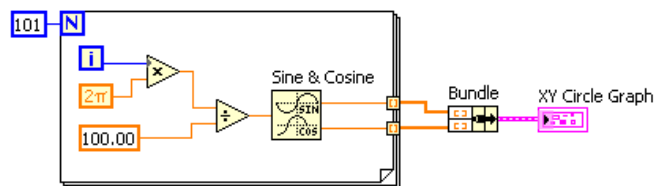



Figure 7.26



- (a) Place the Sine & Cosine function, located on the Functions \gg Arithmetic & Comparison \gg Express Numeric \gg Express Trigonometric palette, on the block diagram. This function builds an array of points that represents one cycle of a sine wave and a cosine wave.

- (b)  Place the Bundle function, located on the Functions»All Functions»Cluster palette, on the block diagram. This function assembles the sine array and the cosine array to plot the sine array against the cosine array to produce a circle.
- (c)  Place the Pi Multiplied by 2 constant, located on the Functions»Arithmetic & Comparison»Express Numeric»Express Numeric Constants palette, on the block diagram.

2. Save the VI as Graph Circle.vi in the C:\Exercises\LabVIEW Basics I directory.
3. Display the front panel and run the VI.
4. Close the VI.

7.8 Intensity Plots

You can use intensity graphs and charts to display patterned data, such as temperature patterns and topographical terrain, where the magnitude represents altitude. Like the waveform graph and chart, the intensity graph features a fixed display while the intensity chart features a scrolling display. The intensity graph and chart accept a 2D array of numbers. Each number in the array represents a specific color. The indexes of the elements in the 2D array set the plot locations for the colors. The intensity graph or chart can display up to 256 discrete colors.

Figure 7.27 shows a 4×3 array plotted on an intensity graph. The graph transposes the array elements.

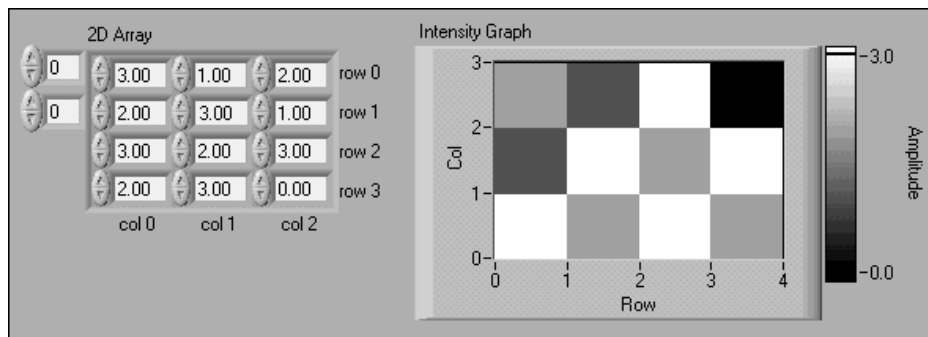

Figure 7.27

7.8.1 Intensity Graph and Chart Options

The intensity graphs and charts share many of the optional parts of the waveform graphs and charts, which you can show or hide by right-clicking the graph or chart and selecting Visible Items from the shortcut menu. In addition, because the intensity graphs and charts include color as a third dimension, a scale similar to a color ramp control defines the range and mappings of values to colors. Figure 7.28 shows the elements of an intensity graph.

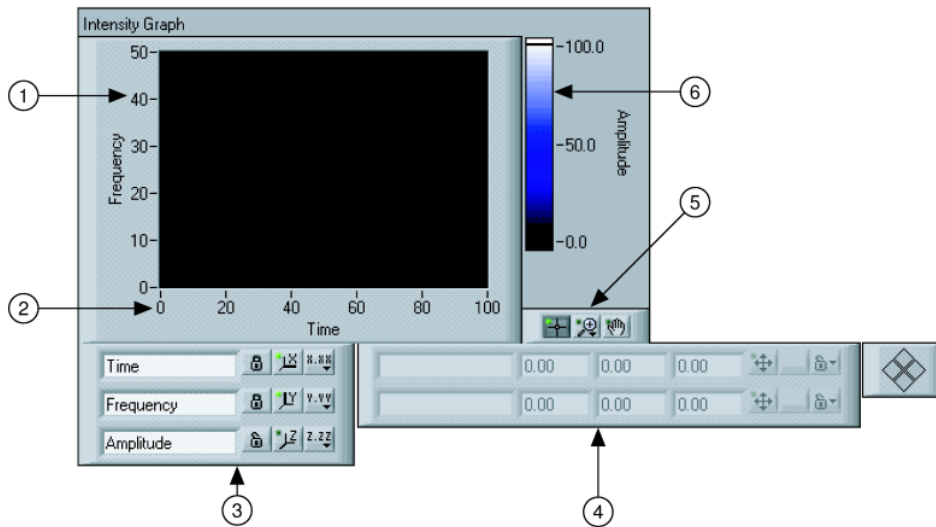

Figure 7.28

Use the Operating or Positioning tools to right-click the marker next to the color ramp, select Marker Color from the shortcut menu to change the color associated with a marker, and select the color you want from the color picker that appears. To add markers to a color ramp, right-click the color ramp and select Add Marker from the shortcut menu. To change the value of an arbitrary marker on a color ramp, use the Operating tool to drag the marker to the value you want or use the Labeling tool to highlight the text of the marker and enter a new value.

7.9 Intensity Graph Example VI

Exercise 7.6:

In this exercise, you use a VI that displays a wave interference pattern on an intensity graph. You also use the VI to plot a 2D array of data on the graph.

7.9.1 Front Panel

1. Open and run the Intensity Graph Example (Figure 7.29) VI located in the C:\Exercises\LabVIEW Basics I directory. By default, the VI plots an interference waveform. A Property Node on the block diagram defines the color range used in the intensity graph. You can change the color range by opening the block diagram and modifying the Color Array constant.

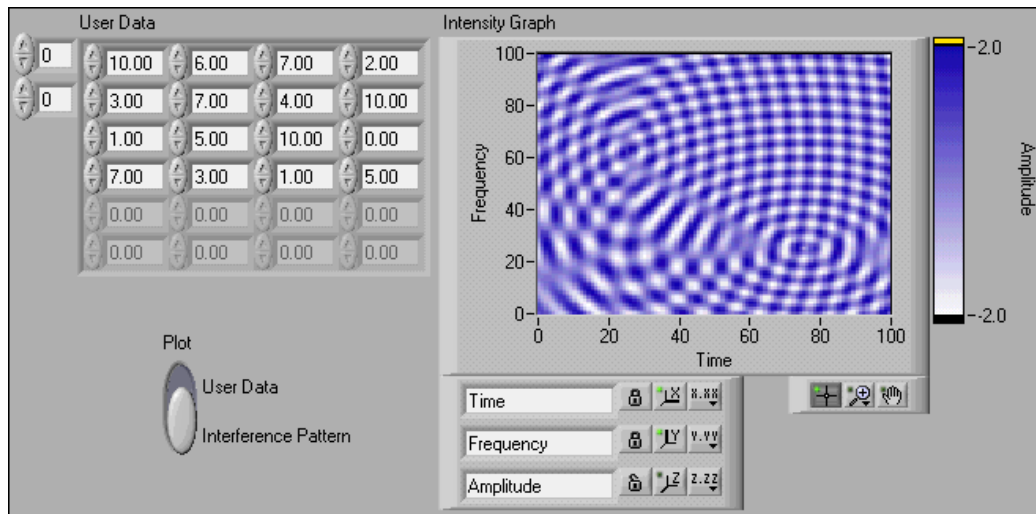

Figure 7.29

2. Change the Plot switch on the front panel to User Data and enter values between 0.0 and 10.0 in the User Data array control. Run the VI. Notice how the magnitude of each element is mapped to the intensity graph.

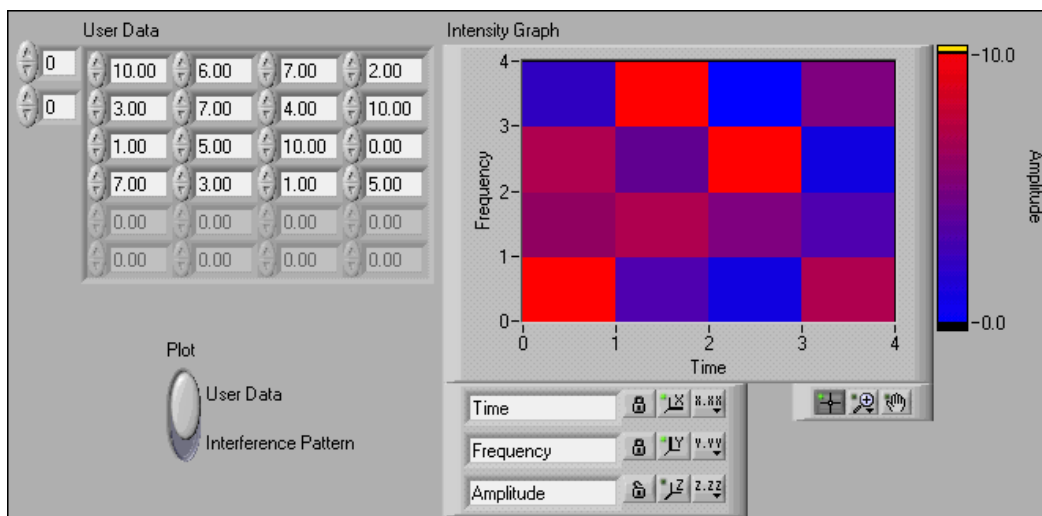

Figure 7.30

3. Close the VI. Do not save changes.

7.10 Summary, Tips, and Tricks on Plotting Data

- The waveform chart is a special numeric indicator that displays one or more plots.
- The waveform chart has the following three update modes:

- A strip chart shows running data continuously scrolling from left to right across the chart.
 - A scope chart shows one item of data, such as a pulse or wave, scrolling partway across the chart from left to the right.
 - A sweep display is similar to an EKG display. A sweep works similarly to a scope except it shows the old data on the right and the new data on the left separated by a vertical line.
- Waveform graphs and XY graphs display data from arrays.
 - Right-click a waveform chart or graph or its components to set attributes of the chart and its plots.
 - You can display more than one plot on a graph using the Build Array function located on the Functions»All Functions»Array palette and the Bundle function located on the Functions»All Functions»Cluster palette for charts and XY graphs. The graph becomes a multiplot graph when you wire the array of outputs to the terminal.
 - You can use intensity charts and graphs to plot three-dimensional data. The third dimension is represented by different colors corresponding to a color mapping that you define. Intensity charts and graphs are commonly used in conjunction with spectrum analysis, temperature display, and image processing.
 - When you wire data to charts and graphs, use the Context Help window to determine how to wire them.

7.11 Additional Exercises for Plotting Data

Exercise 7.7:

Build a VI that displays two plots, a random plot and a running average of the last four points, on a waveform chart in sweep update mode. Use the following tips:

- Use a For Loop ($n = 200$) instead of a While Loop.
- Use a shift register with three left terminals to average the last four data points.
- Use the Random Number (0-1) function located on the Functions»Arithmetic & Comparison»Express Numeric palette to generate the data.
- Use the Bundle function located on the Functions»All Functions»Cluster palette to group the random data with the averaged data before plotting.

Save the VI as Random Average.vi in the C:\Exercises\LabVIEW Basics I directory.

Exercise 7.8:

Build a VI that continuously measures the temperature once per second and displays the temperature on a scope chart. If the temperature goes above or below limits specified with front panel controls, the VI turns on a front panel LED. The chart plots the temperature and the upper and lower temperature limits. You should be able to set the limit from the following front panel.

Save the VI as Temperature Limit.vi in the C:\Exercises\LabVIEW Basics I directory.

Exercise 7.9:

Modify the VI you created in Exercise 7.8 to display the maximum and minimum values of the temperature trace.

TIP: Use shift registers and two Max & Min functions located on the Functions»All Functions»Comparison palette.

Select File»Save As to save the VI as Temp Limit (max-min).vi in the C:\Exercises\LabVIEW Basics I directory.

Chapter 8

Making Decisions in a VI

8.1 Making Decisions with the Select Function

Every VI described in this course so far has executed in an order dependent on the flow of data. There are cases when a decision must be made in a program. For example, if *a* happens, do *b*; else if *c* happens, do *d*.

In text-based programs, this can be accomplished with if-else statements, case statements, switch statements, and so on. LabVIEW includes many different ways of making decisions. The simplest of these methods is the Select function.

8.1.1 Select Function



The Select function, located on the Functions»Express Comparison palette, selects between two values dependent on a Boolean input. If the Boolean input *s* is True, this function returns the value wired to the *t* input. If the Boolean input is False, this function returns the value wired to the *f* input.

You used the Select function in the Thermometer VI (Section 3.5) exercise to determine whether to output a Fahrenheit value or a Celsius value, as shown in the block diagram in Figure 8.1.

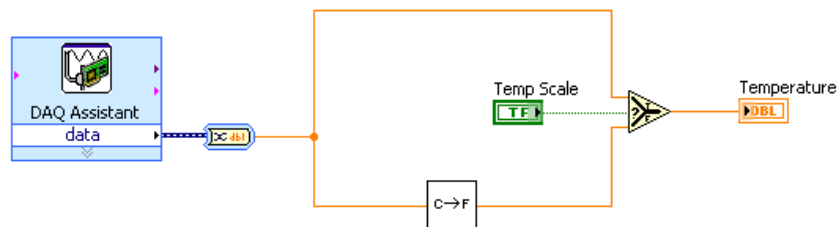
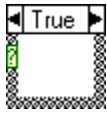

Figure 8.1

If the decision to be made is more complex than a Select function can execute, a Case structure may be required.

8.2 Case Structures



A Case structure has two or more subdiagrams, or cases. Only one subdiagram is visible at a time, and the structure executes only one case at a time. An input value determines which subdiagram executes. The Case structure is similar to case statements or if...then...else statements in text-based programming languages.

The case selector identifier at the top of the Case structure contains the case selector identifier in the center and decrement and increment buttons on each side. Use the decrement and increment buttons to scroll through the available cases.

Wire an input value, or selector, to the selector terminal to determine which case executes. You must wire an integer, Boolean value, string, or enumerated type value to the selector terminal. You can position the selector terminal anywhere on the left border of the Case structure. If you wire a Boolean to the selector terminal, the structure has a True case and a False case. If you wire an integer, string, or enumerated type value to the selector terminal, the structure can have up to $2^{31} - 1$ cases.

You can specify a default case for the Case structure. You must specify a default case to handle out-of-range values or explicitly list every possible input value. For example, if you specified cases for 1, 2, and 3 but you get an input of 4, the Case structure executes the default case.

You can specify a default case for the Case structure. You must specify a default case to handle out-of-range values or explicitly list every possible input value. For example, if you specified cases for 1, 2, and 3 but you get an input of 4, the Case structure executes the default case.

Right-click the Case structure border to add, duplicate, remove, or rearrange cases and to select a default case.

8.2.1 Selecting a Case

The block diagram in Figure 8.2 is an example of the Thermometer VI (Section 3.5) that uses a Case structure instead of the Select function. It is shown with the True case foremost in the Case structure.

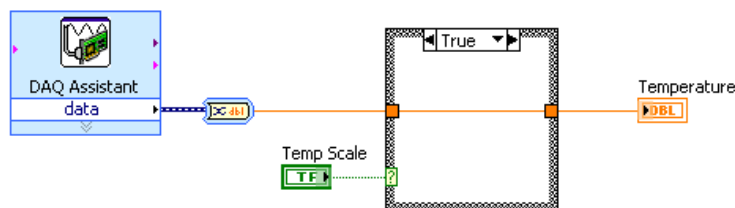

Figure 8.2

To select a case, type the value in the case selector identifier or use the Labeling tool to edit the values, as shown in the block diagram in Figure 8.3.

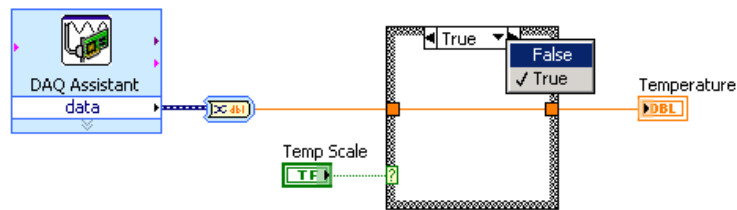

Figure 8.3

Once you have selected another case, that case appears foremost, as shown in the block diagram in Figure 8.4.

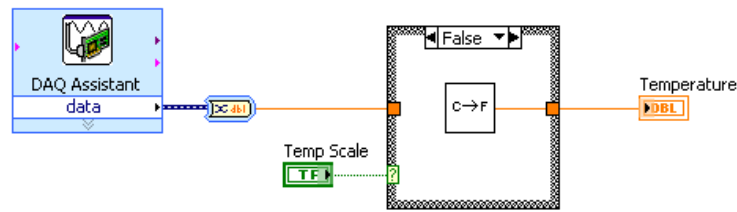

Figure 8.4

If you enter a selector value that is not the same type as the object wired to the selector terminal, the value appears red to indicate that you must delete or edit the value before the structure can execute, and the VI will not run. Also, because of the possible round-off error inherent in floating-point arithmetic, you cannot use floating-point numeric values as case selector values. If you wire a floating-point value to the case, LabVIEW rounds the value to the nearest even integer. If you type a floating-point value in the case selector, the value appears red to indicate that you must delete or edit the value before the structure can execute.

8.2.2 Input and Output Tunnels

You can create multiple input and output tunnels for a Case structure. Inputs are available to all subdiagrams, but subdiagrams do not need to use each input. When you create an output tunnel in one case, corresponding tunnels appear at the same position on the border in all other cases.

If at least one output tunnel is not defined, all output tunnels on the structure appear as white squares. Wire to the output tunnel for each unwired case, clicking the tunnel each time. You can define a different data source for the same output tunnel in each case, but the data types must be compatible. You also can wire constants or controls to unwired cases by right-clicking the tunnel and selecting **Create»Constant** or **Create»Control** from the shortcut menu.

NOTE: You can right-click the output tunnel and select **Use Default If Unwired** from the shortcut menu to use the default value for the tunnel data type for all unwired tunnels.

8.2.3 Examples

In the following examples, the numeric values pass through tunnels to the Case structure and are either added or subtracted, depending on the value wired to the selector terminal.

Example 8.1: Boolean Case Structure

The example in Figure 8.5 is a Boolean Case structure. The cases are shown overlapped to simplify the illustration.

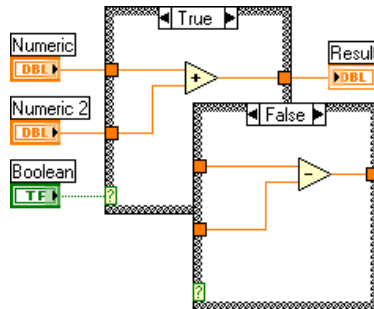

Figure 8.5

If the Boolean control wired to the selector terminal is True, the VI adds the numeric values. Otherwise, the VI subtracts the numeric values.

Example 8.2: Integer Case Structure

The example in Figure 8.6 is an integer Case structure.

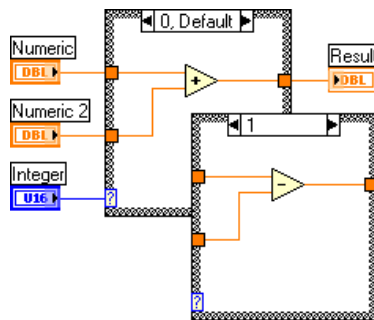

Figure 8.6

Integer is a text ring control located on the Controls»Text Controls palette that associates numeric values with text items. If the text ring control wired to the selector terminal is 0 (add), the VI adds the numeric values. If the value is 1 (subtract), the VI subtracts the numeric values. If the text ring control is any other value than 0 (add) or 1 (subtract), the VI adds the numeric values, because that is the default case.

Example 8.3: String Case Structure

The example in Figure 8.7 is a string Case structure.

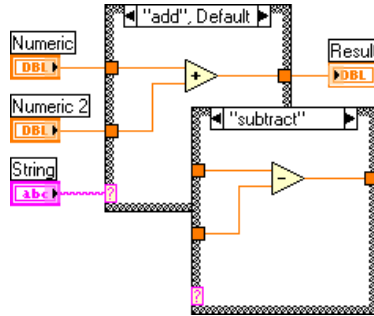

Figure 8.7

If String is add, the VI adds the numeric values. If String is subtract, the VI subtracts the numeric values.

Example 8.4: Enumerated Case Structure

The example in Figure 8.8 is an enumerated Case structure.

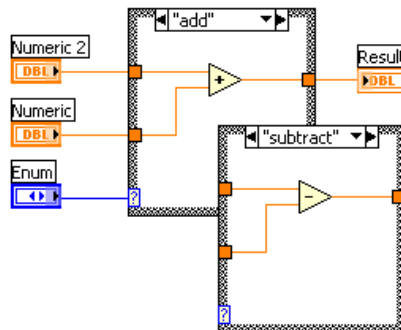

Figure 8.8

An enumerated control gives users a list of items from which to select. The data type of an enumerated control includes information about the numeric values and string labels in the control. When you wire an enumerated control to the selector terminal of a Case structure, the case selector displays a case for each item in the enumerated control. The Case structure executes the appropriate case subdiagram based on the current item in the enumerated control. In the block diagram (Figure 8.8), if Enum is add, the VI adds the numeric values. If Enum is subtract, the VI subtracts the numeric values.

Example 8.5: Error Case Structure

The example in Figure 8.9 is an error cluster Case structure.

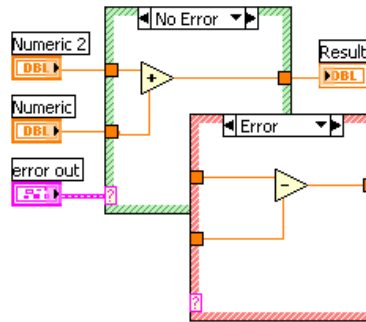

Figure 8.9

When you wire an error cluster to the selector terminal of a Case structure, the case selector label displays two cases, Error and No Error, and the border of the Case structure changes color—red for Error and green for No Error. The Case structure executes the appropriate case subdiagram based on the error state.

When an error cluster is wired to the selection terminal, the Case structure recognizes only the status Boolean of the cluster.

8.3 Square Root VI

Exercise 8.1:

8.3.1 Front Panel

1. Open a blank VI and build the front panel shown in Figure 8.10.



Figure 8.10

8.3.2 Block Diagram

1. Build the block diagram shown in Figure 8.11.

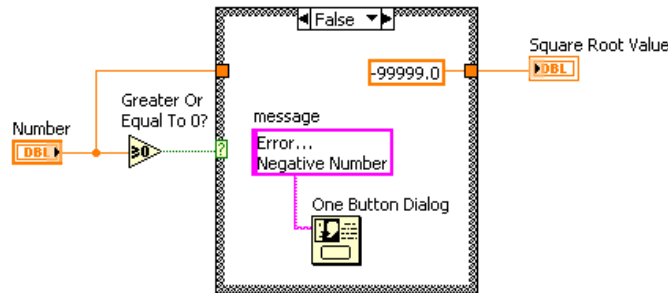
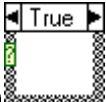



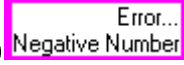



Figure 8.11

- (a)  Place the Case structure, located on the Functions»Execution Control palette, on the block diagram. Click the decrement or increment button to select the False case.
- (b)  Place the Greater or Equal to 0? function, located on the Functions»Arithmetic & Comparison»Express Comparison palette, on the block diagram. This function returns True if Number is greater than or equal to 0.
- (c)  Right-click the numeric constant and select Properties from the shortcut menu. Select the Format and Precision tab. Set Digits of precision to 1, select Floating point notation, and click the OK button to ensure there is no data conversion between the constant and the numeric indicator outside the Case structure.
- (d)  Place the One Button Dialog function, located on the Functions»All Functions»Time & Dialog palette, on the block diagram. This function displays a dialog box that contains the message Error...Negative Number.
- (e)  Right-click the message terminal of the One Button Dialog function, select Create»Constant from the shortcut menu, type Error...Negative Number in the constant, and click the Enter button on the toolbar or click outside the control. Refer to the lesson on Strings and File I/O (Section 9.1) for more information about strings.
- (f) Complete the diagram as shown in Figure 8.11.

2. Select the True case of the Case structure.  Place the Square Root function, located on the Functions»Arithmetic & Comparison»Express Numeric palette, on the block diagram. This function returns the square root of Number. Wire the function as shown in Figure 8.12.

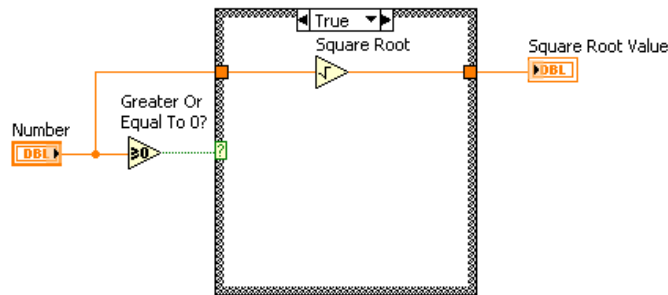

Figure 8.12

3. Save the VI as Square Root.vi in the C:\Exercises\LabVIEW Basics I directory.

8.3.3 Run the VI

1. Display the front panel and run the VI.

CAUTION: Do not run this VI continuously. Under certain circumstances, continuously running this VI could result in an endless loop.

If Number is positive, the VI executes the True case and returns the square root of Number. If Number is negative, the VI executes the False case, returns -99999, and displays a dialog box with the message Error...Negative Number.

2. Close the VI.

8.4 Temperature Control VI

Exercise 8.2:

8.4.1 Front Panel

1. Open the Temperature Running Average VI (Section 7.3).

2. Modify the front panel as shown in Figure 8.13.

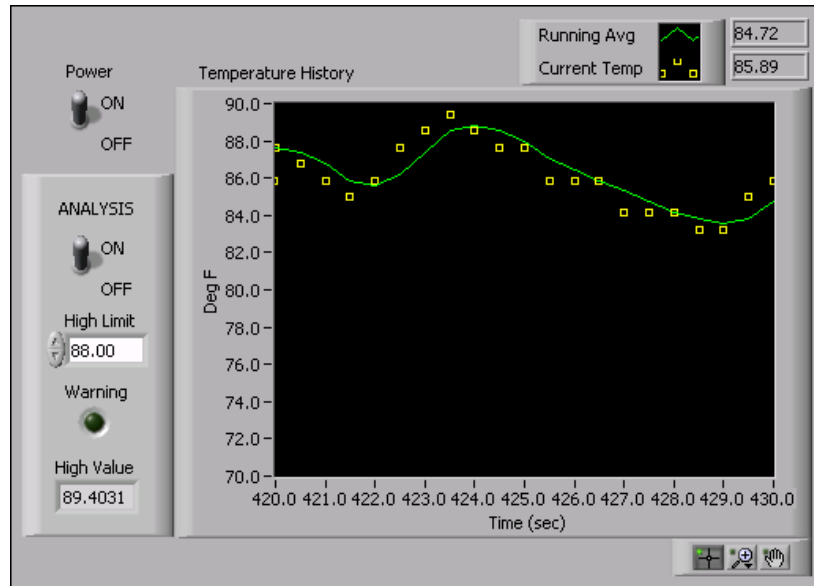

Figure 8.13

- (a) Place a horizontal smooth box, located on the Controls»All Controls»Decorations palette, on the front panel. This decoration visibly groups the Analysis items.
- (b) Create a duplicate of the Power Boolean switch. Label the new switch ANALYSIS. Right-click the switch and select Mechanical Action»Switch When Pressed from the shortcut menu.
- (c) Place a numeric control, located on the Controls»Numeric Controls palette, on the front panel. Label the control High Limit.
- (d) Place a round LED, located on the Controls»LEDs palette, on the front panel. Label the indicator Warning.
- (e) Place a numeric indicator from the Controls»Numeric Indicators palette, on the front panel. Label the indicator High Value.
- (f) Right-click the chart display and select Visible Items»Digital Display from the shortcut menu to display the digital values.

3. Select File»Save As to save the VI as Temperature Control.vi in the C:\Exercises\LabVIEW Basics I directory.

8.4.2 Block Diagram

1. Modify the block diagram as shown Figure 8.14. Enlarge the While Loop to create space for the new items.

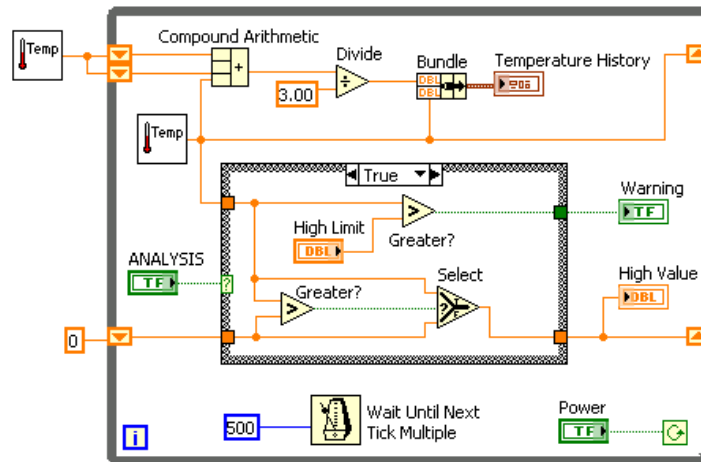
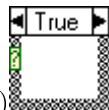

Figure 8.14



(a) Place the Case structure, located on the Functions>>Execution Control palette, on the block diagram. Wire the Analysis control to the selector terminal. Click the decrement or increment button to select the True case.



(b) Place two Greater? functions, located on the Functions>>Arithmetic & Comparison>>Express Comparison palette, on the block diagram. This function returns True if the temperature exceeds High Limit. Otherwise, the function returns False.



(c) Place the Select function, located on the Functions>>Arithmetic & Comparison>>Express Comparison palette, on the block diagram. This function returns the greater of the two input values.

(d) Wire the True case as shown in Figure 8.14.

(e) Click the decrement or increment button to select the False case.

2. Complete the False case of the Case Structure, shown in Figure 8.15.

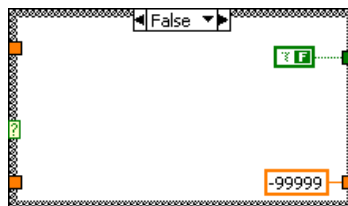

Figure 8.15

(a) Right-click the tunnel that connects to the Warning Indicator and select

Create»Constant. Use the Operating tool to change the Boolean constant to False.

- (b) Right-click the tunnel that connects to the High Value indicator and select Create»Constant. Enter -99999 for the value of the constant.

3. Save the VI. You will use this VI later in the course.

8.4.3 Run the VI

1. Display the front panel, type 80 in High Limit, and run the VI. If ANALYSIS is off, the VI turns off the Warning LED and displays a value of -99999 for High Value. If ANALYSIS is on, the VI turns on the Warning LED when the temperature is above High Limit and displays the current High Value.
2. Close the VI.

8.5 Formula Node

Use the Formula Node to perform mathematical operations in the LabVIEW environment. For additional functionality, you can link to the mathematics application MATLAB®.

8.5.1 Formula Node

The Formula Node is a convenient text-based node you can use to perform mathematical operations on the block diagram. Formula Nodes are useful for equations that have many variables or are otherwise complicated and for using existing text-based code. You can copy and paste the existing text-based code into a Formula Node rather than recreating it graphically on the block diagram.

Create the input and output terminals of the Formula Node by right-clicking the border of the node and selecting Add Input or Add Output from the shortcut menu, then enter the variable for the input or output. Type the equation in the structure. Each equation statement must terminate with a semicolon (;).

Formula Nodes also can be used for decision making. The block diagram shown in Figure 8.16 shows two different ways of using an if-then statement in a Formula Node. The two structures produce the same result.

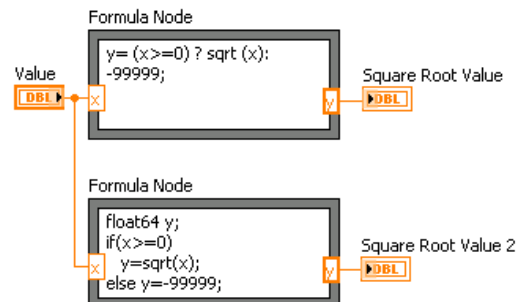

Figure 8.16

The Formula Node can perform many different operations. Refer to the *LabVIEW Help* for more information about functions, operations, and syntax for the Formula Node.

NOTE: The Formula Express VI located on the Functions»Arithmetic & Comparison palette uses a calculator interface to create mathematical formulas. You can use this Express VI to perform most math functions that a basic scientific calculator can compute. Refer to the *LabVIEW Help* for more information about the Formula Express VI.

8.6 Formula Node Exercise VI

Exercise 8.3:

8.6.1 Front Panel

1. Open a blank VI and build the front panel shown in Figure 8.17.

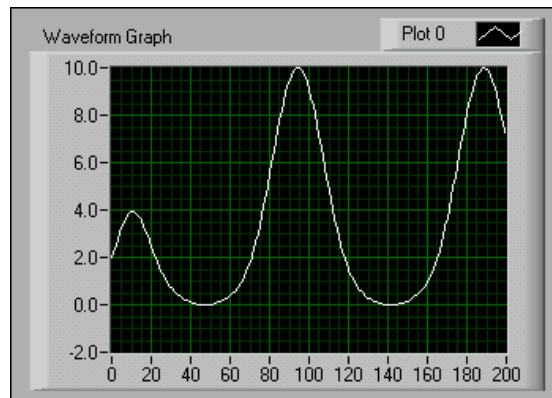

Figure 8.17

8.6.2 Block Diagram

1. Build the block diagram shown in Figure 8.18.

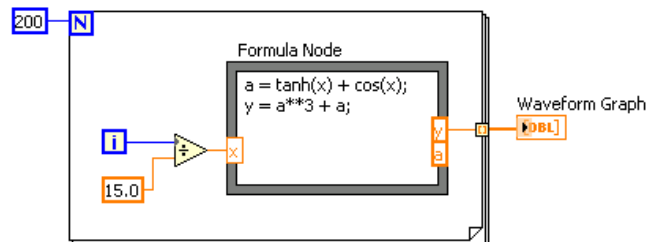

Figure 8.18

- (a) Place the Formula Node, located on the Functions»All Functions»Structures palette, on the block diagram.
- (b) Create the x input terminal by right-clicking the left border and selecting Add Input from the shortcut menu. Type x in the box that appears.
- (c) Create the y and a output terminals by right-clicking the right border and selecting Add Output from the shortcut menu. Enter y and a, respectively, in the boxes that appear. You must create output terminals for temporary variables like *a*.
NOTE: When you create an input or output terminal, you must use a variable name that exactly matches the one in the equation. Variable names are case sensitive.
- (d) Type the following equations in the Formula Node, where ** is the exponentiation operator. Refer to the *LabVIEW Help* for more information about syntax for the Formula Node.

```
a = tanh(x) + cos(x);
y = a**3 + a;
```

- (e) Complete the block diagram as shown in Figure 8.18.
2. Save the VI as Formula Node Exercise.vi in the C:\Exercises\ LabVIEW Basics I directory.

8.6.3 Run the VI

1. Display the front panel and run the VI. The graph displays the plot of the equation $y = f^3(x) + f(x)$, where $f(x) = \tanh(x) + \cos(x)$. During each iteration, the VI divides the iteration terminal value by 15.0. The quotient is wired to the Formula Node, which calculates the function value. The VI plots the array as a graph.
2. Close the VI.

8.7 Summary, Tips, and Tricks on Making Decisions in a VI

- The Select function selects between two inputs dependent on a third Boolean input.
- A Case structure has two or more subdiagrams, or cases. Only one subdiagram is visible at a time, and the structure executes only one case at a time.
- If the case selector terminal is a Boolean value, the structure has a True case and a False case. If the selector terminal is an integer, string, or enumerated type value, the structure can have up to $2^{31} - 1$ cases.
- Inputs are available to all subdiagrams of a Case structure, but subdiagrams do not need to use each input. If at least one output tunnel is not defined, all output tunnels on the structure appear as white squares.
- When creating a subVI from a Case structure, wire the error input to the selector terminal, and place all subVI code within the No Error case to prevent the subVI from executing if it receives an error.
- Formula Nodes are useful for equations that have many variables or are otherwise complicated and for using existing text-based code. Each equation statement must terminate with a semicolon (;).

8.8 Additional Exercises for Making Decisions in a VI

Exercise 8.4:

Build a VI that uses the Formula Node to calculate the following equations:

$$y_1 = x^3 + x^2 + 5$$

$$y_2 = mx + b$$

Use only one Formula Node for both equations and use a semicolon (;) after each equation in the node.

Save the VI as Equations.vi in the C:\Exercises\LabVIEW Basics I directory.

Exercise 8.5:

Build a VI that functions like a calculator. On the front panel, use numeric controls to input two numbers and a numeric indicator to display the result of the operation (Add, Subtract, Divide, or Multiply) that the VI performs on the two numbers. Use a slide control to specify the operation to perform.

Save the VI as Calculator.vi in the C:\Exercises\LabVIEW Basics I directory.

Exercise 8.6:

Modify the Square Root VI (Section 8.3) so the VI performs all calculations and condition checking using the Formula Node.

Select File»Save As to save the VI as Square Root 2.vi in the C:\Exercises\LabVIEW Basics I directory.

Exercise 8.7:

Build a VI that has two inputs, Threshold and Input Array, and one output, Output Array. Output Array contains values from Input Array that are greater than Threshold.

Save the VI as Array Over Threshold.vi in the C:\Exercises\LabVIEW Basics I directory.

Create another VI that generates an array of random numbers between 0 and 1 and uses the Array Over Threshold VI to output an array with the values greater than 0.5.

Save the VI as Using Array Over Threshold.vi in the C:\Exercises\LabVIEW Basics I directory.

Chapter 9

Strings and File I/O

9.1 Strings

A string is a sequence of displayable or non-displayable ASCII characters. Strings provide a platform-independent format for information and data. Some of the more common applications of strings include the following:

- Creating simple text messages.
- Passing numeric data as character strings to instruments and then converting the strings to numeric values.
- Storing numeric data to disk. To store numeric values in an ASCII file, you must first convert numeric values to strings before writing the numeric values to a disk file.
- Instructing or prompting the user with dialog boxes.

On the front panel, strings appear as tables, text entry boxes, and labels.

9.1.1 Creating String Controls and Indicators

Use the string control and indicator located on the Controls»Text Controls and Controls»Text Indicators palettes to simulate text entry boxes and labels. Use the Operating tool or Labeling tool to type or edit text in a string control. Use the Positioning tool to resize a front panel string object. To minimize the space that a string object occupies, right-click the object and select the Visible Items»Scrollbar option from the shortcut menu.

Right-click a string control or indicator on the front panel to select from the display types shown in the following table. The table also shows an example message for each display type.

Display Type	Description	Message
Normal Display	Displays printable characters using the font of the control. Non-printable characters generally appear as boxes. There are four display types.	There are four display types. \ is a backslash.
'\' Codes Display	Displays backslash codes for all non-displayable characters.	There\sare\sfour\sdisplay\stypes.\n\\\sis\sa\sbackslash.
Password Display	Displays an asterisk (*) for each character including spaces.	*****
Hex Display	Displays the ASCII value of each character in hex instead of the character itself.	5468 6572 6520 6172 6520 666F 7572 2064 6973 706C 6179 2074 7970 6573 2E0A 5C20 6973 2061 2062 6163 6B73 6C61 7368 2E

9.1.2 Tables

Use the table control located on the Controls»All Controls»List & Table palette or the Express Table VI located on the Controls»Text Indicators palette to create a table on the front panel. Each cell in a table is a string, and each cell resides in a column and a row. Therefore, a table is a display for a 2D array of strings. The illustration in Figure 9.1 shows a table and all its parts.

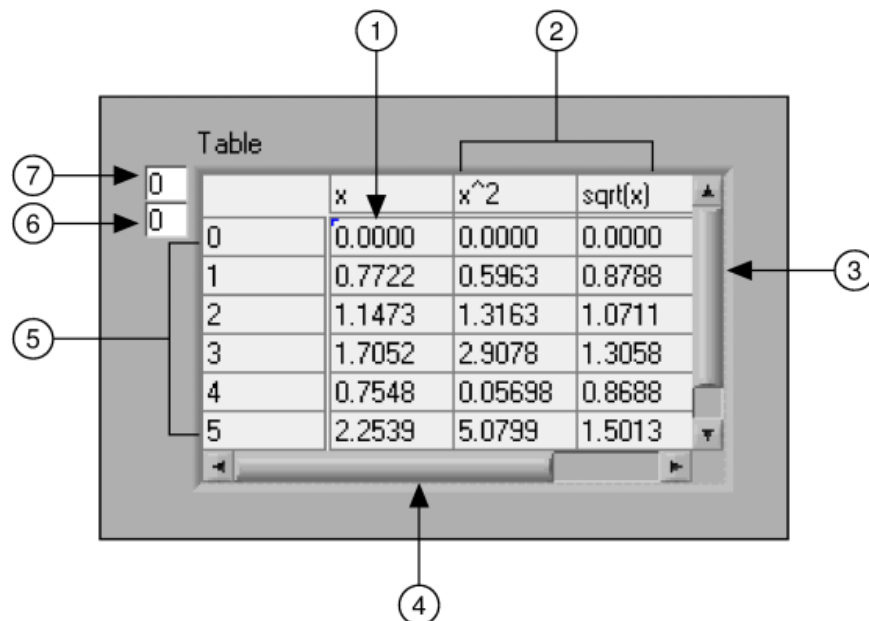

Figure 9.1: 1. Cell Indicated by Index Values, 2. Column Headings, 3. Vertical Scrollbar, 4. Horizontal Scrollbar, 5. Row Headings, 6. Horizontal Index, 7. Vertical Index

Define cells in the table by using the Operating tool or the Labeling tool to select a cell and typing text in the selected cell.

The table displays a 2D array of strings, so you must convert 2D numeric arrays to 2D string arrays before you can display them in a table indicator. The row and column headers are not automatically displayed as in a spreadsheet. You must create 1D string arrays for the row and column headers.

9.2 String Functions

Use the String functions located on the Functions»All Functions»String palette to edit and manipulate strings on the block diagram. String functions include the following:

- **String Length** - Returns in *length* the number of characters (bytes) *string*, including space characters. For example, the String Length function returns a *length* of 19 for the following string:

The quick brown fox

- **Concatenate Strings** - Concatenates input strings and 1D arrays of strings into a single output string. For array inputs, this function concatenates each element of the array. Add inputs to the function by right-clicking an input and selecting Add Input from the shortcut menu or by resizing the function. For example, concatenate the previous string with the following array of strings:

jumped	over	the	lazy	dog.
--------	------	-----	------	------

The Concatenate Strings function returns the following string:

The quick brown fox jumped over the lazy dog.

- **String Subset** - Returns the *substring* of the input *string* beginning at *offset* and containing *length* number of characters. The *offset* of the first character in *string* is 0. For example, if you use the previous string as the input, the String Subset function returns the following *substring* for an *offset* of 4 and a *length* of 5:

quick

- **Match Pattern** - Searches for *regular expression* in *string* beginning at *offset*, and if it finds a match, splits *string* into three substrings. If no match is found, *match substring* is empty and *offset past match* is -1 . For example, use a *regular expression* of `:` and use the following string as the input:

VOLTS DC: +1.22863E+1;

The Match Pattern function returns a *before substring* of VOLTS DC, a *match substring* of :, an *after substring* of +1.22863E+1;, and an *offset past match* of 9.

9.2.1 Converting Numeric Values to Strings with the Build Text Express VI

Use the Build Text Express VI to convert numeric values into strings. The Build Text Express VI, located on the Functions>>Output palette, concatenates an input string. If the input is not a string, this Express VI converts the input into a string based on the configuration of the Express VI.

When you place the Build Text Express VI on the block diagram, the Configure Build Text (Figure 9.2) dialog box appears. The dialog box (Figure 9.2) shows the Express VI configured to accept one input, voltage, and change it to a fractional number with a precision of 4. The input concatenates on the end of the string Voltage is. A space has been added to the end of the Voltage is string.

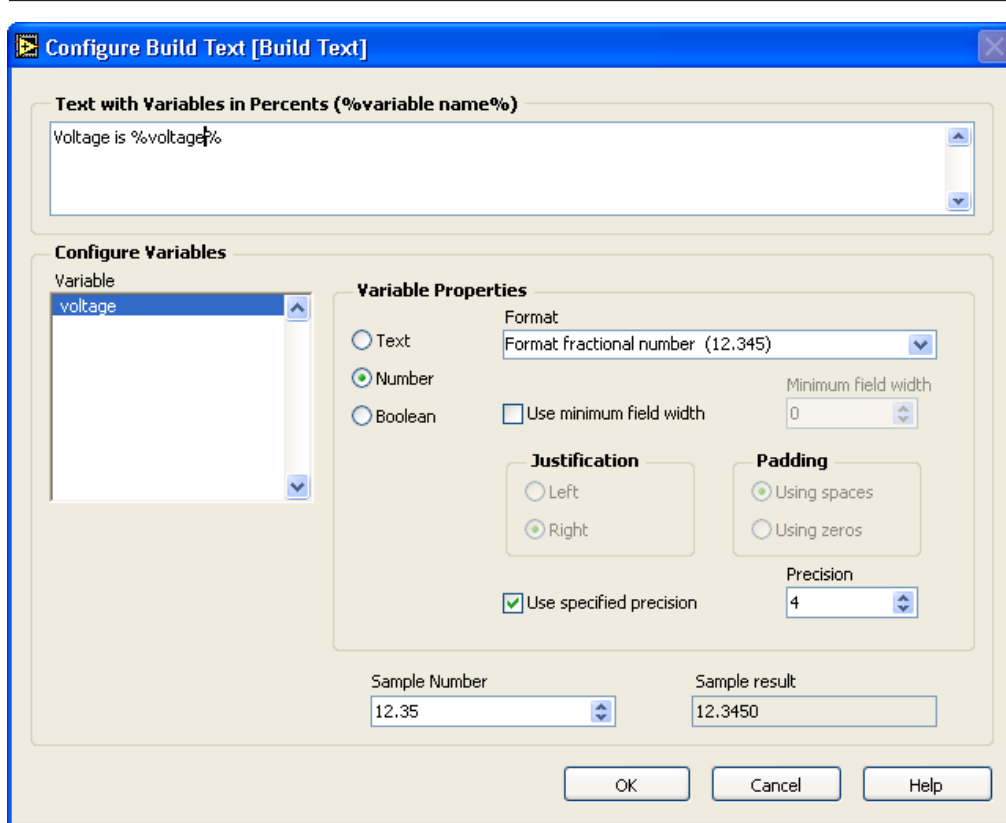

Figure 9.2

This configuration produces the block diagram shown in Figure 9.3. A probe has been added to view the value of the output string. The Build Text Express VI concatenates the Beginning Text input, in this case the voltage value, at the end of the configured text.

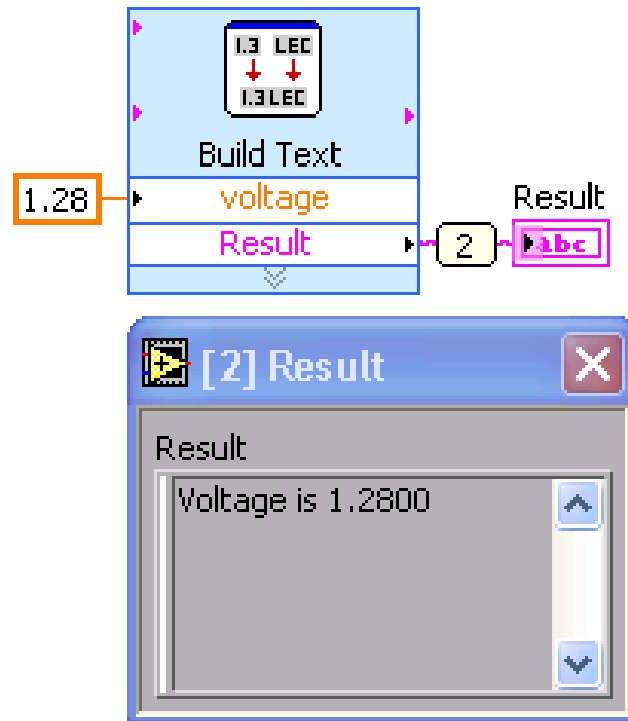

Figure 9.3

9.2.2 Converting Strings to Numeric Values with the Scan From String Function

The Scan From String function converts a string containing valid numeric characters, such as 0-9, +, -, e, E, and period (.), to a numeric value. This function scans the *input string* and converts the string according to *format string*. Use this function when you know the exact format of the input text. This function can scan *input string* into various data types, such as numeric or Boolean, based on the format string. Resize the function to increase the number of *outputs*.

Example 9.1:

For example, use a *format string* of %f, an *initial search location* of 8, and VOLTS DC+1.28E+2 as the *input string*, to produce an output of 128, as shown in the block diagram shown in Figure 9.4. Change the precision of the output by changing the precision of the indicator.

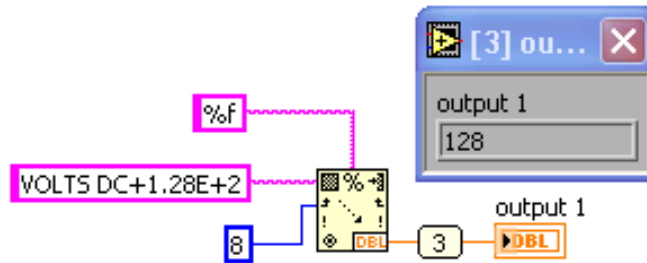

Figure 9.4

In *format string*, % begins the format specifier and f indicates a floating-point numeric with fractional format. Right-click the function and select Edit Scan String from the shortcut menu to create or edit a *format string*. The Edit Scan String (Figure 9.5) dialog box shows a configuration for the format string %4f.

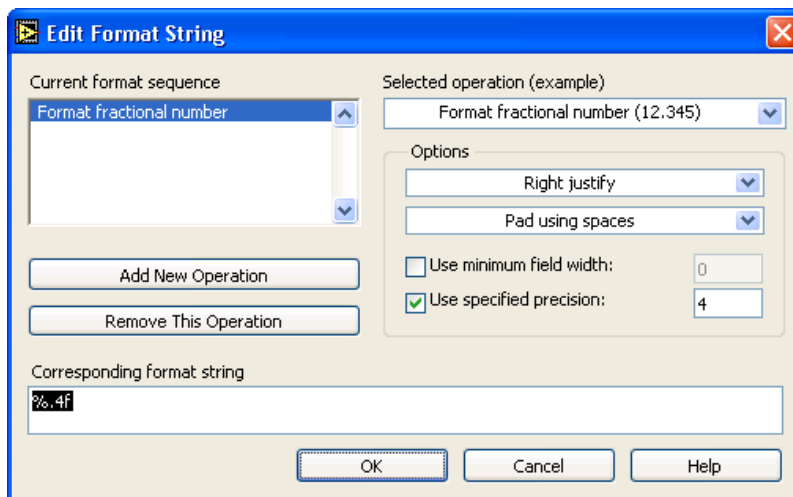

Figure 9.5

Refer to the *LabVIEW Help* for more information about format specifier syntax.

9.3 Create String VI

Exercise 9.1:

9.3.1 Front Panel

1. Open a blank VI and build the front panel shown in Figure 9.6. Do not add labels for the comments; they are shown for informational purposes only.

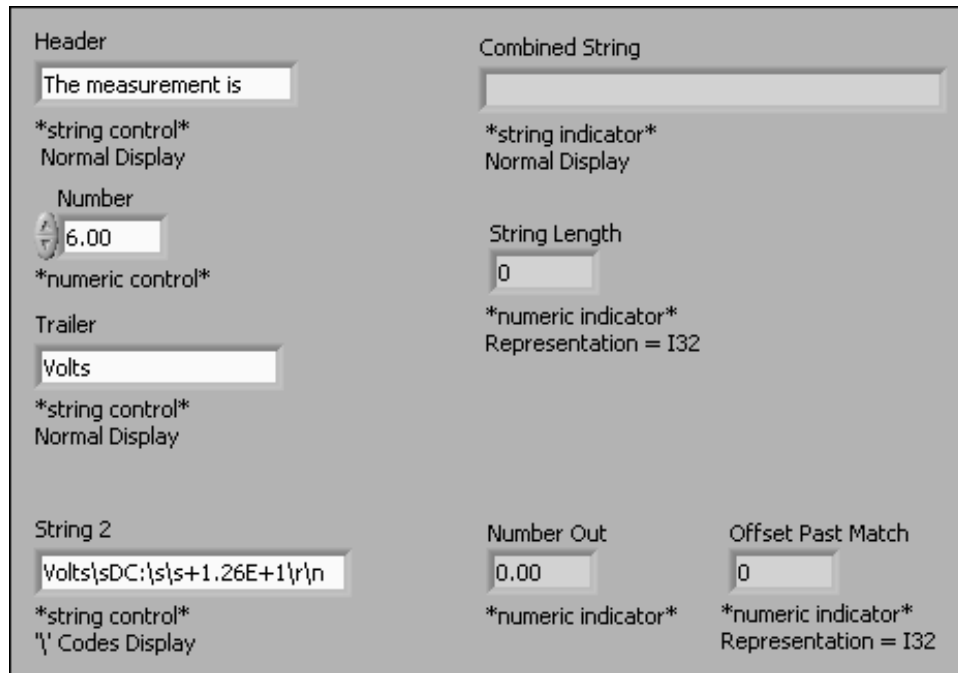

Figure 9.6

Use the following hints to build the front panel:

- Right-click String 2 and select '\ Codes Display from the shortcut menu. The text typed in String 2 is Volts DC: +1.26E+1. As shown using Codes display in the front panel above, there are two spaces after the colon (\s\s), and the text ends with a carriage return (\r\n). You may see only a \r or a \n for the carriage return.
- Change String Length and Offset Past Match to 32-bit signed integer (I32) representation.
- After entering text in the controls, select Operate>>Make Current Values Default to set the text as the default values of these controls.

9.3.2 Block Diagram

1. Build the block diagram shown in Figure 9.7.

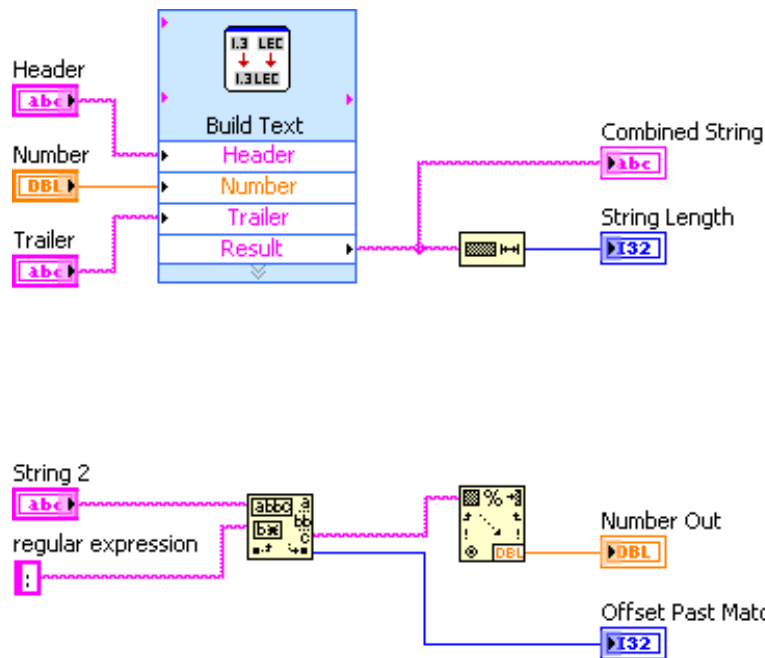





Figure 9.7

- (a)  Place the Build Text Express VI, located on the Functions»Output palette, on the block diagram. This function converts Number to a string. The Build Text configuration dialog box appears.
- i. Type %Header% %Number% %Trailer% in the Text with Variables in Percents text box to create three variables. The variables appear in the Configure Variables section.
 - ii. Select Number in the Variable section.
 - iii. In the Variable Properties section, select the Number option, set the Format to Format fractional number. Place a checkmark in the Use specified precision checkbox and set the Precision to 4. Leave the Header and Trailer variables in the default state.
 - iv. Click the OK button to close the dialog box.
- (b)  Place the String Length function, located on the Functions»All Functions»String palette, on the block diagram. This function returns the number of characters in Result.
- (c)  Place the Match Pattern function, located on the Functions»All Functions»String palette, on the block diagram. This function searches String 2 for a colon (:). Right-click the regular expression input, select Create»Constant from the shortcut menu, type a colon (:), and press the <Enter> key on the numeric keypad. You also can click the Enter button on the toolbar to complete the entry. Do not use the <Enter> key on the main keyboard because in this case it adds the return character to the search expression.



- (d) Place the Scan From String function, located on the Functions»All Functions»String palette, on the block diagram. This function converts the string after the colon to a numeric value.
- (e) Complete the block diagram as shown in Figure 9.7.

9.3.3 Icon & Connector Pane

1. Display the front panel and create an icon and connector pane so you can use this VI as a subVI later in this course. Refer to the lesson on Modular Programming (Section 3.1) for more information about creating icons and connector panes.

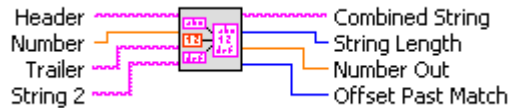

Figure 9.8

2. Save the VI as Create String.vi in the C:\Exercises\LabVIEW Basics I directory. You will use this VI later in the course.

9.3.4 Run the VI

1. Change the values of the front panel controls and run the VI. The VI concatenates Header, Number, and Trailer into Combined String and displays the string length. The VI also searches String 2 for a colon, converts the string following the colon to Number Out, and displays the index of the first character after the colon in Offset Past Match.
2. Save and close the VI.

9.4 File I/O VIs and Functions

File I/O operations pass data to and from files. Use the File I/O VIs and functions located on the Functions»All Functions»File I/O palette to handle all aspects of file I/O, including the following:

- Opening and closing data files
- Reading data from and writing data to files
- Reading from and writing to spreadsheet-formatted files
- Moving and renaming files and directories
- Changing file characteristics
- Creating, modifying, and reading configuration files

9.4.1 File I/O VIs

The File I/O palette is divided into four types of operations: high-level, low-level, advanced, and express.

9.4.1.1 High-Level File I/O VIs

Use the high-level File I/O VIs located on the top row of the Functions»All Functions»File I/O palette to perform common I/O operations. Refer to the High-Level File I/O VIs (Section 9.5) section for more information about the high-level File I/O VIs.

You can save time and programming effort by using the high-level VIs to write to and read from files. The high-level VIs perform read or write operations in addition to opening and closing the file. If an error occurs, the high-level VIs display a dialog box that describes the error. You can choose to halt execution or to continue. However, because high-level VIs encapsulate the entire file operation into one VI, they are difficult to customize to any use other than the one intended. Use low-level VIs for more specific tasks.

9.4.1.2 Low-Level and Advanced File I/O VIs and Functions

Use the low-level File I/O VIs and functions located on the middle row of the Functions»All Functions»File I/O palette and the Advanced File I/O functions located on the Functions»All Functions»File I/O»Advanced File Functions palette to control each file I/O operation individually.

Use the principal low-level functions to create or open a file, write data to or read data from the file, and close the file. The low-level VIs and functions can handle most file I/O needs. Refer to the *LabVIEW Basics II: Development Course Manual* for more information about the Advanced File I/O functions.

9.4.1.3 File I/O Express VIs

The Express VIs on the File I/O palette include the Read LabVIEW Measurement File Express VI and the Write LabVIEW Measurement File Express VI. The LabVIEW measurement data file (.lvm) is a tab-delimited text file you can open with a spreadsheet application or a text-editing application. In addition to the data an Express VI generates, the .lvm file includes information about the data, such as the date and time the data was generated.

Refer to the Data Acquisition and Waveforms (Section 10.1) section, for more information on using the File I/O Express VIs.

9.4.2 LabVIEW Data Directory



Use the default LabVIEW Data directory to store the data files LabVIEW generates, such as .lvm or .txt files. LabVIEW installs the LabVIEW Data directory in the default file directory for your operating system to help you organize and locate the data files LabVIEW generates. By default, the Write LabVIEW Measurement File Express VI stores the .lvm files it generates in this directory, and the Read LabVIEW Measurement File Express VI reads from this directory. The Default Data Directory constant, shown in pg 166, and the Default Data Directory property also return the LabVIEW Data directory by default.

Select Tools»Options and select Paths from the top pull-down menu to specify a different default data directory. The default data directory differs from the default directory, which is the directory you specify for new VIs, custom controls, VI templates, or other LabVIEW documents you create.

9.4.3 Basics of File I/O

A typical file I/O operation involves the following process:

1. Create or open a file. Indicate where an existing file resides or where you want to create a new file by specifying a path or responding to a dialog box to direct LabVIEW to the file location. After the file opens, a refnum represents the file. A reference number, or refnum, is a unique identifier for an object, such as a file, device, or network connection.
2. Read from or write to the file.
3. Close the file.

9.5 High-Level File I/O VIs

Most File I/O VIs and functions perform only one step in a file I/O operation. However, some high-level File I/O VIs designed for common file I/O operations perform all four steps. Although these VIs are not always as efficient as the low-level functions, you might find them easier to use.

Use the high-level File I/O VIs located on the top row of the File I/O palette to perform common I/O operations, such as writing to or reading from the following types of data:

- Characters to or from text files
- Lines from text files
- 1D or 2D arrays of single-precision numeric values to or from spreadsheet text files
- 1D or 2D arrays of single-precision numeric values or signed 16-bit integers to or from binary files

High-level File I/O VIs include the following:

- **Write to Spreadsheet File** - Converts a 2D or 1D array of single-precision numbers to a text string and writes the string to a new byte stream file or appends the string to an existing file. You also can transpose the data. The VI opens or creates the file before writing to it and closes it afterwards. You can use this VI to create a text file readable by most spreadsheet applications.
- **Read From Spreadsheet File** - Reads a specified number of lines or rows from a numeric text file beginning at a specified character offset and converts the data to a 2D single-precision array of numbers. The VI opens the file before reading from it and closes it afterwards. You can use this VI to read a spreadsheet file saved in text format.
- **Write Characters to File** - Writes a *character string* to a new byte stream file or appends the string to an existing file. The VI opens or creates the file before writing to it and closes it afterwards.
- **Read Characters From File** - Reads a specified number of characters from a byte stream file beginning at *start of read offset*. The VI opens the file before reading from it and closes it afterwards.
- **Read Lines From File** - Reads a specified number of lines from a text or binary file beginning at a specified character offset. The VI opens the file before reading from it and closes it afterwards.
- **Binary File VIs** - These VIs read from and write to binary files. Data can be integers or single-precision numbers.

9.6 Spreadsheet Example VI

Exercise 9.2:

9.6.1 Front Panel

1. Open the Spreadsheet Example VI located in the C:\Exercises\LabVIEW Basics I directory. The front panel in Figure 9.9 is already built.

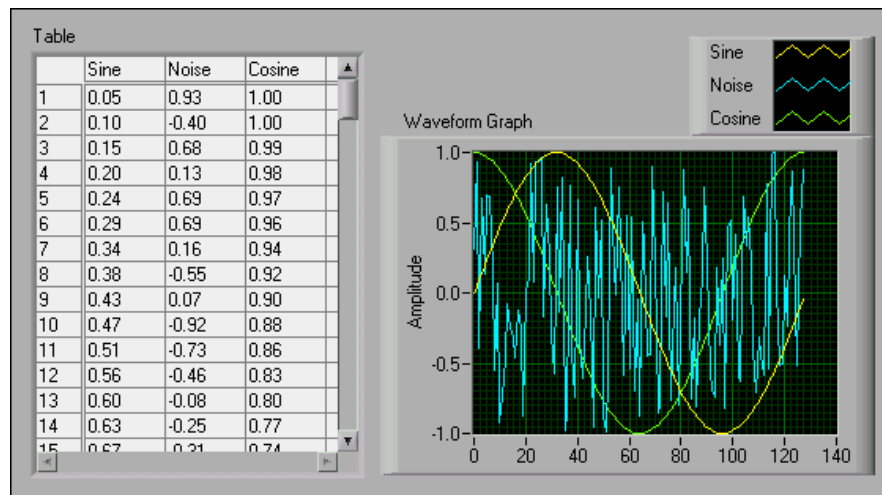

Figure 9.9

9.6.2 Run the VI

1. Run the VI. The VI generates a 2D array of 128rows \times 3columns. The first column contains data for a sine waveform, the second column contains data for a noise waveform, and the third column contains data for a cosine waveform. The VI plots each column in a graph and displays the data in a table.
2. When the Choose file to write dialog box appears, save the file as wave.txt in the C:\Exercises\LabVIEW Basics I directory and click the OK button. Later, you will examine this file.

9.6.3 Block Diagram

1. Display and examine the block diagram (Figure 9.10) for this VI.

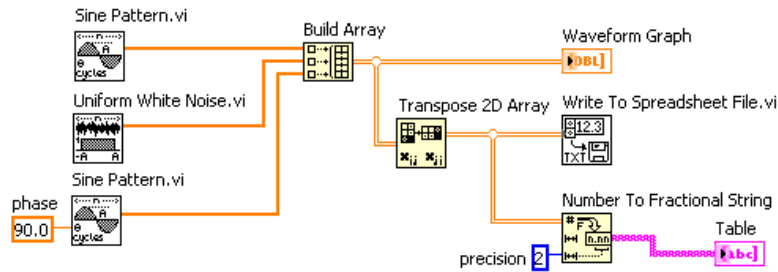





Figure 9.10

- 

The Sine Pattern VI located on the Functions»All Functions»Analyze»Signal Processing»Signal Generation palette returns a numeric array of 128 elements containing a sine pattern. The constant 90.0, in the second instance of the Sine Pattern VI, specifies the phase of the sine pattern or cosine pattern.
- 

The Uniform White Noise VI located on the Functions»All Functions»Analyze»Signal Processing»Signal Generation palette returns a numeric array of 128 elements containing a noise pattern.
- 

The Build Array function located on the Functions»All Functions»Array palette builds the 2D array from the sine array, noise array, and cosine array, as shown in Figure 9.11.

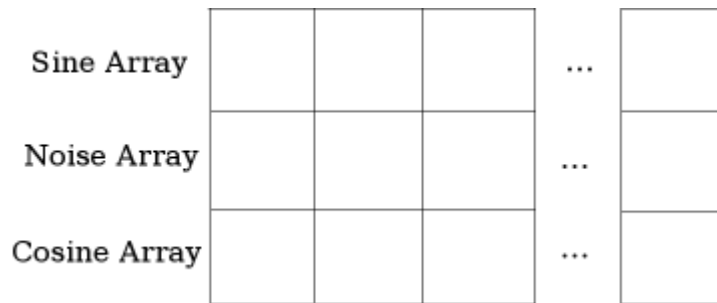



Figure 9.11

- 

The Transpose 2D Array function located on the Functions»All Functions»Array palette rearranges the elements of the 2D array so element $\{i, j\}$ becomes element $\{j, i\}$, as in Figure 9.12.

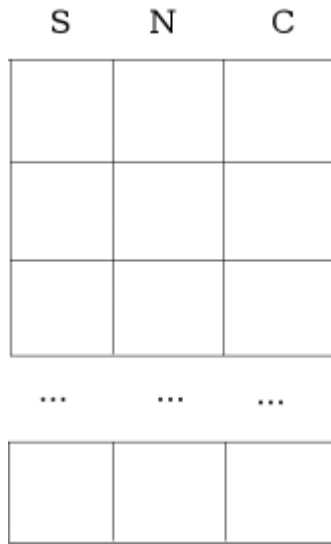



Figure 9.12

- 
 The Write To Spreadsheet File VI located on the Functions»All Functions»File I/O palette formats the 2D array into a spreadsheet string and writes the string to a file. The string has the format shown in Figure 9.13, where an arrow indicates a tab, and a paragraph symbol (¶) indicates an end of line character.

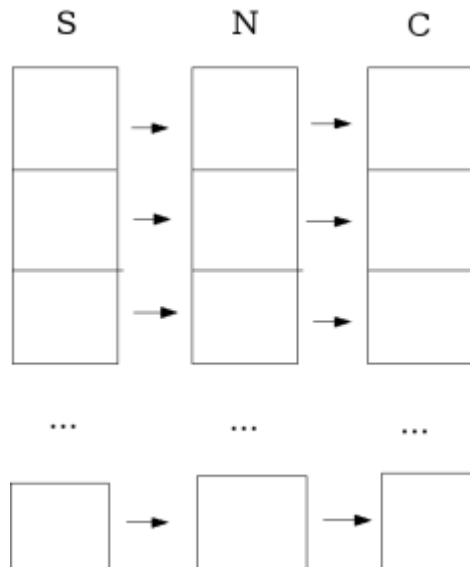



Figure 9.13

- 
 The Number To Fractional String function located on the Functions»All Functions»String»String/Number Conversion palette converts an array of nu-

meric values to an array of strings that the table displays.

2. Close the VI. Do not save changes.

NOTE: This example stores only three arrays in the file. To include more arrays, increase the number of inputs to the Build Array function.





9.6.4 Optional

Open the wave.txt file using a word processor or spreadsheet application and view its contents.

1. Open a word processor or spreadsheet application, such as (*Windows*) Notepad or WordPad, (*Mac OS*) SimpleText, or (*UNIX*) Text Editor.
2. Open wave.txt. The sine waveform data appear in the first column, the random waveform data appear in the second column, and the cosine waveform data appear in the third column.
3. Exit the word processor or spreadsheet application and return to LabVIEW.

9.7 Low-Level File I/O VI and Functions

Use the following low-level File I/O VI and functions to perform basic file I/O operations:

- **Open/Create/Replace File** -  Opens an existing file, creates a new file, or replaces an existing file, programmatically or interactively using a file dialog box. You can optionally specify a dialog prompt, default file name, start path, or filter pattern. If file path is empty, the VI displays a dialog box from which you can select a file.
- **Read File** -  Reads data from an open file specified by refnum and returns it in data. Reading begins at the current file mark or a location specified by pos mode and pos offset. How the data is read depends on the format of the specified file.
- **Write File** -  Writes data to an open file specified by refnum. Writing begins at a location specified by pos mode and pos offset for byte stream files and at the end of the file for datalog files. data, header, and the format of the specified file determine the amount of data written.
- **Close File** -  Closes an open file specified by refnum and returns the path to the file associated with the refnum. Error I/O operates uniquely in this function, which closes regardless of whether an error occurred in a preceding operation. This ensures that files are closed correctly.

9.7.1 Error Handling



The low-level File I/O VIs and functions return error information. Wire the error information from the beginning of the VI to the end. Include an error handler VI, such as the Simple Error Handler (pg 172) VI located on the Time & Dialog palette, at the end of the VI to determine if the VI ran without errors. Use the error in and error out clusters in each VI you use or build to pass the error information through the VI.

9.7.2 Saving Data in a New or Existing File

You can write any data type to a file you open or create with the File I/O VIs and functions. If other users or applications need to access the file, write string data in ASCII format to the file. Refer to the *LabVIEW Basics II: Development Course Manual* for more information about writing LabVIEW datalog or binary files.

You can access files either programmatically or interactively through a file dialog box. To access a file through a dialog box, do not wire file path in the Open/Create/Replace File VI. However, you can save time by programmatically wiring the default filename and path to the VI. pg 172 describes how pathnames are organized.

Platform	Pathname
Windows	Consists of the drive name, a colon, backslash-separated directory names, and the filename. For example, c:\testdata\test1.dat is the pathname to a file named test1.dat in the testdata directory.
UNIX	UNIX Consists of forward slash-separated directory names and the filename. For example, /home/testdata/test1.dat is the pathname to a file named test1.dat in the testdata directory in the /home directory. File-names and pathnames are case sensitive.
Mac OS	Consists of the volume name (the name of the disk), a colon, colon-separated folder names, and the filename. For example, Hard Disk:testdata:test1.dat is the pathname to a file named test1.dat in a folder named testdata on a disk named Hard Disk.

The block diagram shown in Figure 9.14 shows how to write string data to a file while programmatically wiring the filename and pathname. If the file already exists, it is replaced; otherwise a new file is created.

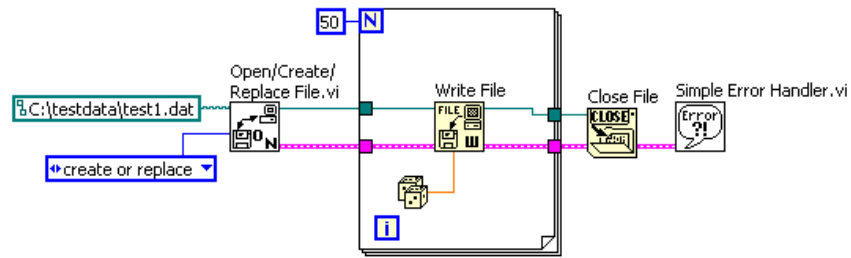

Figure 9.14

The Open/Create/Replace File VI opens the file test1.dat. The VI also generates a refnum and an error cluster.

When you open a file, device, or network connection, LabVIEW creates a refnum associated with that file, device, or network connection. All operations you perform on open files, devices, or network connections use refnums to identify each object.

The error cluster and refnum pass in sequence from one node to the next. Because a node cannot execute until it receives all its inputs, passing these two parameters forces the nodes to run in order and creates a data dependency. The Open/Create/Replace File VI passes the refnum and error cluster to the Write File function, which writes the data to disk. When the Write File function finishes execution, it passes the refnum and error cluster to the Close File function, which closes the file. The Simple Error Handler VI examines the error cluster and displays a dialog box if an error occurred. If an error occurs in one node, subsequent nodes do not execute, and the VI passes the error cluster to the Simple Error Handler VI.

9.8 File Writer VI

Exercise 9.3:

9.8.1 Front Panel

1. Open a blank VI and build the front panel shown in Figure 9.15.

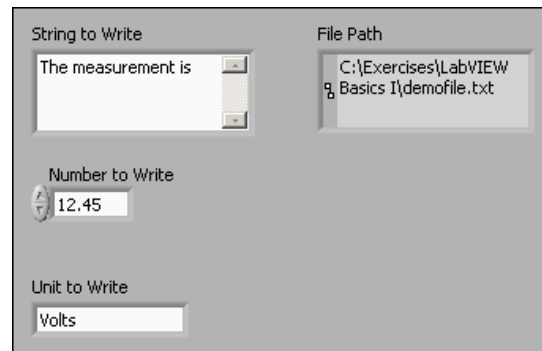

Figure 9.15

- Place a path indicator located on the Controls>>Text Indicators palette on the front panel. This indicator displays the path for the data file you create.
- Right-click the String to Write control and select Visible Items>>Scrollbar from the shortcut menu to display a scrollbar.

9.8.2 Block Diagram

- Build the block diagram shown in Figure 9.16.

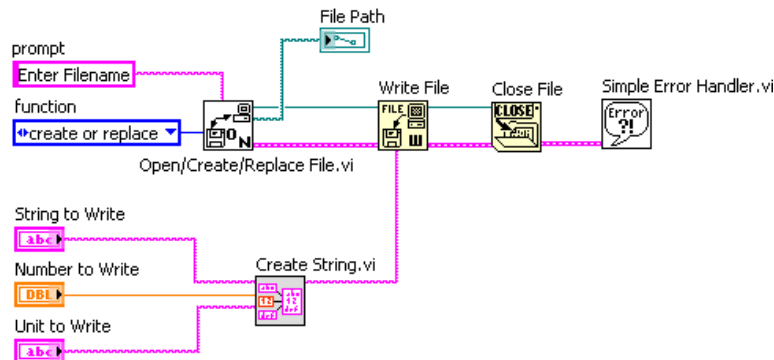





Figure 9.16

-  Place the Create String VI from the previous exercise¹ on the block diagram. Select Functions>>All Functions>>Select a VI and navigate to C:\Exercises\LabVIEW Basics I\Create String.vi. This subVI concatenates the three input strings to one combined string.
-  Place the Open/Create/Replace File VI, located on the Functions>>All Functions>>File I/O palette, on the block diagram. This VI displays a dialog box

¹ "" <<http://cnx.org/content/mex81/latest/>>

to open or create a file. Right-click the prompt input, select **Create»Constant** from the shortcut menu, and type **Enter Filename** in the constant. When the VI runs, a file navigation dialog box appears with **Enter Filename** as the title of the window. Right-click the function input, select **Create»Constant** from the shortcut menu, and click the constant with the **Operating** tool to select **create** or **replace**.

- (c)  Place the **Write File** function, located on the **Functions»All Functions»File I/O** palette, on the block diagram. This function writes the concatenated strings to the file.

- (d)  Place the **Close File** function, located on the **Functions»All Functions»File I/O** palette, on the block diagram. This function closes the file.

- (e)  Place the **Simple Error Handler VI**, located on the **Functions»All Functions»Time & Dialog** palette, on the block diagram. This function checks the error cluster and displays a dialog box if an error occurs.

- (f) Complete the block diagram as shown in Figure 9.16.

2. Save the VI as **File Writer.vi** in the **C:\Exercises\LabVIEW Basics I** directory.

9.8.3 Run the VI

1. Enter values in the front panel controls and run the VI. An **Enter Filename** dialog box appears.
2. Type **demofile.txt** and click the **Save** or **OK** button to save the file. The VI writes the **String to Write**, **Numeric to Write**, and **Unit to Write** values to the file.
3. Close the VI.

9.9 File Reader VI

Exercise 9.4:

9.9.1 Front Panel

1. Open a blank VI and build the front panel shown in Figure 9.17 using the file path control located on the **Controls»Text Controls** palette and a string indicator located on the **Controls»Text Indicators** palette.

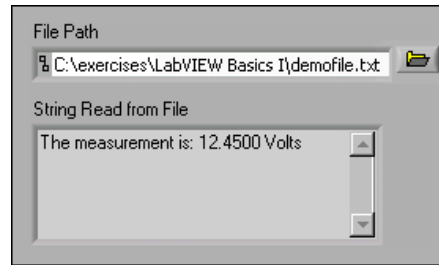

Figure 9.17

9.9.2 Block Diagram

1. Build the block diagram shown in Figure 9.18.

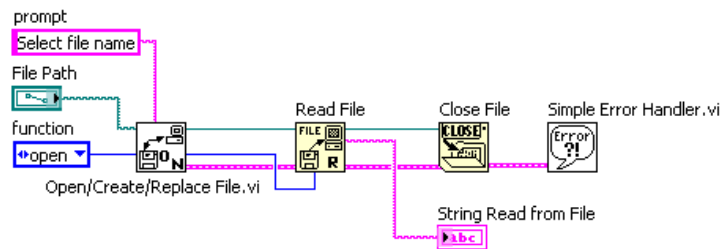





Figure 9.18

- (a)  Place the Open/Create/Replace File VI, located on the Functions»All Functions»File I/O palette, on the block diagram. This VI displays a dialog box that you use to open or create a file. Right-click the prompt input, select Create»Constant from the shortcut menu, and type Select Filename in the constant. Right-click the function input, select Create»Constant from the shortcut menu, and click the constant with the Operating tool to select open.
- (b)  Place the Read File function, located on the Functions»All Functions»File I/O palette, on the block diagram. This function reads count bytes of data from the file starting at the beginning of the file.
- (c)  Place the Close File function, located on the Functions»All Functions»File I/O palette, on the block diagram. This function closes the file.
- (d)  Place the Simple Error Handler VI, located on the Functions»All Functions»Time & Dialog palette, on the block diagram. This VI checks the error cluster and displays a dialog box if an error occurs.
- (e) Complete the block diagram as shown in Figure 9.18.

2. Save the VI as File Reader.vi in the C:\Exercises\LabVIEW Basics I directory.

9.9.3 Run the VI

1. Display the front panel and use the Operating tool to click the Browse button in the path control.
2. Navigate to demofile.txt and click the Open or OK button.
3. Run the VI. String Read from File displays the contents of the file.
4. If time permits, complete the challenge step (Section 9.9.4). Otherwise, save and close the VI.

9.9.4 Challenge

1. Modify the VI so it parses the numeric value and displays the numeric value in a numeric indicator. After you finish, save and close the VI.

TIP: Use the Match Pattern function to search for the first numeric character.

9.10 Formatting Spreadsheet Strings

To write data to a spreadsheet file, you must format the string as a spreadsheet string, which is a string that includes delimiters, such as tabs. In many spreadsheet applications, the tab character separates columns, and the end of line character separates rows.

NOTE: Use the end of line constant located on the Functions»All Functions»String palette to ensure portability of VIs among platforms. (*Windows*) The constant inserts a carriage return and a linefeed. (*Mac OS*) The constant inserts a carriage return. (*UNIX*) The constant inserts a linefeed.

Use the Write To Spreadsheet File VI or the Array To Spreadsheet String function to convert a set of numbers from a graph, a chart, or an acquisition into a spreadsheet string. If you want to write numbers and text to a spreadsheet or word processing application, use the String functions and the Array functions to format the data and to combine the strings. Then write the data to a file.

9.10.1 Format Into File

Use the Format Into File function to format string, numeric, path, and Boolean data as text and write the text to a file. Often you can use this function instead of separately formatting the string with the Format Into String function or Build Text Express VI and writing the resulting string with the Write Characters To File VI or Write File function.

Use the Format Into File function to determine the order in which the data appears in the text file. However, you cannot use this function to append data to a file or overwrite existing data in a file. For these operations, use the Format Into String function with the Write File function. You can wire a refnum or path to the input file terminal of the Format Into File function, or you can leave this input unwired for a dialog box to prompt you for the filename.

In the block diagram shown in Figure 9.19, the Open/Create/Replace File VI opens a file, and the For Loop executes five times. The Format Into File function converts the iteration count and the random number to strings and places the tab and end of line characters in the correct positions to create two columns and one row in spreadsheet format. After the loop completes five iterations, the file closes, and the VI checks the error condition.

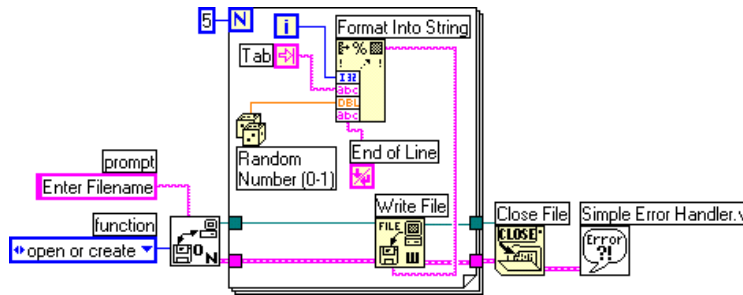

Figure 9.19

This VI creates this text file, where an arrow (→) indicates a tab, and a paragraph symbol (¶) indicates an end of line character.

```
0→ 0.798141¶
1→ 0.659364¶
2→ 0.581409¶
3→ 0.526433¶
4→ 0.171062¶
```

You can open the previous text file in a spreadsheet application to display the spreadsheet shown in Figure 9.20.

	A	B
1	0	0.798141
2	1	0.659364
3	2	0.581409
4	3	0.526433
5	4	0.171062

Figure 9.20

9.10.2 Write LabVIEW Measurement File

In the block diagram shown in Figure 9.21, the Write LabVIEW Measurement File Express VI includes the open, write, close, and error handling functions. It also handles formatting the string with either a tab or comma delimiter. The Merge Signals function combines the iteration count and the random number into the dynamic data type.

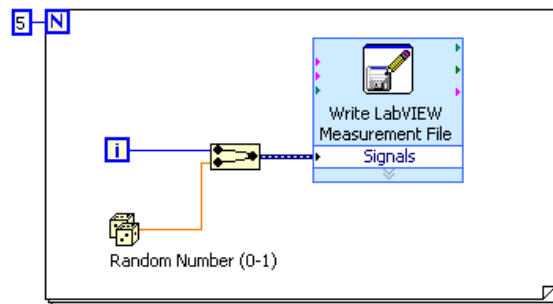

Figure 9.21

The dialog box in Figure 9.22 shows the configuration for the Write LabVIEW Measurement File Express VI.

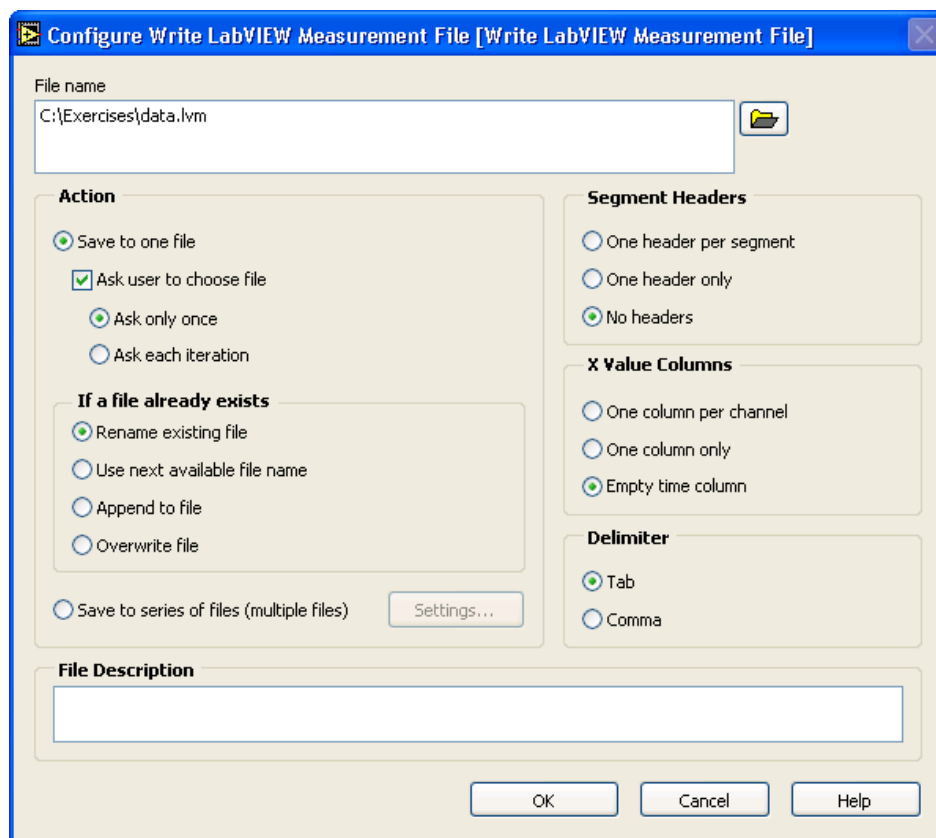

Figure 9.22

This VI creates a .lvm file which you can open in a spreadsheet application. Figure 9.23 shows an example of the spreadsheet created by the previous configuration of the Write LabVIEW Measurement File Express VI.

	A	B	C	D
1		0	0.385055	
2		1	0.23516	
3		2	0.985184	
4		3	0.177893	
5		4	0.935915	
6				
7				

Figure 9.23

Refer to the lesson on Data Acquisition and Waveforms (Section 9.7), for more information about the Write LabVIEW Measurement File and Read LabVIEW Measurement File Express VIs.

9.11 Temperature Logger VI

Exercise 9.5:

9.11.1 Block Diagram

1. Open the Temperature Control VI (Section 8.4) and save it as Temperature Logger.vi in the C:\Exercises\LabVIEW Basics I directory. You do not need to modify the front panel.
2. Open and modify the block diagram as shown in Figure 9.24. Resize the While Loop to add space at the top for the file I/O operations.

need to be formatted. You can leave them in the default state.

iii. Click the OK button to close the configuration dialog box.

iv. Right-click the Build Text Express VI and select View As Icon to conserve block diagram space.

- (d)  Place a Tab constant and an End of Line constant, located on the Functions»All Functions»String palette, on the block diagram.

- (e)  Place the Write File function, located on the Functions»All Functions»File I/O palette, on the block diagram. This function writes to the file specified by refnum.

- (f)  Place the Close File function, located on the Functions»All Functions»File I/O palette, on the block diagram. This function closes the file.

- (g)  Place the Simple Error Handler VI, located on the Functions»All Functions»Time & Dialog palette, on the block diagram. This VI checks the error cluster and displays a dialog box if an error occurs.

(h) Complete the block diagram as shown in Figure 9.24.

3. Save the VI. You will use this VI later in the course.

9.11.2 Run the VI

1. Display the front panel and run the VI. The Enter File Name dialog box appears.
2. Type temp.txt and click the Save or OK button. The VI creates a file called temp.txt. The VI takes readings every half-second and saves the time and temperature data to a file until you click the Power switch. When the VI finishes, it closes the file.
3. Open a word processor or spreadsheet application, such as (*Windows*) Notepad or WordPad, (*Mac OS*) SimpleText, or (*UNIX*) Text Editor.
4. Open the temp.txt file in the word processing or spreadsheet application. The time appears in the first column, and the temperature data appears in the second column.
5. Exit the word processor or spreadsheet application and return to LabVIEW.
6. If time permits, complete the optional steps. Otherwise, close the VI.

9.11.3 Optional

When using error handling in a VI, the While Loop should stop executing when an error occurs. Complete the following steps to modify the VI so it stops when the user clicks the Power switch or an error occurs.

1. Edit the block diagram as shown in Figure 9.25.

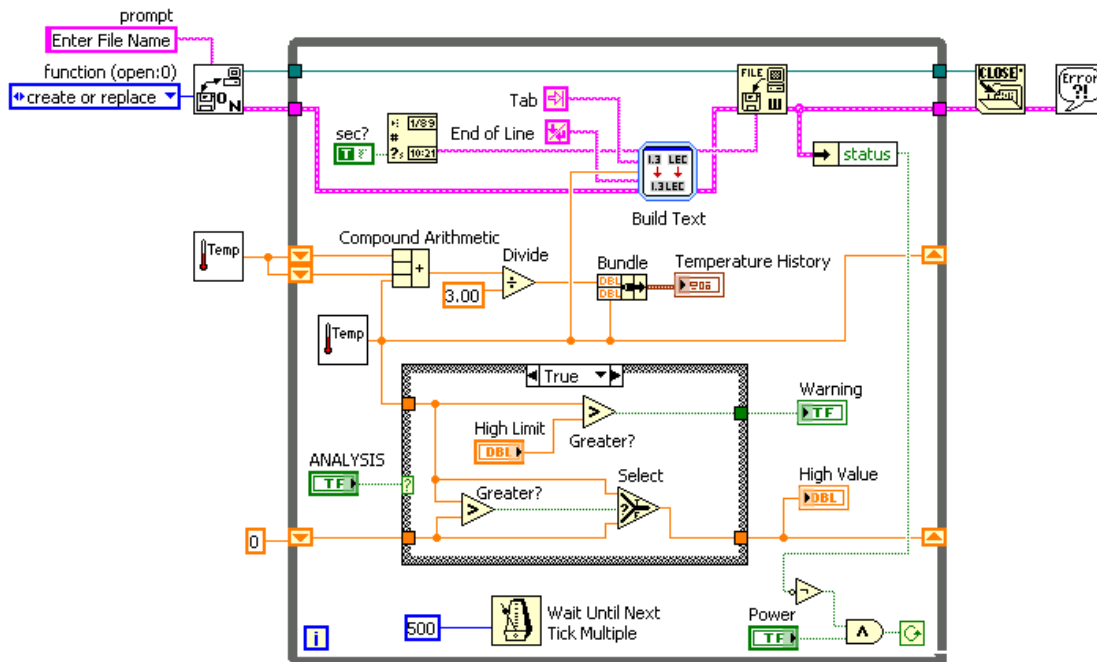





Figure 9.25

- (a)  Place the Unbundle by Name function, located on the Functions>>All Functions>>Cluster palette, on the block diagram. This function reads the status output from the error cluster.
- (b)   Place the Not function and the And function, located on the Functions>>Arithmetic & Comparison>>Express Boolean palette, on the block diagram. These functions set the conditional terminal to continue while Power is True and no error occurs.

2. Save and run the VI.

3. Test the error handling by deleting the refnum wire between the Write File function and the left border of the While Loop. Right-click the refnum input of Write File and select Create>>Constant.

4. Run the VI again. The VI should wait for a path, then stop immediately with an error. If error handling was not included in this VI, the VI would not report the error until the user stopped the VI.

5. If time permits, complete the challenge steps. Otherwise, close the VI. Do not save changes.

9.11.4 Challenge

1. Replace the Build Text Express VI and the Write File function with the Format Into File function.
2. Run the VI.
3. Close the VI. Do not save changes.

9.12 Temperature Application VI

Exercise 9.6:

1. Build a VI that performs the following tasks.
 - (a) Takes a temperature measurement once every second until you stop the VI or an error occurs.
 - (b) Displays both the current temperature and the average of the last three measurements on a waveform chart.
 - (c) If the temperature exceeds a limit, turns on an LED.
 - (d) After each measurement, logs the date, time including seconds, temperature, average of the last three measurements, and a one-word message describing whether the temperature is normal or over the limit. Logs data so each item appears in one column of a spreadsheet, as shown in Figure 9.26.

	A	B	C	D	E
1	Date	Time	Temp	Avg	Comment
2	9/26/00	12:45:17 AM	74.46	74.46	Normal
3	9/26/00	12:45:18 AM	74.46	74.46	Normal
4	9/26/00	12:45:19 AM	74.46	74.46	Normal
5	9/26/00	12:45:20 AM	74.46	74.46	Normal

Figure 9.26

- (e) After you stop the acquisition, plots both the raw temperature data and a best-fit curve in an XY graph and displays the average, maximum, and minimum temperatures.

TIP: Start with the Temperature Logger VI (Section 9.11). To complete this step (pg 184), use portions of the Temperature Analysis VI (Section 7.6).

TIP: The Build Text Express VI is limited to eight inputs. Use multiple Build Text Express VIs or use the Format into String function. You can build the delimiters into the format string to require fewer inputs.

The front panel should be similar to Figure 9.27.

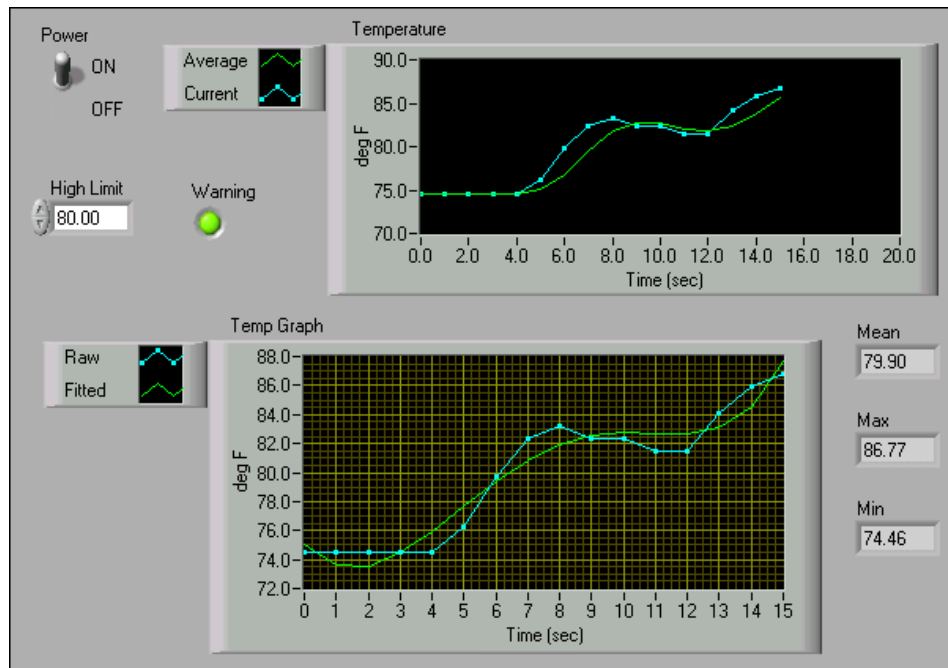

Figure 9.27

2. Save the VI as Temperature Application.vi in the C:\Exercises\LabVIEW Basics I directory.

9.13 Summary, Tips, and Tricks on Strings and File I/O

- Strings group sequences of ASCII characters. Use the string control and indicator to simulate text entry boxes and labels.
- To minimize the space that a string object occupies, right-click the object and select Show Scrollbar from the shortcut menu.
- Use the String functions located on the Functions»All Functions»String palette to edit and manipulate strings on the block diagram.
- Use the Build Text Express VI to convert a numeric value to a string.
- Use the Scan From String function to convert a string to a numeric value.
- Right-click the Scan From String function and select Edit Scan String from the shortcut menu to create or edit a format string.
- Use the File I/O VIs and functions to handle all aspects of file I/O.
- Use the high-level File I/O VIs to perform common I/O operations.
- Use the low-level File I/O VI and functions and the Advanced File I/O functions located to control each file I/O operation individually.
- Use the Express File I/O VIs for simple datalogging operations.

- When writing to a file, you open, create, or replace a file, write the data, and close the file. Similarly, when you read from a file, you open an existing file, read the data, and close the file.
- To access a file through a dialog box, leave file path unwired in the Open/Create/Replace File VI.
- To write data to a spreadsheet file, the string must be formatted as a spreadsheet string, which is a string that includes delimiters, such as tabs. Use the Format Into File function to format string, numeric, path, and Boolean data as text and write the text to a file.

9.14 Additional Exercises for Strings and FileI/O

Exercise 9.7:

Build a VI that generates a 2D array of 3rows \times 100columns of random numbers and writes the data transposed to a spreadsheet file. Add a header to each column. Use the high-level File I/O VIs located on the File I/O palette.

TIP: Use the Write Characters To File VI to write the header and the Write To Spreadsheet File VI to write the numeric data to the same file.

Save the VI as More Spreadsheets.vi in the C:\Exercises\LabVIEW Basics I directory.

Exercise 9.8:

Build a VI that converts tab-delimited spreadsheet strings to comma-delimited spreadsheet strings, that is, spreadsheet strings with columns separated by commas and rows separated by end of line characters. Display both the tab-delimited and comma-delimited spreadsheet strings on the front panel.

TIP: Use the Search and Replace String function.

Save the VI as Spreadsheet Converter.vi in the C:\Exercises\LabVIEW Basics I directory.

Exercise 9.9:

Modify the Temperature Logger VI (Section 9.11) so the VI does not create a new file each time you run the VI. Append the data to the end of the existing temp.dat file that the Temperature Logger VI created. Run the VI several times and use a word processor application to confirm that the VI appended new temperature readings.

TIP: Delete the Format Into File function and replace it with the Format Into String and Write File functions. Use the pos mode and pos offset parameters of the Write File function to move the current file mark.

Select File \gg Save As to save the VI as Temperature Logger 2.vi in the C:\Exercises\LabVIEW Basics I directory.

Chapter 10

Data Acquisition and Waveforms

10.1 Overview and Configuration of DAQ Devices

LabVIEW includes a set of VIs that let you configure, acquire data from, and send data to DAQ devices. Often, one device can perform a variety of functions— analog-to-digital (A/D) conversion, digital-to-analog (D/A) conversion, digital I/O, and counter/timer operations. Each device supports different DAQ and signal generation speeds. Also, each DAQ device is designed for specific hardware platforms and operating systems. Refer to ni.com/daq¹ for more information about DAQ devices.

10.1.1 DAQ System Components

Before a computer-based measurement system can measure a physical signal, such as temperature, a sensor or transducer must convert the physical signal into an electrical one, such as voltage or current. You might consider the plug-in DAQ device to be the entire measurement system, but it is actually only one system component. You cannot always directly connect signals to a plug-in DAQ device. In these cases, you must use signal conditioning accessories to condition the signals before the plug-in DAQ device converts them to digital information. The software controls the DAQ system by acquiring the raw data, analyzing, and presenting the results.

Consider the following options for a DAQ system:

- The plug-in DAQ device resides in the computer. You can plug the device into the PCI slot of a desktop computer or the PCMCIA slot of a laptop computer for a portable DAQ measurement system.
- The DAQ device is external and connects to the computer through an existing port, such as the serial port or Ethernet port, which means you can quickly and easily place measurement nodes near sensors.

The computer receives raw data through the DAQ device. The application you write presents and manipulates the raw data in a form you can understand. The software also controls the DAQ system by commanding the DAQ device when and from which channels to acquire data. Typically, DAQ software includes drivers and application software. Drivers are unique to the device or type of device and include the set of commands the device accepts. Application software, such as LabVIEW, sends the drivers commands, such as acquire and return a thermocouple reading. The application software also displays and analyzes the acquired data. NI measurement devices include NI-DAQ driver software, a collection of VIs you use to configure, acquire data from, and send data to the measurement devices.

¹<http://ni.com/daq>

10.1.1.1 NI-DAQ

NI-DAQ 7.0 contains two NI-DAQ drivers—Traditional NI-DAQ and NI-DAQmx—each with its own application programming interface (API), hardware configuration, and software configuration.

- Traditional NI-DAQ is an upgrade to NI-DAQ 6.9.x, the earlier version of NI-DAQ. Traditional NI-DAQ has the same VIs and functions and works the same way as NI-DAQ 6.9.x. You can use Traditional NI-DAQ on the same computer as NI-DAQmx, which you cannot do with NI-DAQ 6.9.x.
- NI-DAQmx is the latest NI-DAQ driver with new VIs, functions, and development tools for controlling measurement devices. The advantages of NI-DAQmx over previous versions of NI-DAQ include the DAQ Assistant for configuring channels and measurement tasks for a device; increased performance, including faster single-point analog I/O and multithreading; and a simpler API for creating DAQ applications using fewer functions and VIs than earlier versions of NI-DAQ.

Traditional NI-DAQ and NI-DAQmx support different sets of devices. Refer to the National Instruments Web site² for the list of supported devices. This lesson describes the NI-DAQmx API. Figure 10.1 shows the measurement software framework.

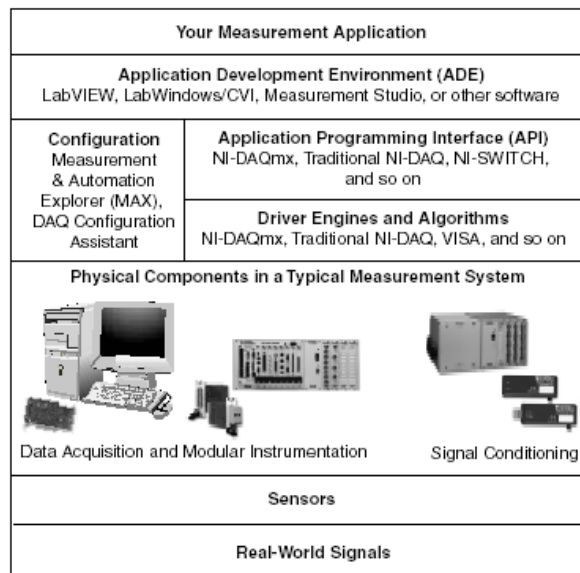

Figure 10.1

When programming an NI measurement device, you can use NI application software such as LabVIEW, LabWindows™/CVI™, and Measurement Studio, or open ADEs that support calling dynamic link libraries (DLLs) through ANSI C interfaces. Using NI application software greatly reduces development time for data acquisition and control applications regardless of which programming environment you use:

²<http://ni.com/daq>

- LabVIEW supports data acquisition with the LabVIEW DAQ VIs, a series of VIs for programming with NI measurement devices.
- For C developers, LabWindows/CVI is a fully integrated ANSI C environment that provides the LabWindows/CVI Data Acquisition library for programming NI measurement devices.
- Measurement Studio development tools are for designing your test and measurement software in Microsoft Visual Studio .NET. Measurement Studio includes tools for Visual C#, Visual Basic .NET, and Visual C++ .NET.

10.1.2 DAQ Hardware Configuration

You must complete several steps before you can use the Data Acquisition VIs. The devices are configured for the computers in this class.

10.1.2.1 Windows

The Windows Configuration Manager keeps track of all the hardware installed in the computer, including National Instruments DAQ devices. If you have a Plug & Play (PnP) device, such as an E Series MIO device, the Windows Configuration Manager automatically detects and configures the device. If you have a non-PnP device, or legacy device, you must configure the device manually using the Add New Hardware option in the Control Panel.

You can verify the Windows Configuration by accessing the Device Manager. You can see Data Acquisition Devices, which lists all DAQ devices installed in the computer. Double-click a DAQ device to display a dialog box with tabbed pages. The General tab displays overall information regarding the device. The Resources tab specifies the system resources to the device such as interrupt levels, DMA, and base address for software-configurable devices. The NI-DAQ Information tab specifies the bus type of the DAQ device. The Driver tab specifies the driver version and location for the DAQ device.

LabVIEW installs Measurement & Automation Explorer (MAX), which establishes all device and channel configuration parameters. After installing a DAQ device in the computer, you must run this configuration utility. MAX reads the information the Device Manager records in the Windows Registry and assigns a logical device number to each DAQ device. Use the device number to refer to the device in LabVIEW. Access MAX either by double-clicking the icon on the desktop or selecting Tools»Measurement & Automation Explorer in LabVIEW. The window in Figure 10.2 is the primary MAX window. MAX is also the means for SCXI and SCC configuration.

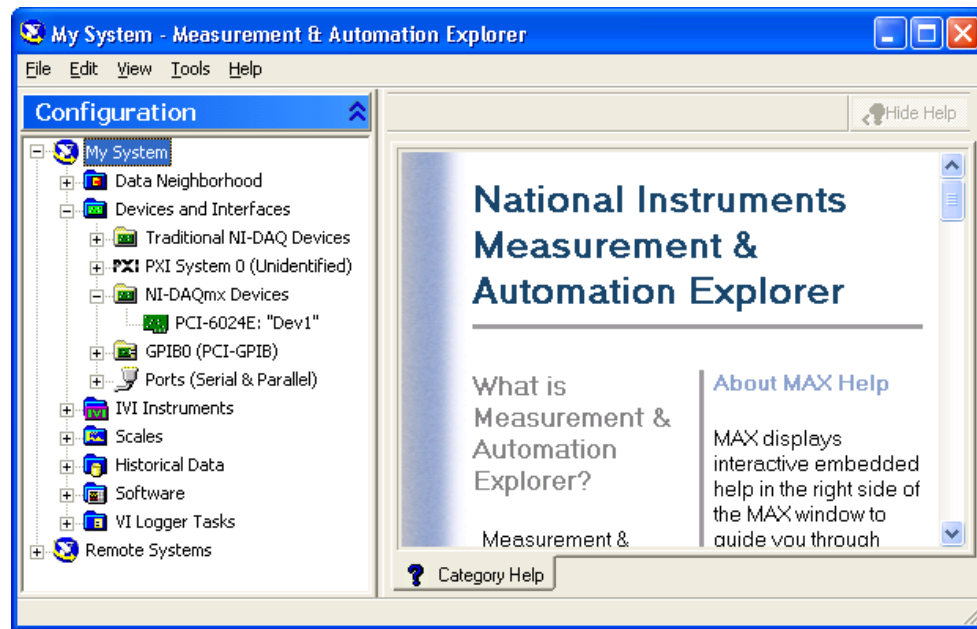

Figure 10.2

MAX detects all the National Instruments hardware including the GPIB interface. Refer to Instrument Control (Section 11.2), for more information about GPIB.

The device parameters that you can set using the configuration utility depend on the device. MAX saves the logical device number and the configuration parameters in the Windows Registry.

The plug and play capability of Windows automatically detects and configures switchless DAQ devices, such as the PCI-6024E. When you install a device in the computer, the device is automatically detected.

10.1.3 Channel and Task Configuration

In Traditional NI-DAQ you can configure a set of **virtual channels**, or a collection of property settings that include a physical channel, the type of measurement or generation specified in the channel name, and scaling information. In Traditional NI-DAQ and earlier versions, virtual channels are a simple method to remember which channels are used for different measurements. NI-DAQmx **channels** are similar to the virtual channels of Traditional NI-DAQ.

NI-DAQmx also includes **tasks** that are integral to the API. A **task** is a collection of one or more channels and the timing, triggering, and other properties that apply to the task itself. A task represents a measurement or generation you want to perform.

Channels created only inside a task are local. Channels defined outside a task are global and can be used separately. Configuring virtual channels is optional in Traditional NI-DAQ and earlier versions but is integral to every measurement you take in NI-DAQmx. In Traditional NI-DAQ, you configure virtual channels in MAX. In NI-DAQmx, you can configure virtual channels either in MAX or in a program, and you can configure channels as part of a task or separately.

10.2 Measurement & Automation Explorer (Windows Only)

Exercise 10.1:

10.2.1 Examining the DAQ Device Settings

1. Launch MAX by double-clicking the icon on the desktop or by selecting Tools>>Measurement & Automation Explorer in LabVIEW. The utility searches the computer for installed National Instruments hardware and displays the information.
2. Expand the Devices and Interfaces section to view the installed National Instruments devices. Figure 10.3 shows the PCI-6024E and a PCI-GPIB device.

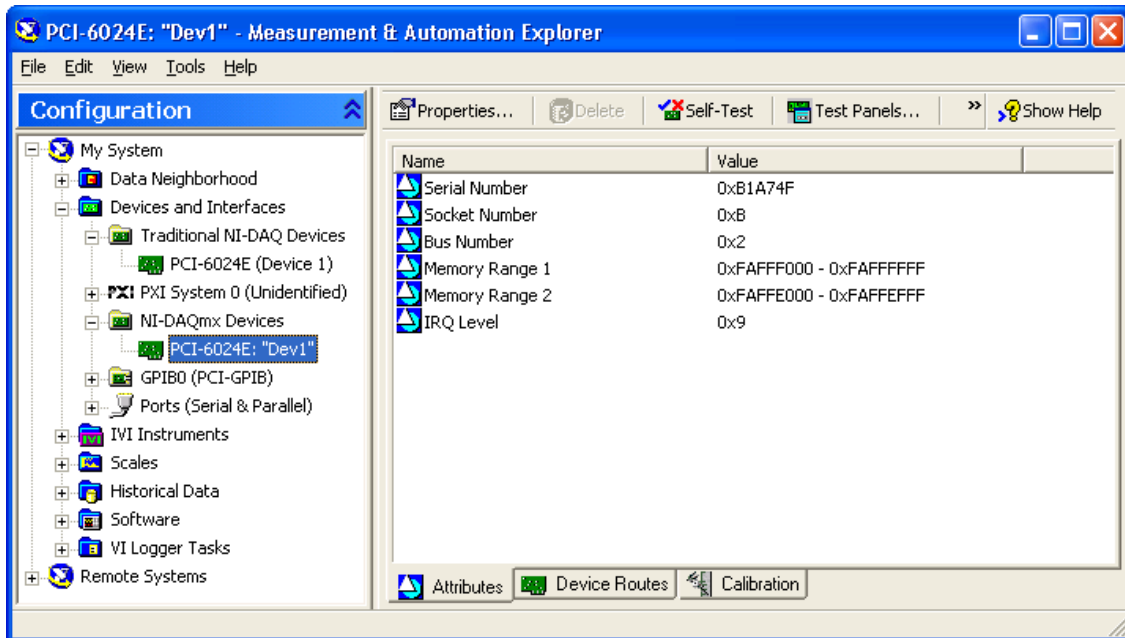

Figure 10.3

MAX displays the National Instruments hardware and software in the computer. The device number appears in quotes following the device name. The Data Acquisition VIs use this device number to determine which device performs DAQ operations. MAX also displays the attributes of the device such as the system resources that are being used by the device.

NOTE: You might have a different device installed, and some of the options shown might be different. Click the Show Help/Hide Help button in the top right corner of MAX to hide the online help and show the DAQ device information.

3. The Device Routes (Figure 10.4) tab provides detailed information about the internal signals that can be routed to other destinations on the device. This is a powerful resource that gives you a visual representation of the signals that are available to

provide timing and synchronization with components that are on the device and other external devices.

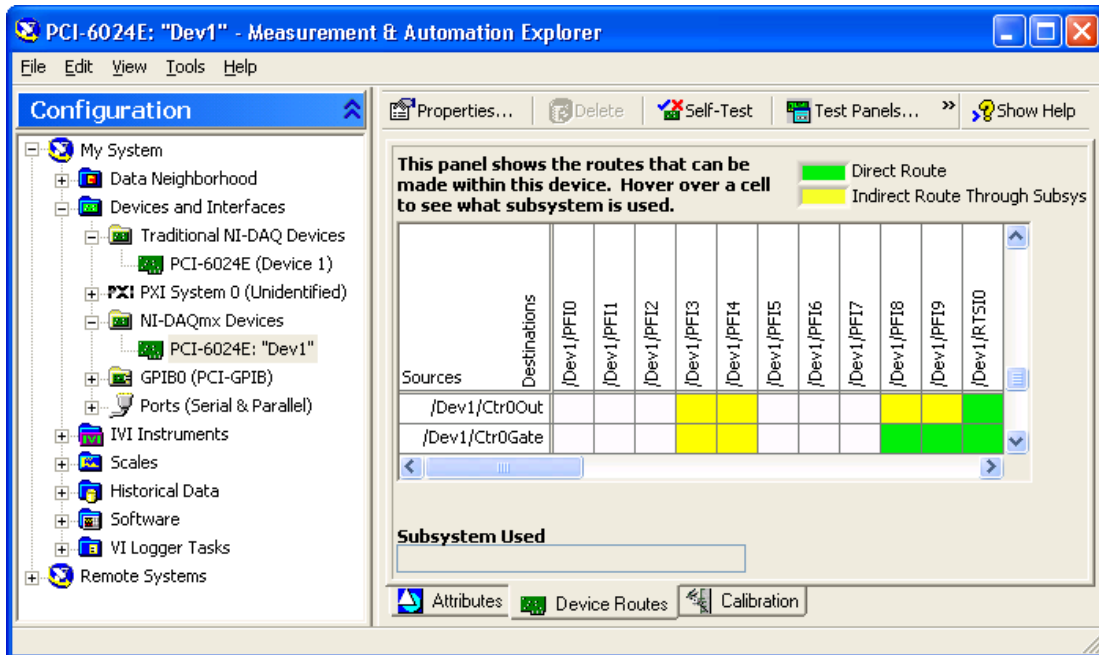

Figure 10.4

4. The Calibration (Figure 10.5) tab provides information about the last time the device was calibrated both internally and externally.

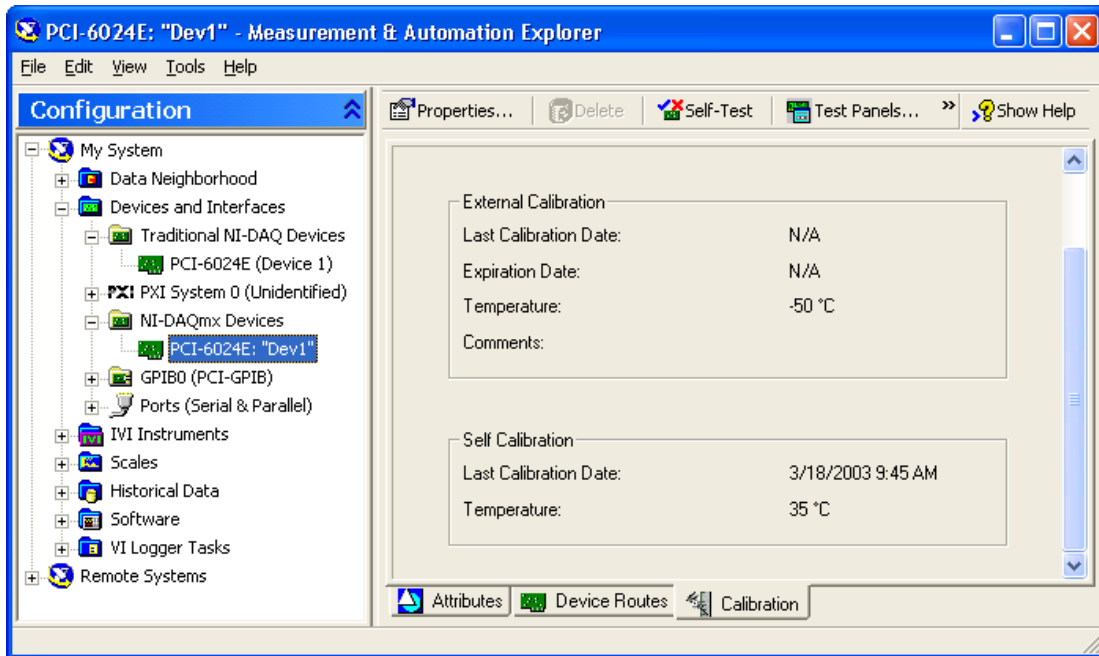

Figure 10.5

5. Right-click the NI-DAQmx device in the configuration tree and select Self Calibrate to calibrate the DAQ device using a precision voltage reference source and update the built-in calibration constants. When the device has been calibrated, the Self Calibration information updates in the Calibration tab.

10.2.2 Testing the DAQ Device Components

1. Click the Self-Test button to test the device. This tests the system resources assigned to the device. The device should pass the test because it is already configured.
2. Click the Test Panels button to test the individual functions of the DAQ device, such as analog input and output. The Test Panels dialog box appears.
 - (a) Use the Analog Input tab to test the various analog input channels on the DAQ device. Channel Dev1/ai0 is connected to the temperature sensor on the DAQ Signal Accessory. Click the Start button to acquire data from analog input channel 0. Place your finger on the sensor to see the voltage rise. You also can move the Noise switch to On on the DAQ Signal Accessory to see the signal change in this tab. When you are finished, click the Stop button.
 - (b) Click the Analog Output tab to set up a single voltage or sine wave on one of the DAQ device analog output channels. Change the Output Mode to Sinewave Generation and click the Start button. LabVIEW generates a continuous sine wave on analog output channel 0.
 - (c) On the external DAQ Signal Accessory box, wire Analog Out Ch0 to Analog In Ch1.

- (d) Click the Analog Input tab and change the channel to Dev1/ai1. Click the Start button to acquire data from analog input channel 1. LabVIEW displays the sine wave from analog output channel 0.
- (e) Click the Digital I/O tab to test the digital lines on the DAQ device. Set lines 0 through 3 as output and toggle the Logic Level checkboxes. As you toggle the boxes, the LEDs on the DAQ signal accessory turn on or off. The LEDs use negative logic.
- (f) Click the Counter I/O tab to determine if the DAQ device counter/timers are functioning properly. To verify counter/timer operation, change the Counter Mode tab to Edge Counting and click the Start button. The Counter Value increments rapidly. Click Stop to stop the counter test.
- (g) Click the Close button to close the Test Panel and return to MAX.

3. Close MAX by selecting File»»Exit.

10.3 Data Acquisition in LabVIEW

The LabVIEW Data Acquisition VIs are located on the Data Acquisition palette and the DAQmx - Data Acquisition palette. The Data Acquisition palette contains the traditional NI-DAQ VIs. The DAQmx - Data Acquisition palette contains the VIs for NI-DAQmx.

The DAQmx - Data Acquisition palette contains all of the VIs necessary to perform analog I/O, digital I/O, and counter/timer operations. The VIs are organized so that the most common operations can be performed using the VIs. You can configure a task to perform a very specific function by using the Property Nodes in the palette. Many applications that do not require advanced timing and synchronization can be performed by using the DAQ Assistant Express VI. This course describes the use of the DAQ Assistant Express VI to perform data acquisition. For more information on using all the features of NI-DAQmx, refer to the *NI-DAQmx Help* or attend the *LabVIEW Data Acquisition and Signal Conditioning* course.



The DAQ Assistant Express VI allows you to easily configure the data acquisition device. When you place the DAQ Assistant Express VI on the block diagram, a dialog box (Figure 10.6) appears where you configure a local task to perform a specific measurement function. Creating a local task allows you to specify the exact type of measurement to take.

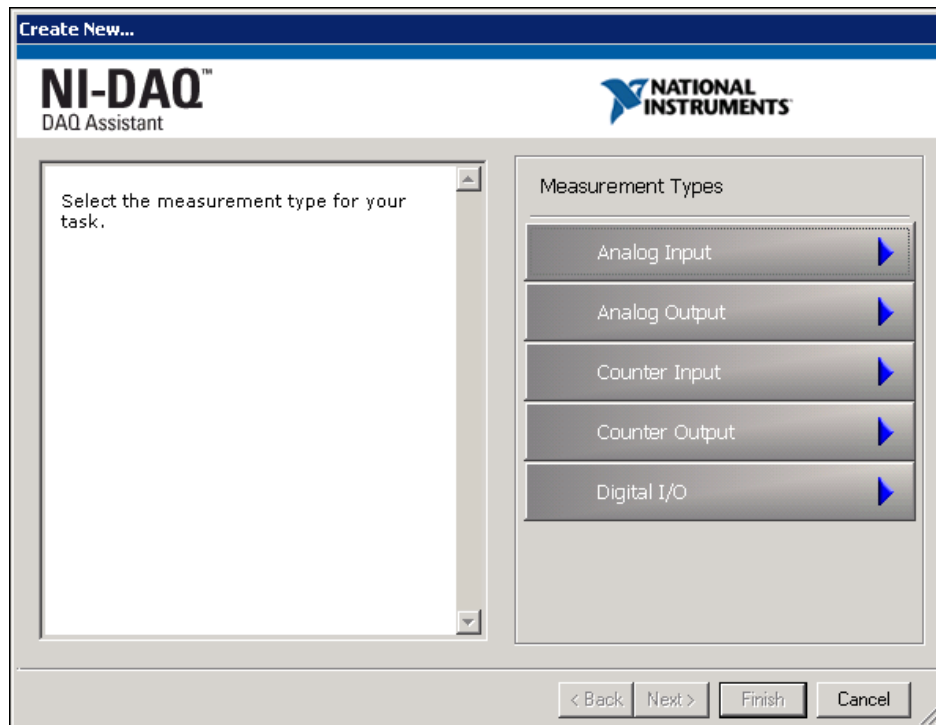

Figure 10.6

After you create a task, the information for the local task is stored in the DAQ Assistant Express VI.

You can reconfigure the DAQ Assistant Express VI by double-clicking the VI and creating a new task.

10.4 Analog Input

Use analog input to perform analog-to-digital (A/D) conversions.

The available analog input measurement types (Figure 10.7) for a task are voltage, temperature, strain, current, resistance, or frequency.

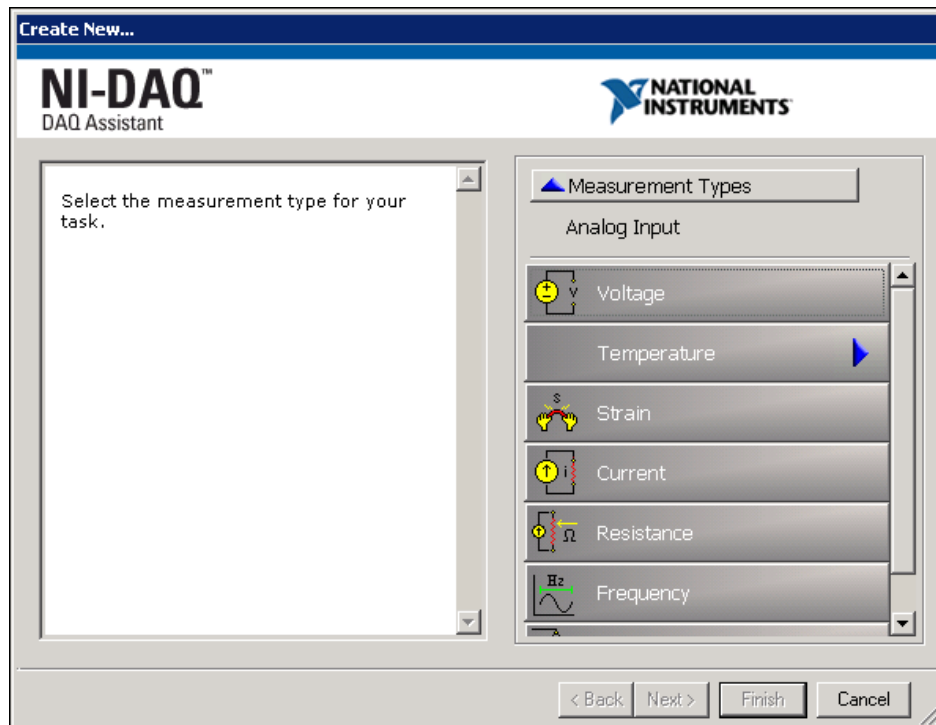

Figure 10.7

Each measurement type has its own characteristics, such as resistor values for current measurements or strain gauge parameters for strain measurements.

10.4.1 Task Timing

When performing analog input, the task can be timed to Acquire 1 Sample (Section 10.4.1.1), Acquire n Samples (Section 10.4.1.2), or Acquire Continuously (Section 10.4.1.3).

10.4.1.1 Acquire 1 Sample

Acquiring a single sample is an on-demand operation. In other words, NI-DAQmx acquires one value from an input channel and immediately returns the value. This operation does not require any buffering or hardware timing. For example, if you periodically monitor the fluid level in a tank, you would acquire single data points. You can connect the transducer that produces a voltage representing the fluid level to a single channel on the measurement device and initiate a single-channel, single-point acquisition when you want to know the fluid level.

10.4.1.2 Acquire n Samples

One way to acquire multiple samples for one or more channels is to acquire single samples in a repetitive manner. However, acquiring a single data sample on one or more channels over and over is inefficient and time consuming. Moreover, you do not have accurate control over the time between each sample or channel. Instead you can use hardware timing, which uses a buffer in

computer memory, to acquire data more efficiently. Programmatically, you need to include the timing function and specify the sample rate and the sample mode (finite). As with other functions, you can acquire multiple samples for a single channel or multiple channels.

With NI-DAQmx, you also can gather data from multiple channels. For instance, you might want to monitor both the fluid level in the tank and the temperature. In such a case, you need two transducers connected to two channels on the device.

10.4.1.3 Acquire Continuously

If you want to view, process, or log a subset of the samples as they are acquired, you need to continually acquire samples. For these types of applications, set the sample mode to continuous.

10.4.2 Task Triggering

When a device controlled by NI-DAQmx does something, it performs an action. Two very common actions are producing a sample and starting a waveform acquisition. Every NI-DAQmx action needs a stimulus or cause. When the stimulus occurs, the action is performed. Causes for actions are called **triggers**. The start trigger starts the acquisition. The reference trigger establishes the reference point in a set of input samples. Data acquired up to the reference point is pretrigger data. Data acquired after the reference point is posttrigger data.

10.5 Voltmeter VI

Exercise 10.2:

10.5.1 Front Panel

1. Open a blank VI and build the front panel shown in Figure 10.8.

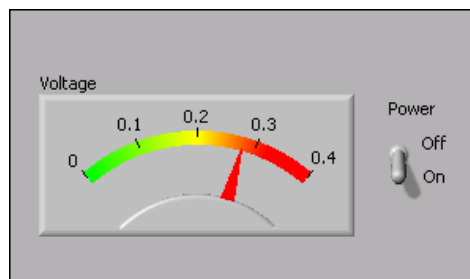

Figure 10.8

- (a) Place the Meter, located on the Controls»Numeric Indicators palette, on the front panel. Configure the meter scale for 0.0 to 0.4. Use the Labeling tool to double-click 10.0 and type 0.4. You might need to enlarge the meter to display the scale as shown in the example (Figure 10.8).
- (b) Place a Vertical Toggle Switch, located on the Controls»Buttons & Switches palette, on the front panel. Configure the toggle switch to a default value of False and a mechanical action of Latch When Pressed.
- (c) Create two free labels, Off and On, using the Labeling tool.

10.5.2 Block Diagram

1. Build the block diagram shown in Figure 10.9.

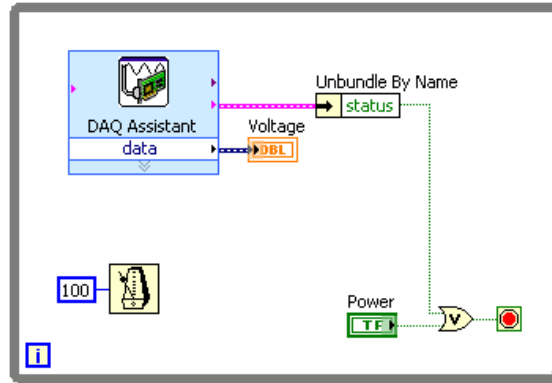

Figure 10.9



- (a) Place the DAQ Assistant Express VI located on the Functions»Input palette, on the block diagram. Configure this VI to read an analog input channel and return the voltage.
- Select Analog Input»Voltage for the measurement to make.
 - Select Dev1»ai0 for the physical channel.
 - Click the Finish button.
 - The Analog Input Voltage Task dialog box appears. Configure the Task Timing to Acquire 1 Sample.
 - Click the OK button to close the Analog Input Voltage Task Configuration dialog box. This saves the settings specified for the task in the DAQ Assistant Express VI.



- (b) Place the Wait Until Next ms Multiple function, located on the Functions»All Functions»Time & Dialog palette, on the block diagram. Right-click the input and select Create Constant from the shortcut menu. Type 100 in the constant to cause the loop to execute every 100 ms.



- (c) Place the Unbundle by Name function, located on the Functions»All Functions»Cluster palette, on the block diagram. Use this function to access the status from the error cluster.



- (d) Place the Or function, located on the Functions»Arithmetic & Comparison»Express Boolean palette, on the block diagram. This function stops the loop if an error occurs or the user clicks the power switch on the front panel.

2. Save the VI as Voltmeter.vi in the C:\Exercises\LabVIEW Basics I directory. You will use this VI later in the course.

3. Display the front panel and run the VI. The meter displays the voltage the temperature sensor outputs. Place your finger on the temperature sensor and notice that the voltage increases.

10.5.3 Scales

The temperature sensor on the DAQ Signal Accessory outputs the voltage in degrees Celsius, scaled by 100. In order to convert the voltage into degrees Celsius, it is necessary to multiply the voltage by 100. You could multiply the output of the DAQ Assistant Express VI by 100, or configure the DAQ Assistant Express VI to automatically scale the voltage. Using the capabilities that exist within the VI reduces block diagram clutter.

1. Double-click the DAQ Assistant to display the Analog Input Voltage Task Configuration dialog box.
2. Select Create New in the Custom Scaling pull-down menu.
3. Select Linear and name the scale temperature. Click the Finish button.
4. A dialog box appears where you can scale the data by a multiplier and an offset.
 - (a) Set the slope to 100 and the Scaled Units to Celsius.
 - (b) Click the OK button to close the dialog box.
5. In the Analog Input Voltage Task Configuration dialog box, set the minimum input range to 0, set the maximum input range to 100, and click the OK button to return to the block diagram.
6. Run the VI. The temperature displays in the meter. The temperature values are 100 times greater than the voltage values. Change the meter scale to see the correct values.
7. Stop the VI. Save the VI but do not close it. You will use the VI in the Measurement Averaging VI (Section 10.6) exercise.

10.6 Measurement Averaging VI

Exercise 10.3:

1. Run the Voltmeter VI (Section 10.5).
2. Introduce noise into the temperature measurement by changing the Temp Sensor Noise switch on the DAQ Signal Accessory to the ON position. The measurements begin to fluctuate with noise spikes.

10.6.1 Block Diagram

1. Stop the VI and display the block diagram (Figure 10.10). Modify the block diagram to calculate the average of 100 measurements.

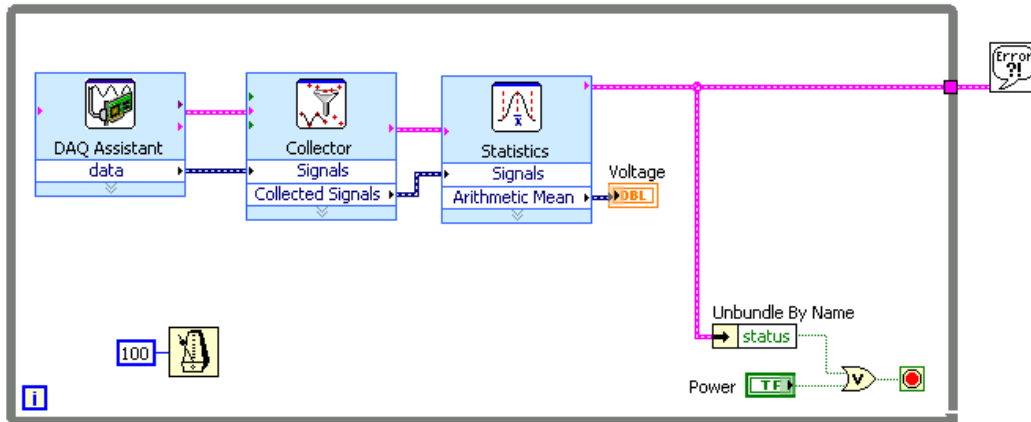



Figure 10.10

2.  Place the Collector Express VI located on the Functions>>Signal Manipulation palette, on the block diagram. This Express VI creates an internal buffer to store the individual points. When the maximum number of input points is collected, the Express VI discards the oldest points and adds the newest points. In the Configure Collector dialog box that appears, set the Maximum number of samples to 100. Click the OK button to close the dialog box.
3.  Place the Statistics Express VI, located on the Functions>>Analysis palette, on the block diagram. In the Configure Statistics dialog box that appears, place a checkmark in the Arithmetic Mean checkbox to perform averaging on the collected data. Click the OK button to close the dialog box.
4. Select File>>Save As to save the VI as Measurement Averaging.vi in the C:\Exercises\LabVIEW Basics I directory.
5. Display the front panel and run the VI. Notice that the noise spikes are reduced when the Temp Sensor Noise switch is turned on.
6. Stop and close the VI.

10.7 Data Logging

It is often necessary to permanently store data acquired from the DAQ device. Remember the following important considerations when planning to store data to a file.

- Not all data logging applications use LabVIEW to process and analyze the stored data. Consider which applications will need to read the data.
- The data storage format defines which applications can read the file. Since LabVIEW contains standard file operation functions that exist in other languages, the programmer has complete control over the data logging process.

LabVIEW includes the ability to create a LabVIEW measurement file, an ASCII text file that can be read by a spreadsheet, or a text editor. The LabVIEW measurement file is easy to create in LabVIEW, and easy to read in LabVIEW or other applications.

The Write LabVIEW Measurement File Express VI located on the Functions»Output palette writes signals to a LabVIEW measurement file. When you place this Express VI on the block diagram, a configuration dialog box appears where you can specify how to store the file.

The Read LabVIEW Measurement File Express VI located on the Functions»Input palette reads signals in a LabVIEW measurement file. This Express VI reads data one point at a time, so it is necessary to place this Express VI in a loop.

10.8 Simple Data Logger VI

Exercise 10.4:

10.8.1 Simple Data Logger Block Diagram

1. Open the Measurement Averaging VI located in the C:\Exercises\LabVIEW Basics I directory.
2. Modify the block diagram to log the acquired data as shown in Figure 10.11.

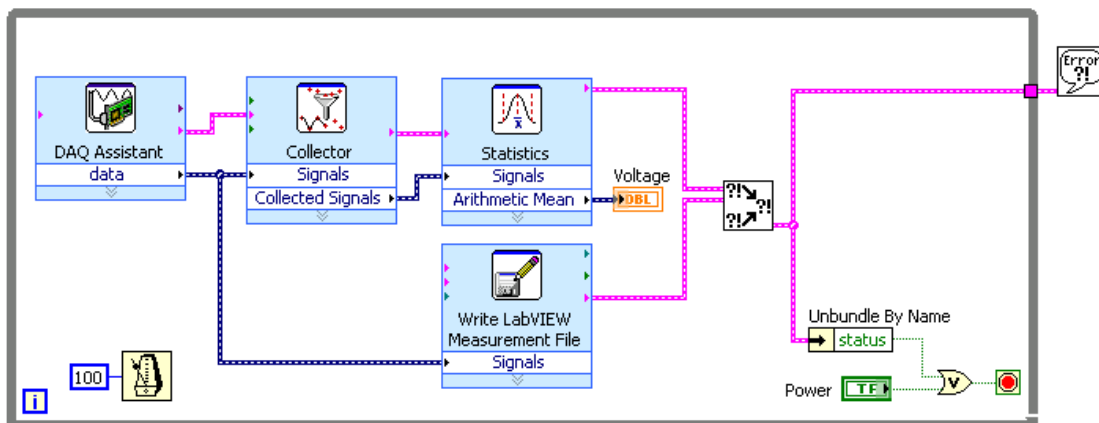

Figure 10.11



Place the Write LabVIEW Measurement File Express VI, located on the Functions»Output palette, on the block diagram. This Express VI stores the data acquired from the DAQ device. In the Configure Write LabVIEW Measurement File dialog box that appears, set the following options:

- (a) Set the Action to Ask user to choose file for the filename.
- (b) Set the Segment Headers to One header only to provide a header for all of the data. The header contains information about the sampling rate and the time when the sample was taken.
- (c) Set X Value Columns to One column per channel to provide a table of data that can be read by any spreadsheet editor or an ASCII text file editor.

- (d) Set the Delimiter to Tab to make it easy for a spreadsheet editor to determine where a column of data starts in the file.
- (e) Click the OK button to close the dialog box.



Place the Merge Errors VI, located on the Functions»All Functions»Time & Dialog palette, on the block diagram. It is important to catch errors with both DAQ and file I/O, and because the code has a parallel structure it is necessary to merge the errors from all of the parallel operations to determine if the code is functioning properly.

3. Select File»Save As to save the VI as Simple Data Logger.vi in the C:\Exercises\LabVIEW Basics I directory.
4. Run the VI. A filename prompt appears. Name the file logger.lvm in the C:\Exercises\LabVIEW Basics I directory.
5. Stop and close the VI.

10.8.2 Simple Data Reader Front Panel

1. Open a blank VI and build the front panel shown in Figure 10.12 by placing a waveform chart, located on the Controls»Graph Indicators palette, on the front panel.

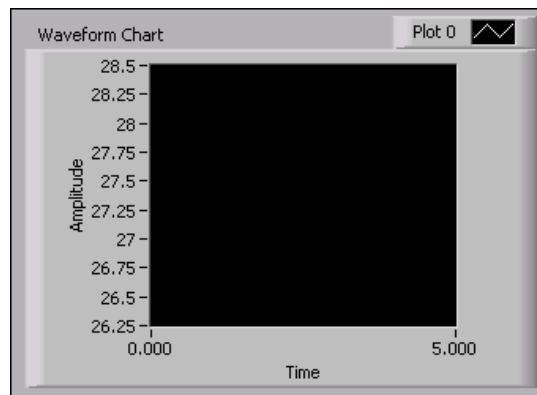

Figure 10.12

10.8.3 Block Diagram

1. Build the block diagram shown in Figure 10.13.

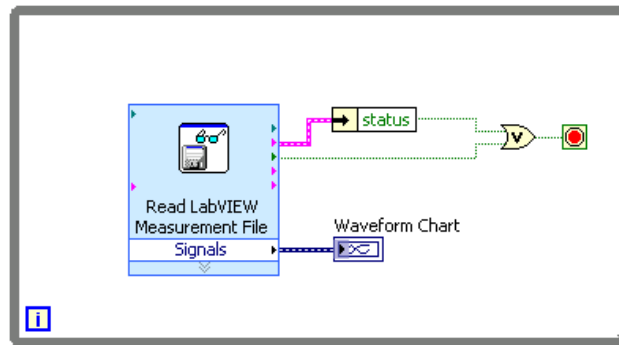

Figure 10.13



- (a) Place the Read LabVIEW Measurement File Express VI, located on the Functions>>Input palette, on the block diagram. Because this Express VI reads data located in a LabVIEW measurement file one data point at a time, it must be placed in a loop. In the Configure Read LabVIEW Measurement File dialog box that appears, set the following options:

- In the Action section, place a checkmark in the Ask user to choose file checkbox.
- Set the Segment Size to Retrieve segments of original size so that all the data stored in the file is retrieved.
- Set Time Stamps to Relative to start of measurement. Because the dynamic data type stores information about the signal timing, this setting aligns the data with the time of the measurement.
- In the Generic Text File section, remove the checkmark from the Read generic text files checkbox because the data is stored in a LabVIEW measurement file.
- Click the OK button to close the dialog box.



- (b) Place the Unbundle by Name function, located on the Functions>>All Functions>>Cluster palette, on the block diagram.



- (c) Place the Or function, located on the Functions>>Arithmetic & Comparison>>Express Boolean palette, on the block diagram.

- (d) Wire the EOF? output of the Read LabVIEW Measurement File function to the Or function. Wire the status output of the error cluster to the second input of the Or function. This stops the While Loop when the entire LabVIEW Measurement File has been read or when an error occurs.

2. Save the VI as Simple Data Reader.vi in the C:\Exercises\LabVIEW Basics I directory.
3. Display the front panel, and run the VI. In the filename prompt that appears, select the logger.lvm file that you created earlier (pg 202).
4. The data that was stored in the LabVIEW Measurement File appears in the waveform chart.

NOTE: You might need to rescale or autoscale the y-axis of the waveform chart to display the data.

5. Close the Simple Data Reader VI.

10.9 Analog Output

Use analog output to perform digital-to-analog (D/A) conversions. The available analog output types (Figure 10.14) for a task are voltage and current.

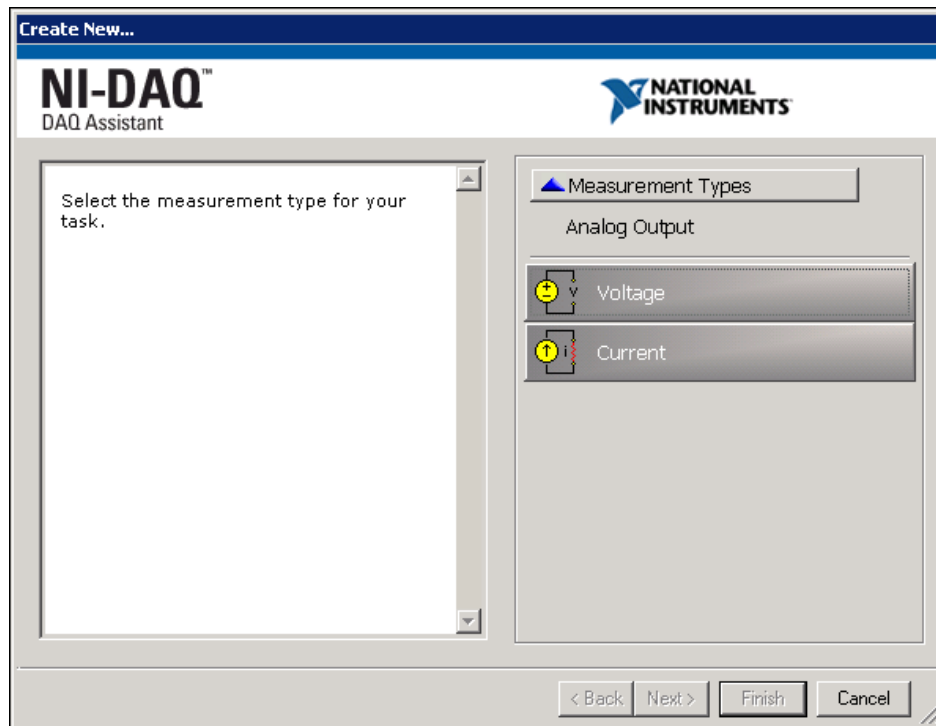

Figure 10.14

To perform a voltage or current task, a compatible device must be installed that can generate that form of signal.

10.9.1 Task Timing

When performing analog output, the task can be timed to Generate 1 Sample (Section 10.9.1.1), Generate n Samples (Section 10.9.1.2), or Generate Continuously (Section 10.9.1.3).

10.9.1.1 Generate 1 Sample

Use single updates if the signal level is more important than the generation rate. For example, generate one sample at a time if you need to generate a constant, or DC, signal. You can use software timing to control when the device generates a signal.

This operation does not require any buffering or hardware timing. For example, if you need to generate a known voltage to stimulate a device, a single update would be an appropriate task.

10.9.1.2 Generate n Samples

One way to generate multiple samples for one or more channels is to generate single samples in a repetitive manner. However, generating a single data sample on one or more channels over and over is inefficient and time consuming. Moreover, you do not have accurate control over the time between each sample or channel. Instead, you can use hardware timing, which uses a buffer in computer memory to generate samples more efficiently.

You can use software timing or hardware timing to control when a signal is generated. With software timing, the rate at which the samples are generated is determined by the software and operating system instead of by the measurement device. With hardware timing, a TTL signal, such as a clock on the device, controls the rate of generation. A hardware clock can run much faster than a software loop. A hardware clock is also more accurate than a software loop.

NOTE: Some devices do not support hardware timing. Consult the device documentation if you are unsure if the device supports hardware timing.

Programmatically, you need to include the timing function, specifying the sample rate and the sample mode (finite). As with other functions, you can generate multiple samples for a single channel or multiple channels.

Use Generate n Samples if you want to generate a finite time-varying signal, such as an AC sine wave.

10.9.1.3 Generate Continuously

Continuous generation is similar to Generate n Samples, except that an event must occur to stop the generation. If you want to continuously generate signals, such as generating a non-finite AC sine wave, set the timing mode to continuous.

10.9.2 Task Triggering

When a device controlled by NI-DAQmx does something, it performs an action. Two very common actions are producing a sample and starting a generation. Every NI-DAQmx action needs a stimulus or cause. When the stimulus occurs, the action is performed. Causes for actions are called triggers. The start trigger starts the generation. The reference trigger is not supported for analog output tasks.

10.10 Voltage Output VI

Exercise 10.5:

1. Connect Analog Out CH0 to Analog In CH1 on the DAQ Signal Accessory.

10.10.1 Front Panel

1. Open the Voltage Output VI located in the C:\Exercises\LabVIEW Basics I directory. The front panel (Figure 10.15) is already built.

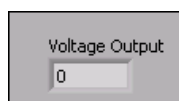

Figure 10.15

Voltage Output displays the current voltage output.

10.10.2 Block Diagram

1. Display and examine the block diagram (Figure 10.16).

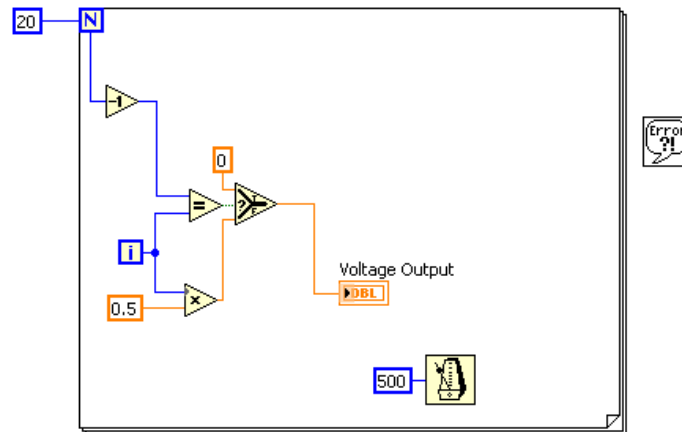



Figure 10.16

-  The Wait Until Next ms Multiple function located on the Functions>>All Functions>>Time & Dialog palette causes the For Loop to execute every 500 ms.
-  The Select VI located on the Functions>>Arithmetic & Comparison>>Express Comparison palette checks if the loop is in its last iteration. If the loop is in its last iteration, then the DAQ device outputs 0 volts. This is a good technique to reset the output voltage to a known level. It is always a good idea to reset the output voltage to something that will not damage a device that is connected to the DAQ device.

2. Modify the block diagram as shown in Figure 10.17.

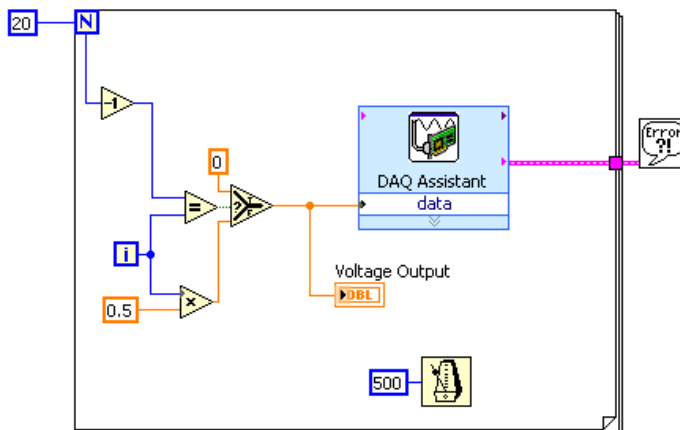

Figure 10.17



Place the DAQ Assistant Express VI, located on the Functions>>Output palette, in the For Loop. Complete the following steps to configure this Express VI to generate an analog output voltage.

- (a) Select Analog Output>>Voltage for the measurement to make.
- (b) Select Dev1>>ao0 for the physical channel and click the Finish button.
- (c) In the Analog Output Voltage Task Configuration dialog box that appears, configure the Task Timing to Generate 1 Sample. Change the output range minimum to 0 and maximum to 10.
- (d) Click the OK button to close the Analog Output Voltage Task Configuration dialog box. This saves the settings specified for the task in the DAQ Assistant Express VI.

3. Save the VI.

4. Close the block diagram but leave the front panel open.

10.10.3 Front Panel

1. Open the Voltmeter (Section 10.5) VI.
2. Configure the meter scale minimum to 0.0 and maximum to 10.0.

10.10.4 Block Diagram

1. Display the block diagram for the Voltmeter VI and double-click the DAQ Assistant Express VI to open the Analog Input Voltage Task Configuration dialog box.
2. Right-click Voltage in the Channel List section and select Change Physical Channel. Select ai1 for the channel because you wired the DAQ signal accessory to output a voltage on Analog Out CH0 and acquire the voltage from Analog In CH1.
3. Select No Scale from the Custom Scaling pull-down menu.

4. Change the voltage range to 0 to 10.
5. Click the OK button to close the dialog box.
6. Display the front panel and run the Voltmeter VI.
7. To acquire and display the voltage output, run the Voltage Output VI. The Voltage Output (Figure 10.18) VI outputs the voltage in 0.5 V increments from 0 to 9.5 V. When the For Loop executes its last iteration, the VI outputs 0 V to reset the analog output channel.

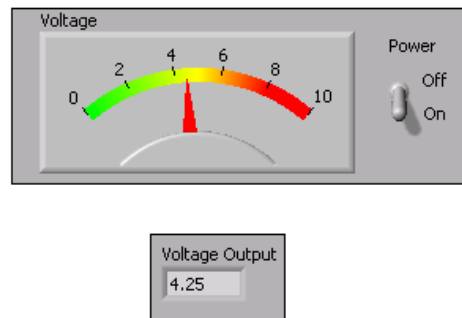

Figure 10.18

8. Close both VIs.

10.11 Counters

A counter is a digital timing device. You typically use counters for event counting, frequency measurement, period measurement, position measurement, and pulse generation.

A counter contains the following four main components:

- **Count Register** - Stores the current count of the counter. You can query the count register with software.
- **Source** - An input signal that can change the current count stored in the count register. The counter looks for rising or falling edges on the source signal. Whether a rising or falling edge changes the count is software selectable. The type of edge selected is referred to as the active edge of the signal. When an active edge is received on the source signal, the count changes. Whether an active edge increments or decrements the current count is also software selectable.
- **Gate** - An input signal that determines if an active edge on the source will change the count. Counting can occur when the gate is high, low, or between various combinations of rising and falling edges. Gate settings are made in software.
- **Output** - An output signal that generates pulses or a series of pulses, otherwise known as a pulse train.

When you configure a counter for simple event counting, the counter increments when an active edge is received on the source. In order for the counter to increment on an active edge, the counter must be armed or started. A counter has a fixed number it can count to as determined by the resolution of the counter. For example, a 24-bit counter can count to:

$$2^{\text{Counter Resolution}} - 1 = 2^{24} - 1 = 16,777,215$$

When a 24-bit counter reaches the value of 16,777,215, it has reached the terminal count. The next active edge will force the counter to roll over and start at 0.

10.12 Simple Event Counting VI

Exercise 10.6:

10.12.1 Front Panel

1. Open a blank VI and build the front panel shown in Figure 10.19.



Figure 10.19

10.12.2 Block Diagram

1. Build the block diagram shown in Figure 10.20.

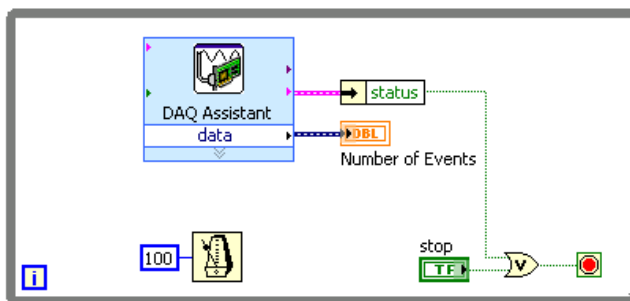

Figure 10.20



Place the DAQ Assistant Express VI, located on the Functions>>Input palette, in a While Loop. Complete the following steps to configure the counter to perform event counting.

- (a) Select Counter Input>>Edge Count for the measurement to make.
- (b) Select Dev1>>ctr0 for the physical channel.
- (c) In the Counter Input Edge Count Task Configuration dialog box that appears, leave the settings as they are. The default settings define the source of the counter as being Programmable Function Input (PFI) 8, which is the default source for counter 0. The DAQ Signal Accessory connects counter 0 source input to PFI 8.

- (d) Click the OK button to close the Counter Input Edge Count Task Configuration dialog box. This saves all the settings specified for the task in the DAQ Assistant Express VI.
2. Save the VI as Simple Event Counting.vi in the C:\Exercises\LabVIEW Basics I directory.
3. On the DAQ Signal Accessory, wire the A output of the quadrature encoder to the SOURCE input of counter 0.
4. Run the VI. Rotate the quadrature encoder knob on the DAQ Signal Accessory. Notice that the Number of Events indicator increments as you rotate the knob. The quadrature encoder knob produces pulses as you rotate the knob. The counter counts these pulses.
5. Stop the VI.
6. Double-click the DAQ Assistant Express VI, and change the Count Direction pull-down menu to Externally Controlled. Click the OK button to close the configuration dialog box. The DAQ Signal Accessory internally connects phase B of the quadrature encoder to the Up/Down line for counter 0. This can be used to determine the direction the knob has turned.
7. Run the VI. Rotate the quadrature encoder knob on the DAQ Signal Accessory. Notice that the Number of Events indicator decrements when you rotate the knob clockwise, and increments when you rotate the knob counterclockwise.
8. Save and close the VI.

10.13 Digital I/O

Measuring and generating digital values is used in a variety of applications, including controlling relays and monitoring alarm states. Generally, measuring and generating digital values is used in laboratory testing, production testing, and industrial process monitoring and control.

Digital I/O can read from or write to a line or an entire digital port, which is a collection of lines.

You can use the digital lines in a DAQ device to acquire a digital value. This acquisition is based on software timing. On some devices, you can configure the lines individually to either measure or generate digital samples. Each line corresponds to a channel in the task.

You can use the digital port(s) in a DAQ device to acquire a digital value from a collection of digital lines. This acquisition is based on software timing. You can configure the ports individually to either measure or generate digital samples. Each port corresponds to a channel in the task.

10.14 Digital Example VI

Exercise 10.7:

NOTE: The LEDs use negative logic. That is, writing a 1 to the LED digital line turns off the LED. Writing a 0 to the LED digital line turns on the LED.

1. Open the Digital Example VI, located in the C:\Exercises\LabVIEW Basics I directory, and modify the block diagram as shown in Figure 10.21.

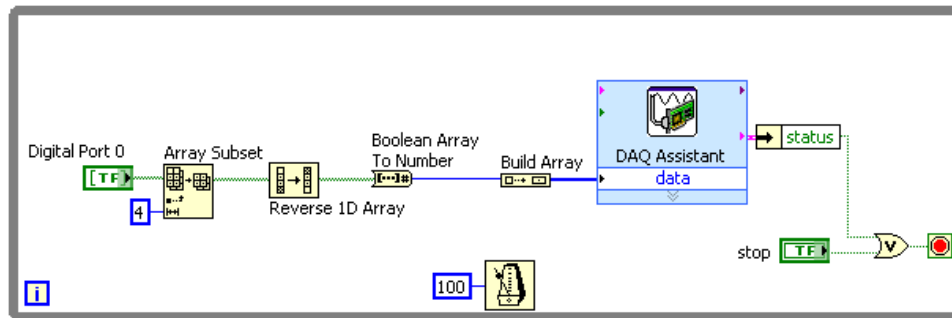

Figure 10.21



Place the DAQ Assistant Express VI, located on the Functions>>Input palette, in the While Loop. Complete the following steps to configure the counter to perform event counting.

- (a) Select Digital I/O>>Port Output for the measurement to make.
- (b) Select Dev1>>port0 for the physical channel and click the Finish button.
- (c) In the Digital Output Port Task Configuration dialog box that appears, select Invert All Lines In Port because the LEDs use negative logic.
- (d) Click the OK button to close the configuration dialog box. All of the settings specified for the task are saved internally in the DAQ Assistant VI.



Place the Build Array function, located on the Functions>>All Functions>>Array palette, on the block diagram. Wire the Build Array function to the DAQ Assistant. Complete the wiring of the block diagram. The Boolean buttons on the front panel are stored in an array to simplify the code. The Array Subset function extracts only the first four elements in the array. The output of the array subset needs to be reversed because element 0 of the array is the most significant bit. The array is then converted to a number with the Boolean Array to Number function, and converted into an array of one element. This value is passed to the DAQ Assistant Express VI to write that value to the port.

2. Save the VI.
3. Display the front panel and run the VI. Turn the Boolean LEDs on and off and observe the changes on the DAQ Signal Accessory.
4. Stop and close the VI.

10.15 Summary, Tips, and Tricks on Data Acquisition and Waveforms

- MAX is the primary configuration and testing utility that is available for the DAQ device.
- The DAQ Assistant is used to configure the DAQ device and perform data acquisition.
- Most programs can use the DAQ Assistant. For programs that require advanced timing and synchronization, use the VIs that come with NI-DAQmx.

- The DAQ Assistant can perform analog input, analog output, counter, and digital I/O and operations.

10.16 Additional Exercises for Data Acquisition and Waveforms

Exercise 10.8:

Build a VI that continuously measures temperature twice per second and displays the temperature on a waveform chart. If the temperature goes over a preset limit, the VI should turn on a front panel LED and LED 0 on the DAQ Signal Accessory. The LEDs on the box are labeled. The chart should plot both the temperature and limit.

Save the VI as Temp Monitor with LED.vi in the C:\Exercises\LabVIEW Basics I directory.

Chapter 11

Instrument Control

11.1 Instrument Control Overview

You are not limited to the type of instrument that you control if you choose industry-standard control technologies. You can use instruments from many different categories, including serial, GPIB, VXI, PXI, computer-based instruments, Ethernet, SCSI, CAMAC, and parallel port devices. This lesson describes the two most common instrument communication methods, GPIB and serial port communication.

You must consider the following issues with PC control of instrumentation:

- Type of connector (pinouts) on the instrument
- **Cables needed** - null-modem, number of pins, male/female
- **Electrical properties involved** - signal levels, grounding, cable length restrictions
- **Communication protocols used** - ASCII commands, binary commands, data format
- Software drivers available

11.2 GPIB Communication and Configuration

The **ANSI/IEEE Standard 488.1-1987**, also known as **General Purpose Interface Bus (GPIB)**, describes a standard interface for communication between instruments and controllers from various vendors, such as scanners and film recorders. It contains information about electrical, mechanical, and functional specifications. GPIB is a digital, 8-bit parallel communication interface with data transfer rates of 1 Mbyte/s and higher, using a three-wire handshake. The bus supports one System Controller, usually a computer, and up to 14 additional instruments. The ANSI/IEEE Standard 488.2-1992 extends IEEE 488.1 by defining a bus communication protocol, a common set of data codes and formats, and a generic set of common device commands.

GPIB instruments offer test and manufacturing engineers the widest selection of vendors and instruments for general-purpose to specialized vertical market test applications. GPIB instruments have traditionally been used as stand-alone benchtop instruments where measurements are taken by hand.

The GPIB is a 24-conductor parallel bus that consists of eight data lines, five bus management lines (ATN, EOI, IFC, REN, and SRQ), three handshake lines, and eight ground lines. The GPIB uses a byte-serial, asynchronous data transfer scheme. This means that whole bytes are sequentially handshaked across the bus at a speed that the slowest participant in the transfer determines. Because

the unit of data on the GPIB is a byte, the messages transferred are frequently encoded as ASCII character strings.

11.2.1 GPIB Addressing

All GPIB devices and interfaces must have a unique GPIB address between 0 and 30. Address 0 is normally assigned to the GPIB interface. The instruments on the GPIB can use addresses 1 through 30. GPIB devices can be talkers, listeners, or controllers. A talker sends out data messages. Listeners receive data messages. The controller, usually a computer, manages the flow of information on the bus. It defines the communication links and sends GPIB commands to devices. The GPIB VIs automatically handle the addressing and most other bus management functions.

11.2.2 Data Transfer Termination

You can terminate a GPIB data transfer in the following three ways:

- The GPIB includes a hardware line (EOI) that can be asserted with the last data byte. This is the preferred method.
- Place a specific end-of-string (EOS) character at the end of the data string itself. Some instruments use this method instead of or in addition to the EOI line assertion.
- The listener counts the bytes handshaked and stops reading when the listener reaches a byte count limit. This method is often used as a default termination method because the transfer stops on the logical OR of EOI, EOS (if used) in conjunction with the byte count. Thus, you typically set the byte count to equal or exceed the expected number of bytes to be read.

11.2.3 Restrictions

To achieve the high data transfer rate that the GPIB was designed for, you must limit the number of devices on the bus and the physical distance between devices. The following restrictions are typical:

- A maximum separation of 4 m between any two devices and an average separation of 2 m over the entire bus
- A maximum total cable length of 20 m
- A maximum of 15 devices connected to each bus, with at least two-thirds powered on

For high-speed operation, the following restrictions apply:

- All devices in the system must be powered on
- Cable lengths must be as short as possible with up to a maximum of 15 m of cable for each system
- There must be at least one equivalent device load per meter of cable

If you want to exceed these limitations, you can use a bus extender to increase the cable length or a bus expander to increase the number of device loads. You can order bus extenders and expanders from National Instruments.

NOTE: Refer to the National Instruments GPIB support Web site¹ for more information about GPIB.

¹<http://www.ni.com/support/gpibsupp.htm>

11.2.4 Software Architecture

The software architecture for GPIB instrument control using LabVIEW is similar to the architecture for DAQ. The GPIB interface includes a set of drivers. These drivers also are available on the LabVIEW CD and the majority of the drivers are available for download at <http://ni.com/support/gpib/versions.htm>². Always install the newest version of these drivers unless otherwise instructed in the release notes for either the GPIB interface or LabVIEW.

(Windows)

Use MAX to configure and test the GPIB interface. MAX interacts with the various diagnostic and configuration tools installed with the driver and also with the Windows Registry and Device Manager. The driver-level software is in the form of a DLL and contains all the functions that directly communicate with the GPIB interface. The Instrument I/O VIs and functions directly call the driver software.

11.2.4.1 Configuration Software (Windows)

NOTE: (*MAC OS and UNIX*) Refer to the GPIB interface documentation for information about configuring and testing the interface.

MAX is the configuration utility for National Instruments software and hardware. It also can execute system diagnostics, add new channels, interfaces, and virtual channels, and view devices and instruments connected to the system.

Open MAX by double-clicking the icon on the desktop or by selecting Tools»Measurement & Automation Explorer in LabVIEW.

The Configuration pane of MAX includes the following sections under My System:

- **Data Neighborhood** - Use this section to create and test virtual channels, aliases, and tags to channels or measurements configured in Devices and Interfaces.
- **Devices and Interfaces** - Use this section to configure resources and other physical properties of devices and interfaces and to view attributes of one or multiple devices, such as serial numbers.
- **IVI Instruments** - Use this section to name an IVI virtual instrument, modify its properties, and swap IVI instruments.
- **Scales** - Use this section to set up simple operations to perform on data, such as scaling the temperature reading from the DAQ Signal Accessory from volts to degrees Celsius.
- **Historical Data** - Use this section to access databases and logged data.
- **Software** - Use this section to determine which National Instruments drivers and application software are installed and their version numbers.
- **VI Logger Tasks** - Use this section to create, modify, run, and view VI Logger tasks.

The example (Figure 11.1) shows a GPIB interface in MAX after clicking the Scan For Instruments button on the toolbar.

²<http://ni.com/support/gpib/versions.htm>

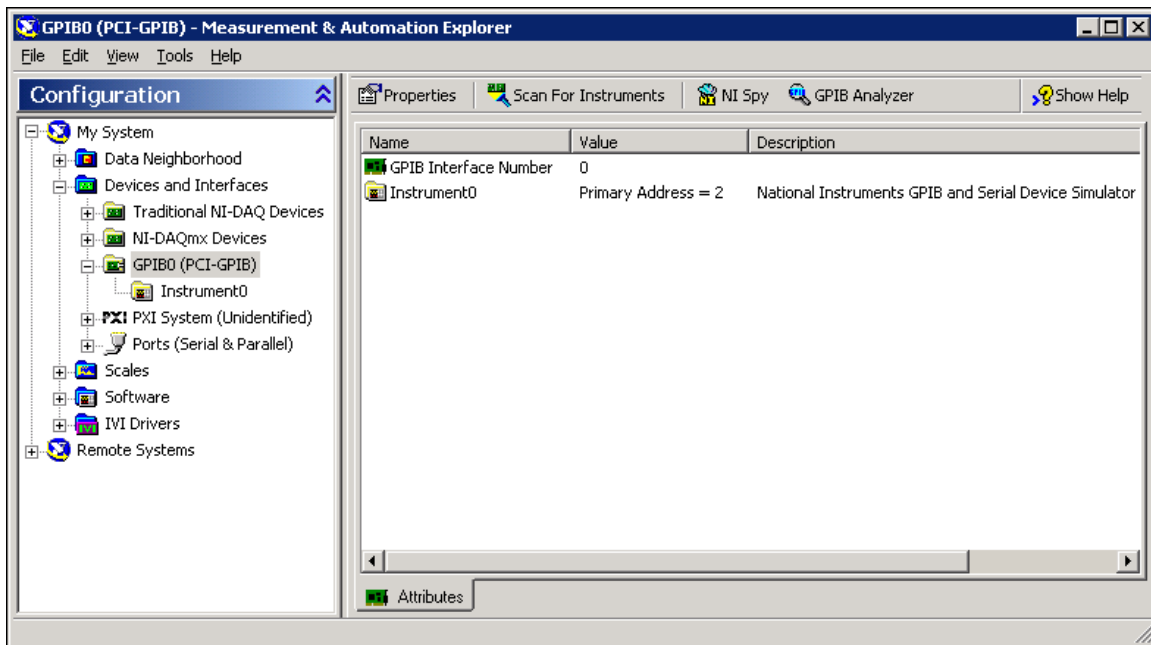

Figure 11.1

The Remote Systems section in the Configuration pane allows you to view and configure remote systems, such as RT Series PXI Controllers. Configure the objects listed in MAX by right-clicking each item and selecting an option from the shortcut menu.

11.3 GPIB Configuration with MAX (Windows Only)

1. Power off the NI Instrument Simulator and configure it to communicate through GPIB by setting the following left bank of switches (Figure 11.2) on the side of the box.

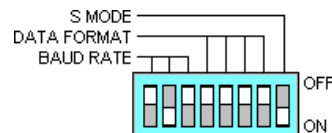

Figure 11.2

2. Power on the NI Instrument Simulator and verify that both the Power and Ready LEDs are lit.
3. Launch MAX by either double-clicking the icon on the desktop or by selecting Tools»Measurement & Automation Explorer in LabVIEW.

4. Expand the Devices and Interfaces section to display the installed interfaces. If a GPIB interface is listed, the NI-488.2 software is correctly loaded on the computer.
5. Select the GPIB interface and click the Properties button on the toolbar to display the Properties dialog box.
6. Examine but do not change the settings for the GPIB interface, and click the OK button.
7. Make sure the GPIB interface is still selected in the Devices and Interfaces section and click the Scan for Instruments button on the toolbar.
8. Expand the GPIB board section. One instrument named Instrument0 appears.
9. Click Instrument0 to display information about it in the right pane of MAX. The NI Instrument Simulator has a GPIB **primary address (PAD)** of 2.
10. Click the Communicate with Instrument button on the toolbar. An interactive window appears. You can use it to query, write to, and read from that instrument.
11. Type *IDN? in Send String and click the Query button. The instrument returns its make and model number in String Received. You can use this window (Figure 11.3) to debug instrument problems or to verify that specific commands work as described in the instrument documentation.

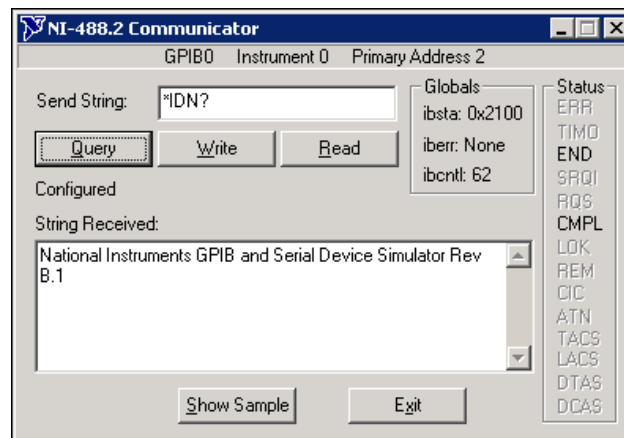

Figure 11.3

12. Type MEAS:DC? in Send String and click the Query button. The NI Instrument Simulator returns a simulated voltage measurement.
13. Click the Query button again to return a different value.
14. Click the Exit button.
15. Set a VISA alias for the NI Instrument Simulator so you can use the alias instead of having to remember the primary address.
 - (a) While Instrument0 is selected in MAX, click the VISA Properties button to display the Properties dialog box.

- (b) Type `devsim` in the VISA Alias field and click the OK button. You will use this alias throughout this lesson.
16. Select `File»Exit` to exit MAX.

11.4 Using the Instrument I/O Assistant

The Instrument I/O Assistant located on the `Functions»Input` and `Functions»All Functions»Instrument I/O` palettes is a LabVIEW Express VI which you can use to communicate with message-based instruments and graphically parse the response. For example, you can communicate with an instrument that uses a serial, Ethernet, or GPIB interface. Use the Instrument I/O Assistant when an instrument driver is not available.

The Instrument I/O Assistant organizes instrument communication into ordered steps. To use Instrument I/O Assistant, you place steps into a sequence. As you add steps to the sequence, they appear in the Step Sequence window. Use the view associated with a step to configure instrument I/O.

To launch the Instrument I/O Assistant, place the Instrument I/O Assistant Express VI on the block diagram. The Instrument I/O Assistant configuration dialog box appears. If it does not appear, double-click the Instrument I/O Assistant icon. Complete the following steps (pg 218) to configure the Instrument I/O Assistant.

1. Select an instrument. Instruments that have been configured in MAX appear in the Select an instrument pull-down menu.
2. Choose a Code generation type. VISA code generation allows for more flexibility and modularity than GPIB code generation.
3. Select from the following communication steps using the Add Step button:
 - **Query and Parse** - Sends a query to the instrument, such as `*IDN?` and parses the returned string. This step combines the Write command and Read and Parse command.
 - **Write** - Sends a command to the instrument.
 - **Read and Parse** - Reads and parses data from the instrument.
4. After adding the desired number of steps, click the Run button to test the sequence of communication that you have configured for the Express VI.
5. Click the OK button to exit the Instrument I/O Assistant configuration dialog box.

LabVIEW adds input and output terminals to the Instrument I/O Assistant Express VI on the block diagram that correspond to the data you will receive from the instrument.

To view the code generated by the Instrument I/O Assistant, right-click the Instrument I/O Assistant icon and select `Open Front Panel` from the shortcut menu. This converts the Express VI to a subVI. Switch to the block diagram to see the code generated.

NOTE: Once an Express VI has been converted to a subVI, it cannot be converted back.

11.5 Using the Instrument I/O Assistant Exercise

Exercise 11.1:

11.5.1 Front Panel

1. Open a blank VI.
2. The front panel in Figure 11.4 will result from building the block diagram.

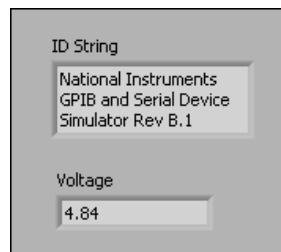

Figure 11.4

11.5.2 Block Diagram

1. Display and build the block diagram shown in Figure 11.5.

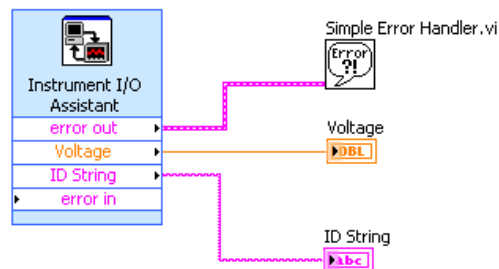



Figure 11.5

- (a)  Place the Instrument I/O Assistant Express VI, located on the Functions>>Input palette, on the block diagram. Complete the following steps to configure the Express VI in the Instrument I/O Assistant dialog box.
- i. Select devsim from the Select an instrument pull-down menu and select VISA Code Generation from the Code generation type pull-down menu.
 - ii. Click the Add Step button. Click Query and Parse to write and read from the Instrument Simulator.
 - iii. Type *IDN? as the command, select \n as the Termination character, and click the Run this step button. If no error warning appears in the lower half of the dialog box, this step has successfully completed.

- iv. To parse the data received, click the Auto parse button. Notice that Token now appears in the Outputs pane on the left side of the dialog box. This value represents the string returned from the identification query. Rename Token by typing ID String in the Token name text box.
 - v. Click the Add Step button. Click Query and Parse. Type MEAS:DC? as the command and click the Run this step button.
 - vi. To parse the data received, click the Auto parse button. The data returned is a random numeric value. Rename Token by typing Voltage in the Token name text box.
 - vii. Click the OK button to exit the I/O Assistant and return to the block diagram.
- (b) Right-click the ID String output and select Create»Indicator from the shortcut menu.
 - (c) Right-click the Voltage output and select Create»Indicator from the shortcut menu.
 - (d) Wire the Error Out output to the Simple Error Handler VI.
2. Display the front panel and run the VI. Resize the string indicator if necessary.
 3. Save the VI as Read Instrument Data.vi in the C:\Exercises\LabVIEW Basics I directory.
 4. Right-click the I/O Assistant and select Open Front Panel. Click the Convert button when asked if you want to convert to a subVI.
 5. View the code generated by the I/O Assistant. Where is the command *IDN? written to the Instrument Simulator? Where is the voltage being read?
 6. Select File»Exit to exit the subVI. Do not save changes.

11.6 VISA

11.6.1 Overview

In 1993, National Instruments joined with GenRad, Racal Instruments, Tektronix, and Wavetek to form the VXIplug&play Systems Alliance. The goals of the alliance are to ensure multivendor interoperability for VXI systems and to reduce the development time for an operational system.

A key part of these goals was to develop a new standard for instrument drivers, soft front panels, and I/O interface software. The term VXIplug&play has come to indicate the conformity of hardware and software to these standards.

In directing their efforts toward software standardization, VXIplug&play members identified the following set of guiding principles:

- Maximize ease of use and performance
- Maintain long-term compatibility with the installed base
- Maintain multivendor open architectures
- Maximize multiplatform capability
- Maximize expandability and modularity in frameworks
- Maximize software reuse
- Standardize the use of system software elements

- Treat instrument drivers as part of the instrument
- Accommodate established standards
- Maximize cooperative support of users

VISA is the VXIplug&play I/O software language that is the basis for the software standardization efforts of the VXIplug&play Systems Alliance. VISA by itself does not provide instrumentation programming capability. It is a high-level API that calls in low-level drivers. VISA can control VXI, GPIB, serial, or computer-based instruments and makes the appropriate driver calls depending on the type of instrument used. When debugging VISA problems, remember this hierarchy. An apparent VISA problem could be an installation problem with one of the drivers that VISA calls.

In LabVIEW, VISA is a single library of functions you use to communicate with GPIB, serial, VXI, and computer-based instruments. You do not need to use separate I/O palettes to program an instrument. For example, some instruments give you a choice for the type of interface. If the LabVIEW instrument driver were written with functions on the Functions»All Functions»Instrument I/O»GPIB palette, those instrument driver VIs would not work for the instrument with the serial port interface. VISA solves this problem by providing a single set of functions that work for any type of interface. Therefore, all LabVIEW instrument drivers use VISA as the I/O language.

11.6.2 VISA Programming Terminology

The functions you can use with a resource are operations. The resource also has variables, or attributes, that contain information related to the resource. The following terminology is similar to that used for instrument driver VIs:

- **Resource** - Any instrument in the system, including serial and parallel ports.
- **Session** - You must open a VISA session to a resource to communicate with it, similar to a communication channel. When you open a session to a resource, LabVIEW returns a VISA session number, which is a unique refnum to that instrument. You must use the session number in all subsequent VISA functions.
- **Instrument Descriptor** - Exact name of a resource. The descriptor specifies the interface type (GPIB, VXI, ASRL), the address of the device (logical address or primary address), and the VISA session type (INSTR or Event).

The instrument descriptor is similar to a telephone number, the resource is similar to the person with whom you want to speak, and the session is similar to the telephone line. Each call uses its own line, and crossing these lines results in an error. The table (pg 221) shows the proper syntax for the instrument descriptor.

Interface	Syntax
Asynchronous serial	ASRL[board][::INSTR]
GPIB	GPIB[board]::primary address::secondary address[::INSTR]
VXI instrument through embedded or MXIbus controller	VXI[board]::VXI logical address[::INSTR]
GPIB-VXI controller	GPIB-VXI[board]::GPIB-VXI primary address::VXI logical address[::INSTR]

You can use an alias you assign in MAX instead of the instrument descriptor. (*Mac OS*) Edit the visaconf.ini file to assign a VISA alias. (*UNIX*) Use the visaconf utility.

If you choose not to use the Instrument I/O Assistant to automatically generate code for you, you can still write a VI to communicate with the instrument. The most commonly used VISA communication functions are the VISA Write and VISA Read functions. Most instruments require you to send information in the form of a command or query before you can read information back from the instrument. Therefore, the VISA Write function is usually followed by a VISA Read function.

11.7 Programming with VISA

1. Make sure the Instrument Simulator is powered on and connected to the GPIB Interface.

11.7.1 Front Panel

1. Open a blank VI. The front panel shown in Figure 11.6 will result from building the block diagram.

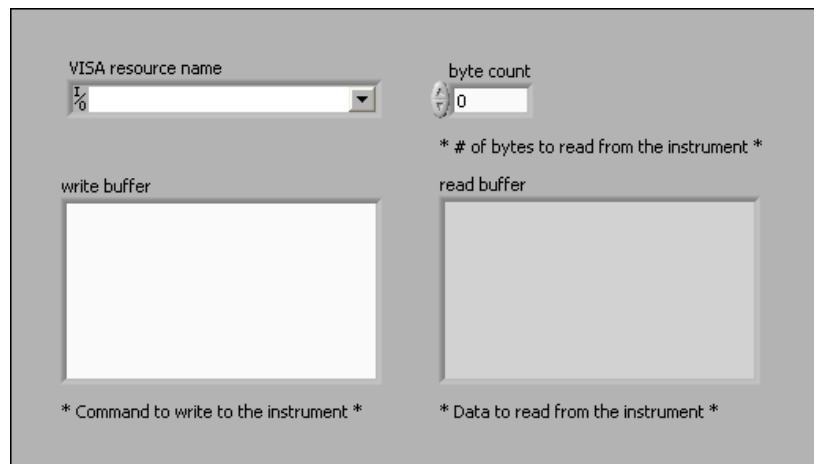

Figure 11.6

11.7.2 Block Diagram

1. Build the block diagram shown in Figure 11.7.

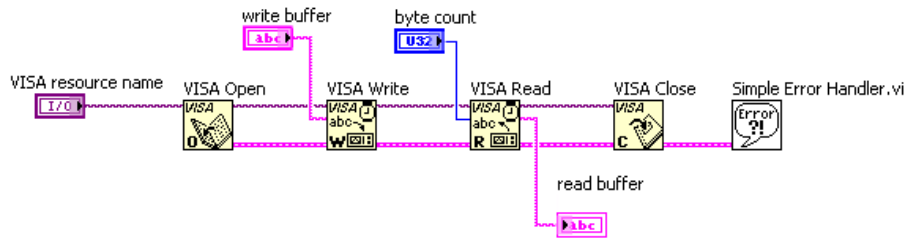







Figure 11.7

- (a)  Place the VISA Open function, located on the Functions>>All Functions>>Instrument I/O>>VISA>>VISA Advanced palette, on the block diagram. This function opens a VISA session with an instrument. Right-click the VISA resource name input and select Create>>Control from the shortcut menu.
 - (b)  Place the VISA Write function, located on the Functions>>All Functions>>Instrument I/O>>VISA palette, on the block diagram. This function writes a string to the instrument. Right-click the write buffer input and select Create>>Control from the shortcut menu.
 - (c)  Place the VISA Read function, located on the Functions>>All Functions>>Instrument I/O>>VISA palette, on the block diagram. This function reads data from the instrument. Right-click the byte count input and select Create>>Control from the shortcut menu. Right-click the read buffer output and select Create>>Indicator from the shortcut menu.
 - (d)  Place the VISA Close function, located on the Functions>>All Functions>>Instrument I/O>>VISA>>VISA Advanced palette, on the block diagram. This function closes the session with the instrument and releases any system resources that were used.
 - (e)  Place the Simple Error Handler VI, located on the Functions>>All Functions>>Time & Dialog palette, on the block diagram. This VI checks error conditions and opens a dialog box with error information if an error occurs.
2. Save the VI as My VISA Write & Read.vi in the C:\Exercises\LabVIEW Basics I directory.
 3. Display the front panel. Enter devsim in the VISA resource name input and set byte count to 200 to make sure you read all the information. Type *IDN? in the write buffer and run the VI.
 4. The top of the instrument simulator lists other commands that are recognized by this instrument. Try other commands in this VI.
 5. Close the VI when finished.

11.8 About Instrument Drivers

An instrument driver is a set of modular software functions that use the instrument commands or protocol to perform common operations with the instrument. The instrument driver also calls the appropriate VIs and functions for the instrument. LabVIEW instrument drivers eliminate the need to learn the complex, low-level programming commands for each instrument.

The LabVIEW instrument driver library contains instrument drivers for a variety of programmable instruments that use the GPIB, VXI, PXI, or serial interfaces.

Instrument drivers receive, parse, and scale the response strings from instruments into scaled data that you can use in test applications. Instrument drivers help make test applications easier to maintain because the drivers contain all the I/O for an instrument in one library, separate from other code. When you upgrade hardware, it is easier to upgrade the application because all the code specific to that instrument is contained in the instrument driver.

The LabVIEW instrument driver library is located on the LabVIEW CD. You also can download drivers from the National Instruments Web site at ni.com/idnet³. To install the LabVIEW instrument drivers, decompress the instrument driver file to get a directory of instrument driver files. Place this directory in the `\labview\instr.lib`. The next time you open LabVIEW, you can access the instrument driver VIs on the Functions»All Functions»Instrument I/O»Instrument Drivers palette.

11.8.1 Getting Started Example

All instrument drivers include an example that can be used to test communication with the instrument. This example is usually called the Getting Started Example. Specify the correct GPIB address (or VISA Resource Name) for the instrument as configured in MAX.

11.9 Using Instrument Driver VIs

Instrument drivers are developed with a specific instrument in mind and eliminate the need for the user to know the exact IEEE 488.2 commands that the instrument is expecting.

11.9.1 Components of an Instrument Driver

All instrument drivers in the library have the same basic VI hierarchy. The hierarchy, sequence of VIs, and error handling are the same as those used in other areas of I/O in LabVIEW, such as file I/O, DAQ, TCP/IP, and so on. Refer to the File I/O VIs and Functions (Section 9.4) section of the Strings and File I/O lesson, for more information about error handling.

Figure 11.8 shows the hierarchy of an instrument driver.

³<http://www.ni.com/devzone/idnet/>

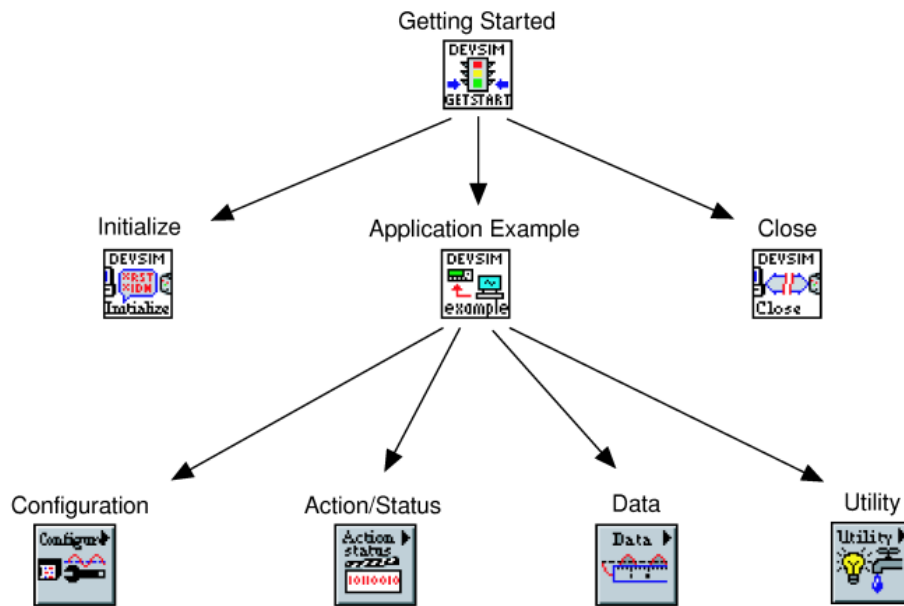

Figure 11.8

The high-level functions are built from the low-level functions. For the most control over the instrument, use the low-level functions. The high-level functions are easy to use and have soft front panels that resemble the instrument. Instrument drivers have VIs in the following categories:

- **Initialize** - Initializes the communication channel to the instrument. This VI also can perform an identification query and reset operation, and it can perform any necessary actions to place the instrument in its default power-on state or other specified state.
- **Configuration** - Configures the instrument to perform operations, such as setting up the trigger rate.
- **Action/Status** - Contains two types of VIs. Action VIs cause the instrument to initiate or terminate test and measurement operations. Status VIs obtain the current status of the instrument or the status of pending operations. An example of an action VI is Acquire Single Shot. An example of a status VI is Query Transfer Pending.
- **Data** - Transfers data to or from the instrument, such as reading a measured waveform from the instrument or downloading a waveform to the instrument.
- **Utility** - Performs a wide variety of functions, such as reset, self-test, error query, and revision query.
- **Close** - Terminates the communication channel to the instrument and deallocates the resources for that instrument.

All National Instruments instrument drivers are required to implement the following functions: initialize, close, reset, self-test, revision query, error query, and error message.

11.9.1.1 Application Examples

LabVIEW also includes application example VIs that show how to use the component VIs to perform common tasks. Typically, this includes configuring, triggering, and returning measurements from an instrument. An application example VI does not initialize or close the instrument driver. These VIs are not intended to be a soft front panel for the instrument but rather to demonstrate some instrument driver capabilities and guide you in developing your own VI.

11.9.2 Inputs and Outputs of Instrument Driver VIs

Just as all instrument drivers share a common VI hierarchy, they also share common inputs and outputs.

11.9.2.1 Resource Name or Instrument Descriptor

When you initialize the communication channel to an instrument, you must know the resource name or instrument descriptor. A resource is an instrument or interface, and the instrument descriptor is the exact name and location of a resource in the following format:

```
Interface Type[board index]::Address::INSTR
```

Optional parameters are shown in square brackets []. For example, GPIB::2::INSTR is the instrument descriptor for a GPIB instrument at address 2.

The VISA resource name control located on the Controls»All Controls»I/O palette is similar to the DAQ channel name control, but it is specifically used for instrument control. Refer to the VISA (Section 11.6) section for more information about VISA.

You can use MAX to determine what resources and instrument addresses are available, as you did in GPIB Configuration with MAX (Section 11.3) when you assigned a VISA alias of devsim to the NI Instrument Simulator. The alias makes it easier to communicate with instruments because you no longer need to memorize which interface and address each instrument uses. You can use the alias in the VISA resource name control instead of the instrument descriptor. For example, you can type devsim instead of GPIB::2::INSTR.

11.9.2.2 VISA Sessions

After you initialize an instrument, the Initialize VI returns a VISA session number. The VISA session is a connection or link to a resource, such as the instrument. You do not need to display this value. However, each time you communicate with that device, you must wire the VISA session input on the instrument driver VIs. After you finish communicating with the instrument, you use the Close VI to close all references or resources for the instrument.

Example 11.1: Example Instrument Driver Application

The block diagram in Figure 11.9 initializes the instrument with the devsim alias, uses a configuration VI to select a waveform, uses two data VIs to read the waveform and the waveform scaling information, closes the instrument, and checks the error status. Every application that uses an instrument driver has a similar sequence of events.

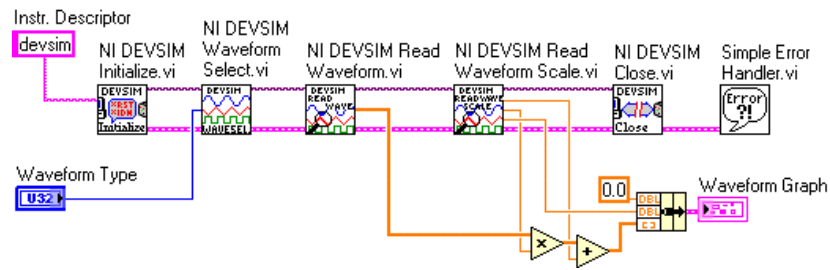

Figure 11.9

11.10 Voltage Monitor VI

11.10.1 Front Panel

1. Select File»New, then select Template»Frameworks»Single Loop Application to open the Single Loop Application template VI.
2. Build the front panel shown in Figure 11.10.

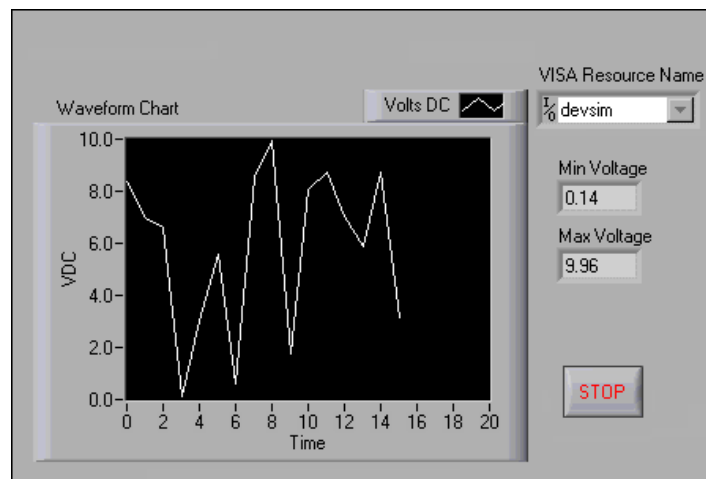

Figure 11.10

Use the following guidelines to help you construct the front panel.

- Place a VISA resource name control, located on the Controls»All Controls»I/O palette, on the front panel.
- Set the x-axis scale of the waveform chart to show incremental values.

11.10.2 Block Diagram

1. Build the block diagram shown in Figure 11.11.

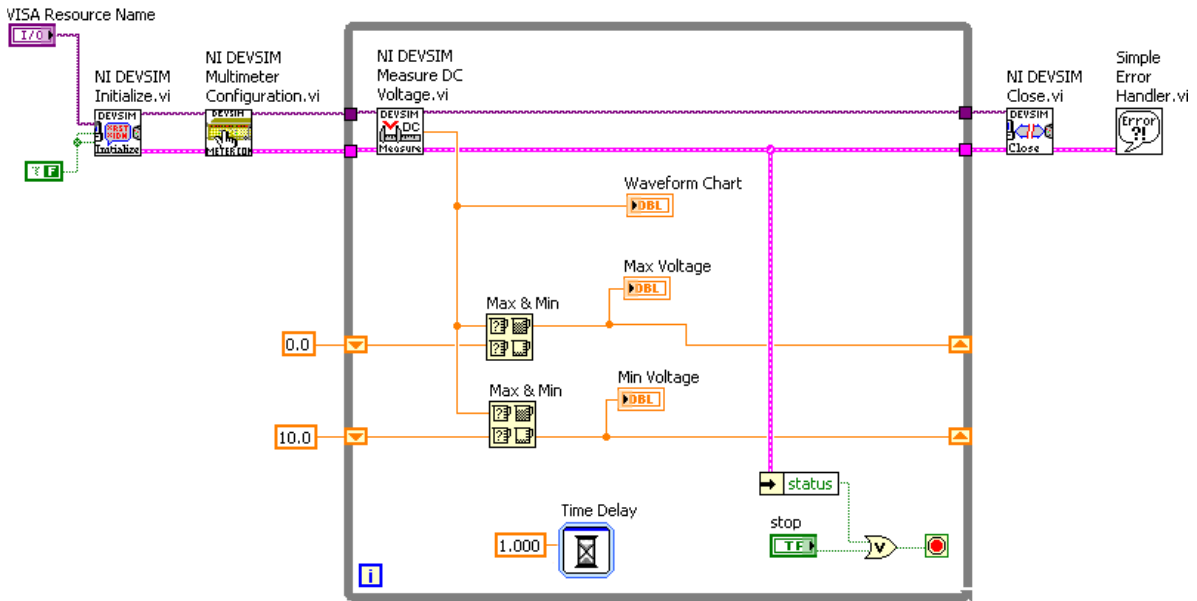











Figure 11.11

- (a) Create two shift registers by right-clicking the right or left border of the loop and selecting Add Shift Register from the shortcut menu.

- (b)  Place the NI DEVSIM Initialize VI, located on the Functions>>Input>>Instrument Drivers>>NI Device Simulator palette, on the block diagram. This VI opens communication between LabVIEW and the NI Instrument Simulator.
 - Right-click the ID Query input and select Create>>Constant from the shortcut menu. Use the Operating tool to change the constant to a False value.
 - Wire the Boolean constant to the Reset input.

- (c)  Place the NI DEVSIM Multimeter Configuration VI, located on the Functions>>Input>>Instrument Drivers>>NI Device Simulator>>Configuration palette, on the block diagram. This VI configures the range of voltage measurements that the NI Instrument Simulator generates. The default is 0.0 to 10.0 V DC.

- (d)  Place the NI DEVSIM Measure DC Voltage VI, located on the Functions>>Input>>Instrument Drivers>>NI Device Simulator>>Data palette, on the block diagram. This VI returns a simulated voltage measurement from the NI Instrument Simulator.

- (e)  Place the NI DEVSIM Close VI, located on the Functions»Input»Instrument Drivers»NI Device Simulator palette, on the block diagram. This VI ends communication between LabVIEW and the NI Instrument Simulator.
- (f)  Place the Max & Min function, located on the Functions»All Functions»Comparison palette, on the block diagram. Use two of these functions to check the current voltage against the minimum and maximum values stored in the shift registers.
- (g)  Place the Simple Error Handler VI, located on the Functions»All Functions»Time & Dialog palette, on the block diagram. This VI displays a dialog box if an error occurs and displays the error information.
- (h)  Place the Unbundle by Name function, located on the Functions»All Functions»Cluster palette, on the block diagram. This function accepts status from the error cluster.
- (i)  Place the Or function, located on the Functions»Arithmetic & Comparison»Express Boolean palette, on the block diagram. This function controls when the While Loop ends. If there is an error or you click the Stop button, the While Loop stops.
- (j)  Set the wait for the Time Delay Express VI to 1 second.
- (k) Wire the block diagram as shown in Figure 11.11.

NOTE: You do not need to wire every terminal for each node. Wire only the necessary inputs for each node, such as instrument descriptor, VISA session, and error I/O.

2. Save the VI as Voltage Monitor.vi in the C:\Exercises\LabVIEW Basics I directory.
3. Make sure the NI Instrument Simulator is powered on.
4. Display the front panel and run the VI. The LEDs alternate between Listen and Talk as LabVIEW communicates with the GPIB instrument once a second to get a simulated voltage reading. This voltage displays on the chart, and the minimum and maximum values update accordingly.
5. Stop and close the VI.

11.11 Serial Port Communication

Serial communication (Figure 11.12) is a popular means of transmitting data between a computer and a peripheral device such as a programmable instrument or even another computer. Serial communication uses a transmitter to send data, one bit at a time, over a single communication line to a receiver. You can use this method when data transfer rates are low or you must transfer data over long distances. Serial communication is popular because most computers have one or more serial ports, so no extra hardware is needed other than a cable to connect the instrument to the computer or two computers together.

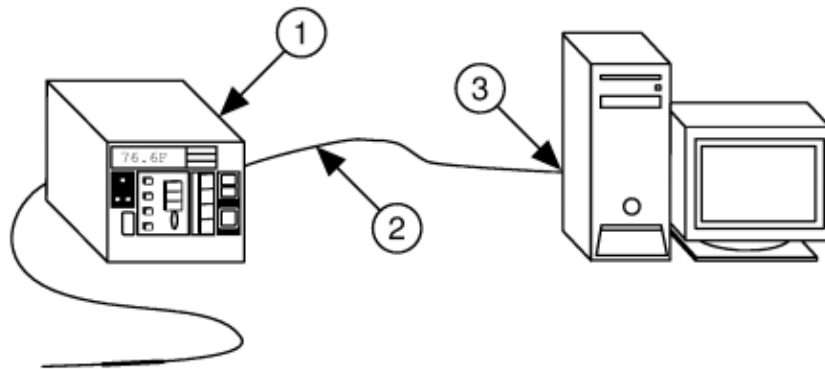

Figure 11.12: 1: RS-232 Instrument, 2: RS-232 Cable, 3: Serial Port

Serial communication requires that you specify the following four parameters:

- The baud rate of the transmission
- The number of data bits encoding a character
- The sense of the optional parity bit
- The number of stop bits

Each transmitted character is packaged in a character frame that consists of a single start bit followed by the data bits, the optional parity bit, and the stop bit or bits. Figure 11.13 shows a typical character frame encoding the letter *m*.

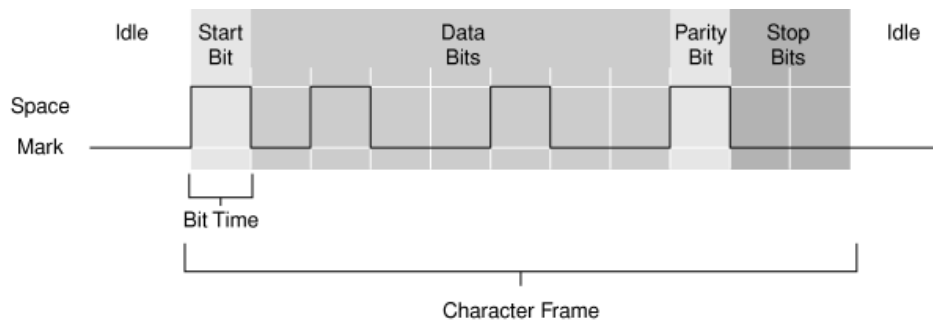

Figure 11.13

Baud rate is a measure of how fast data are moving between instruments that use serial communication. RS-232 uses only two voltage states, called MARK and SPACE. In such a two-state

coding scheme, the baud rate is identical to the maximum number of bits of information, including control bits, that are transmitted per second.

MARK is a negative voltage, and SPACE is positive. Figure 11.13 shows how the idealized signal looks on an oscilloscope. The following is the truth table for RS-232:

$$\text{Signal} > 3V = 0$$

$$\text{Signal} > -3V = 1$$

The output signal level usually swings between +12 V and -12 V. The dead area between +3 V and -3 V is designed to absorb line noise.

A start bit signals the beginning of each character frame. It is a transition from negative (MARK) to positive (SPACE) voltage. Its duration in seconds is the reciprocal of the baud rate. If the instrument is transmitting at 9,600 baud, the duration of the start bit and each subsequent bit is about 0.104 ms. The entire character frame of eleven bits would be transmitted in about 1.146 ms.

Data bits are transmitted upside down and backwards. That is, inverted logic is used, and the order of transmission is from least significant bit (LSB) to most significant bit (MSB). To interpret the data bits in a character frame, you must read from right to left and read 1 for negative voltage and 0 for positive voltage. This yields 1101101 (binary) or 6D (hex). An ASCII conversion table shows that this is the letter m.

An optional parity bit follows the data bits in the character frame. The parity bit, if present, also follows inverted logic, 1 for negative voltage and 0 for positive voltage. This bit is included as a simple means of error handling. You specify ahead of time whether the parity of the transmission is to be even or odd. If the parity is chosen to be odd, the transmitter then sets the parity bit in such a way as to make an odd number of ones among the data bits and the parity bit. This transmission uses odd parity. There are five ones among the data bits, already an odd number, so the parity bit is set to 0.

The last part of a character frame consists of 1, 1.5, or 2 stop bits. These bits are always represented by a negative voltage. If no further characters are transmitted, the line stays in the negative (MARK) condition. The transmission of the next character frame, if any, is heralded by a start bit of positive (SPACE) voltage.

11.11.1 How Fast Can I Transmit?

Knowing the structure of a character frame and the meaning of baud rate as it applies to serial communication, you can calculate the maximum transmission rate, in characters per second, for a given communication setting. This rate is just the baud rate divided by the bits per frame. In the previous example, there are a total of eleven bits per character frame. If the transmission rate is set at 9,600 baud, you get $\frac{9,600}{11} = 872$ characters per second. Notice that this is the maximum character transmission rate. The hardware on one end or the other of the serial link might not be able to reach these rates, for various reasons.

11.11.2 Hardware Overview

There are many different recommended standards of serial port communication, including the following most common types.

11.11.2.1 RS-232

The **RS-232** is a standard developed by the **Electronic Industries Association (EIA)** and other interested parties, specifying the serial interface between **Data Terminal Equipment (DTE)** and **Data Communications Equipment (DCE)**. The RS-232 standard includes electrical signal characteristics (voltage levels), interface mechanical characteristics (connectors), functional description

of interchange circuits (the function of each electrical signal), and some recipes for common kinds of terminal-to-modem connections. The most frequently encountered revision of this standard is called RS-232C. Parts of this standard have been adopted (with various degrees of fidelity) for use in serial communications between computers and printers, modems, and other equipment. The serial ports on standard IBM-compatible personal computers follow RS-232.

11.11.2.2 RS-449, RS-422, RS-423

The RS-449, RS-422, and RS-423 are additional EIA serial communication standards related to RS-232. RS-449 was issued in 1975 and was supposed to supersede RS-232, but few manufacturers have embraced the newer standard. RS-449 contains two sub-specifications called RS-422 and RS-423. While RS-232 modulates a signal with respect to a common ground, or single-ended transmission, RS-422 modulates two signals against each other, or differential transmission. The RS-232C receiver senses whether the received signal is sufficiently negative with respect to ground to be a logical 1, whereas the RS-422 receiver senses which line is more negative than the other. This makes RS-422 more immune to noise and interference and more versatile over longer distances. The Macintosh serial ports follow RS-422, which can be converted to RS-423 by proper wiring of an external cable. RS-423 can then communicate with most RS-232 devices over distances of 15 m or so.

11.11.2.3 RS-232 Cabling

Devices that use serial cables for their communication are split into two categories. These are DCE and DTE. DCE are devices such as a modem, TA adapter, plotter, and so on, while DTE is a computer or terminal. RS-232 serial ports come in two sizes, the D-Type 25-pin connector and the D-Type 9-pin connector. Both of these connectors are male on the back of the PC. Thus, you require a female connector (Figure 11.14) on the device. pg 232 shows the pin connections for the 9-pin and 25-pin D-Type connectors.

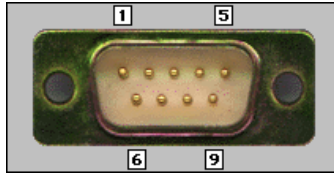

Figure 11.14

Function	Signal	PIN	DTE	DCE
Data	TxD	3	Output	Input
	RxD	2	Input	Output
Handshake	RTS	7	Output	Input
	CTS	8	Input	Output
	DSR	6	Input	Output
	DCD	1	Input	Output
	STR	4	Output	Input
Common	Com	5	–	–
Other	RI	9	Output	Input

The DB-9 connector is occasionally found on smaller RS-232 lab equipment. It is compact, yet has enough pins for the core set of serial pins (with one pin extra).

NOTE: The DB-9 pin numbers for transmit and receive (3 and 2) are opposite of those on the DB-25 connector (2 and 3). Be careful of this difference when you are determining if a device is DTE or DCE.

The DB-25 connector (Figure 11.15) is the standard RS-232 connector, with enough pins to cover all the signals specified in the standard. pg 233 shows only the core set of pins that are used for most RS-232 interfaces.

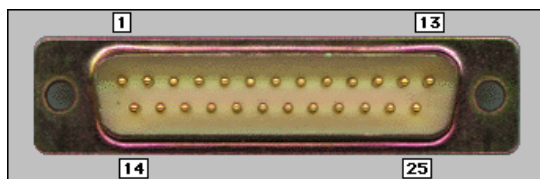

Figure 11.15

Function	Signal	PIN	DTE	DCE
Data	TxD	2	Output	Input
	RxD	3	Input	Output
Handshake	RTS	4	Output	Input
	CTS	5	Input	Output
	DSR	6	Input	Output
	DCD	8	Input	Output
	STR	20	Output	Input
Common	Com	7	–	–

11.11.3 Software Overview

Use the VIs and functions located on the Functions»All Functions»Instrument I/O»Serial palette for serial port communication.

You used some of the VISA functions on this palette for GPIB communication. The VISA Write and VISA Read functions work with any type of instrument communication and are the same whether you are doing GPIB or serial communication. However, because serial communication requires you to configure extra parameters, you must start the serial port communication with the VISA Configure Serial Port VI.

The VISA Configure Serial Port VI initializes the port identified by VISA resource name to the specified settings. timeout sets the timeout value for the serial communication. baud rate, data bits, parity, and flow control specify those specific serial port parameters. The error in and error out clusters maintain the error conditions for this VI.

Example 11.2:

Figure 11.16 shows how to send the identification query command `*IDN?` to the instrument connected to the COM2 serial port. The VISA Configure Serial Port VI opens communication with COM2 and sets it to 9,600 baud, eight data bits, odd parity, one stop bit, and XON/XOFF software handshaking. Then the VISA Write function sends the command. The VISA Read function reads back up to 200 bytes into the read buffer, and the Simple Error Handler VI checks the error condition.

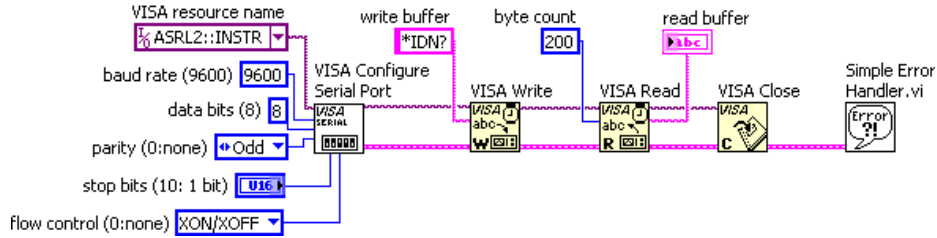

Figure 11.16

NOTE: The VIs and functions located on the Functions » All Functions » Instrument I/O » Serial palette are also used for parallel port communication. You specify the VISA resource name as being one of the LPT ports. For example, you can use MAX to determine that LPT1 has a VISA resource name of ASRL10::INSTR.

11.12 Serial Write & Read VI

11.12.1 NI Instrument Simulator

1. Power off the NI Instrument Simulator and configure it to communicate through the serial port by setting the following switches on the side of the box.

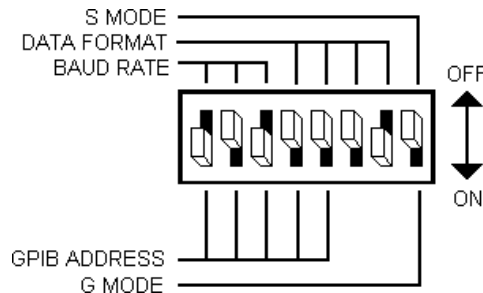

Figure 11.17

These switch settings configure the instrument as a serial device with the following settings:

- Baud rate = 9,600
- Data bits = 8

- Parity = no parity
- Stop bits = 1
- Flow control parameters = hardware handshaking

Handshaking is a means of data flow control. Software handshaking involves embedding control characters in transmitted data. For example, XON/XOFF flow control works by enclosing a transmitted message between the two control characters XON and XOFF. Hardware handshaking uses voltages on physical wires to control data flow. The RTS and CTS lines of the RS-232 device are frequently used for this purpose. Most lab equipment uses hardware handshaking.

2. Make sure the NI Instrument Simulator is connected to a serial port on the computer with a serial cable. Make a note of the port number.
3. Power on the NI Instrument Simulator. The Power, Ready, and Listen LEDs are lit to indicate that the device is in serial communication mode.

11.12.2 Block Diagram

1. Open a blank VI and build the block diagram shown in Figure 11.18.

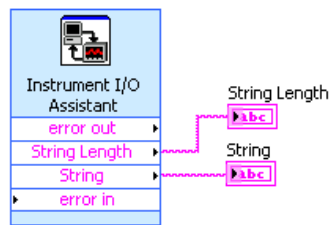



Figure 11.18

- (a)  Place the Instrument I/O Express VI, located on the Functions>>Input palette, on the block diagram. Complete the following steps in the Instrument I/O Assistant dialog box that appears to configure the Express VI.
 - i. Choose COM1 (or COM2 depending on the connection port of the NI Instrument Simulator) from the Select an instrument pull-down menu.
 - ii. Click the Add Step button and click Write. In the command field, type `*IDN?` and select `\n` as the Termination character.
 - iii. Click the Add Step button and click Read and Parse.
 - iv. Click the Add Step button and click Read and Parse again.

NOTE: The Instrument Simulator returns the byte size of the response, the termination character, the response, then another termination character. Therefore, after `*IDN?` is sent to the instrument, the response must be read twice.
 - v. Click the Run button (not the Run this step button). The Run button runs the entire sequence.

- vi. Return to the first Read and Parse step.
- vii. Click the Auto parse button. The value returned is the size in bytes of the query response.
- viii. Rename Token to String Length in the Token name text box.
- ix. Select the second Read and Parse step.
 - x. Click the Auto parse button. The value returned is the identification string of the NI Instrument Simulator.
 - xi. Rename Token to String in the Token name text box. The configuration window should be similar to the Figure 11.19.

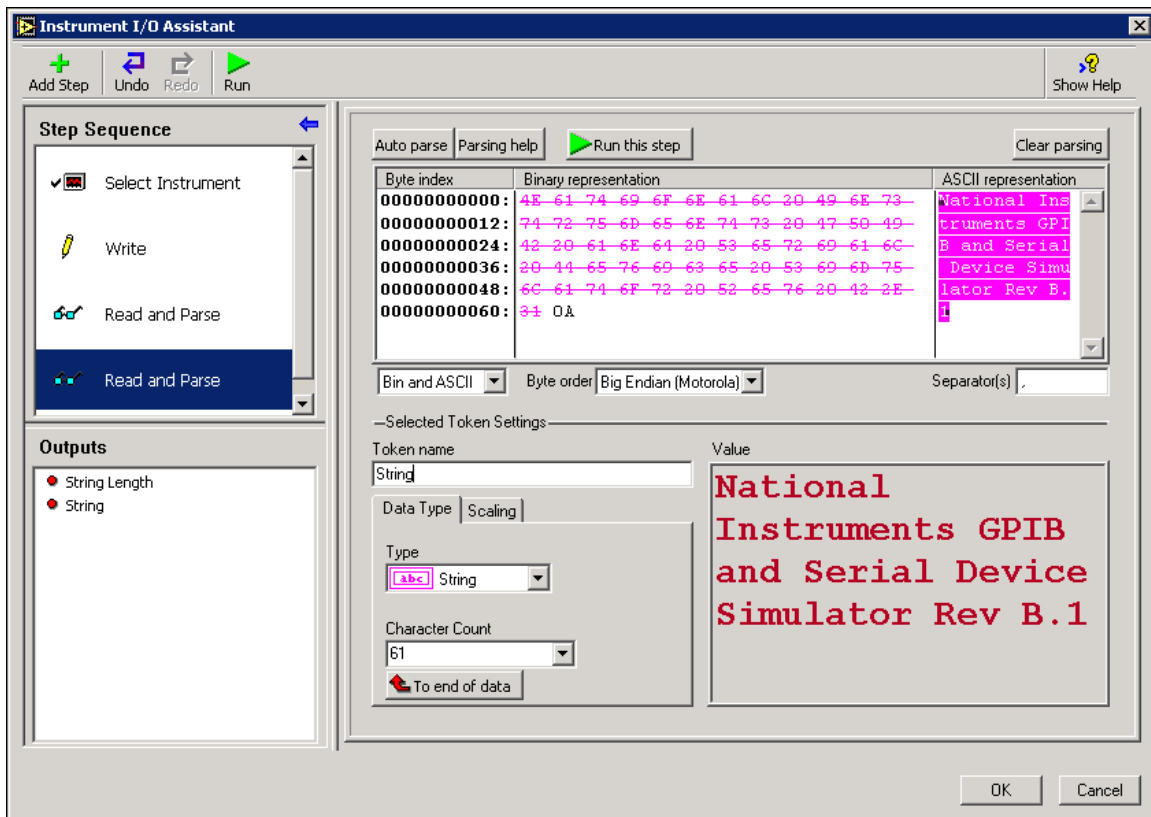

Figure 11.19

- xii. Select OK to return to the block diagram.
- (b) Right-click the String output and select Create>>Indicator from the shortcut menu.
 - (c) Right-click the String Length output and select Create>>Indicator from the shortcut menu.

TIP: Since LabVIEW is set to handle errors automatically, there is no need to connect a Simple Error Handler VI to error out.
2. Display the front panel and run the VI.
 3. Save the VI as Serial Communication.vi in the C:\Exercises\LabVIEW Basics I directory.
 4. Close the VI when finished.

11.13 Waveform Transfers

Many instruments return a waveform as an ASCII string or a binary string. Assuming the same waveform, a binary string transfer is faster and requires less memory than an ASCII string transfer. Binary encoding requires fewer bytes than ASCII encoding.

11.13.1 ASCII Waveforms

As an example, consider a waveform composed of 1,024 points, each point having a value between 0 and 255. Using ASCII encoding, you would need a maximum of 4 bytes to represent each point (a maximum of 3 bytes for the value of the point and 1 byte for the separator, such as a comma). You would need a maximum of 4,096 ($4 \times 1,024$) bytes plus any header and trailer bytes to represent the waveform as an ASCII string. Figure 11.20 is an ASCII waveform string.

<u>CURVE</u>	{12,28,63,...1024 points in total...,}	<u>CR L</u>
Header	Data Point (up to 4 bytes each)	Trailer
(6 bytes)		(2 bytes)

Figure 11.20

You can use the Extract Numbers VI located in the C:\Exercises\LabVIEW Basics I directory to convert an ASCII waveform into a numeric array, as follows. This VI outputs the waveform as a double precision array (Figure 11.21).

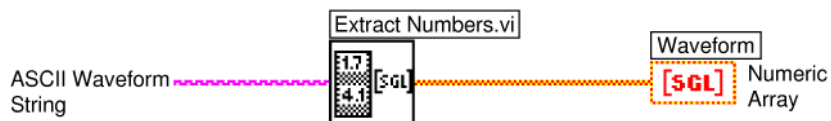

Figure 11.21

11.13.2 Binary Waveforms Encoded as 1-Byte Integers

The same waveform using binary encoding requires only 1,024 bytes ($1 \times 1,024$) plus any header and trailer bytes to be represented as a binary string. Using binary encoding, you need only 1 byte to represent the point, assuming each point is an unsigned 8-bit integer. Figure 11.22 is a binary waveform string.

<u>CURVE %</u>	<u>{MSB}{LSB}</u>	<u>{AAa...1024 bytes in total...}</u>	<u>{Chk} CR</u>
Header	Count	Data Point	Trailer
(7 bytes)	(4 bytes)	(1 byte each)	(3 bytes)

Figure 11.22

Converting the binary string to a numeric array is a little more complex. You must convert the string to an integer array. You can do this by using the String To Byte Array (Figure 11.23) function located on the Functions»All Functions»String»String/Array/Path Conversion palette. You must remove all header and trailer information from the string before you can convert it to an array. Otherwise, this information also is converted.



Figure 11.23

11.13.3 Binary Waveforms Encoded as 2-Byte Integers

If each point in the binary waveform string is encoded as a 2-byte integer, it is easier and much faster to use the Type Cast function located on the Functions»All Functions»Advanced»Data Manipulation palette. Refer to the *LabVIEW Basics II: Development Course Manual* for more information about type casting.

For example, consider a GPIB oscilloscope that transfers waveform data in binary notation. The waveform is composed of 1,024 data points. Each data point is a 2-byte signed integer. Therefore, the entire waveform is composed of 2,048 bytes. In Figure 11.24, the waveform has a 4-byte header DATA and a 2-byte trailer—a carriage return followed by a linefeed.

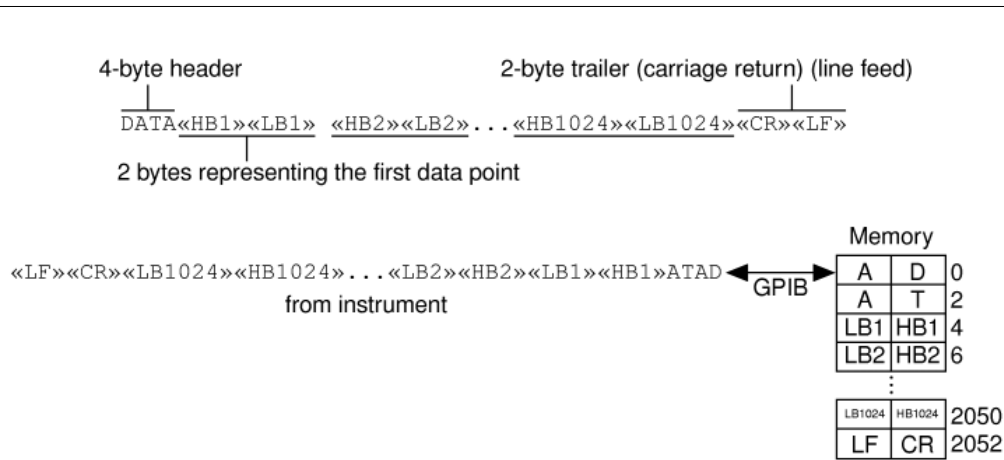

Figure 11.24

The block diagram in Figure 11.25 shows how you can use the Type Cast function to cast the binary waveform string into an array of 16-bit integers.

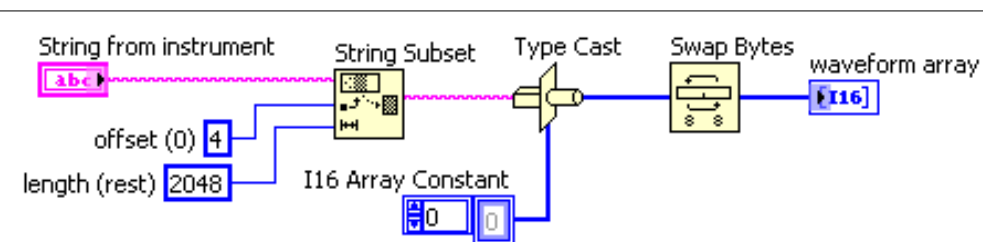

Figure 11.25

You might need to use the Swap Bytes (Figure 11.26) function located on the Functions»All Functions»Advanced»Data Manipulation palette to swap the most significant 8 bits and the least significant 8 bits for every element. Remember, the GPIB is an 8-bit bus. It can transfer only one byte at a time. If the instrument first sends the low byte and then the high byte, you do not need to use the Swap Bytes function.

In the example (Figure 11.25), you needed to use the Swap Bytes (Figure 11.26) function because the instrument sent the most significant byte first. Because the most significant byte is received first, it is placed in a lower memory location than the least significant byte sent after the most significant byte.

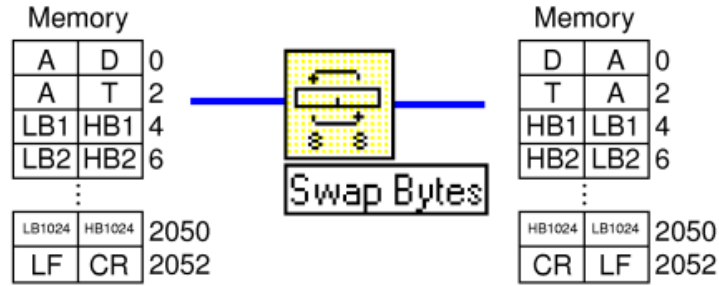

Figure 11.26

11.14 Waveform Example VI

Exercise 11.2:

For the ASCII waveform string, the waveform consists of 128 points. Up to four ASCII characters separated by commas represent each point. The following header precedes the data points:

```
CURVE {12,28,63,...128 points in total...}CR LF
```

For the binary waveform string, the waveform consists of 128 points. Each point is represented as a 1-byte unsigned integer. The following header precedes the data points:

```
CURVE % {Bin Count MSB}{Bin Count LSB}{...128 bytes in total...} {Checksum} CR LF
```

Complete the following steps to examine a VI that converts the waveform to an array of numbers. The VI graphs the array and reads the waveform string from the NI Instrument Simulator or from a previously stored array.

11.14.1 NI Instrument Simulator

1. Power off the NI Instrument Simulator and configure it to communicate through the GPIB by setting the switches (Figure 11.27) on the side of the box.

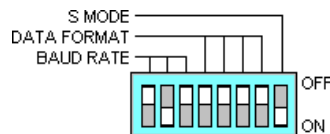

Figure 11.27

These switch settings configure the instrument as a GPIB device with an address of 2.

2. Power on the NI Instrument Simulator. Only the Power and Ready LEDs are lit to indicate that the NI Instrument Simulator is in GPIB communication mode.

11.14.2 Front Panel

1. Open the Waveform Example VI located in the C:\Exercises\LabVIEW Basics I directory. The front panel shown in Figure 11.28 is already built.

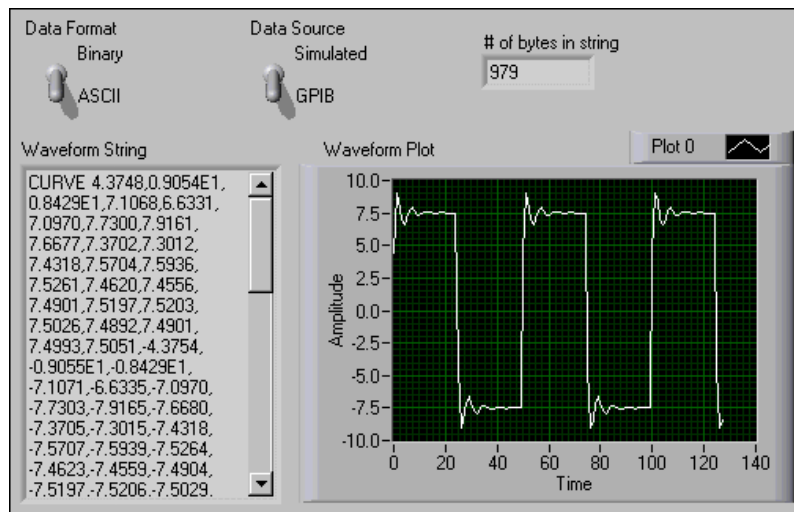

Figure 11.28

Data Format specifies an ASCII waveform or a binary waveform. **Data Source** specifies whether the data is simulated or read from the NI Instrument Simulator through the GPIB.

11.14.3 Block Diagram

1. Display and examine the block diagram shown in Figure 11.29.

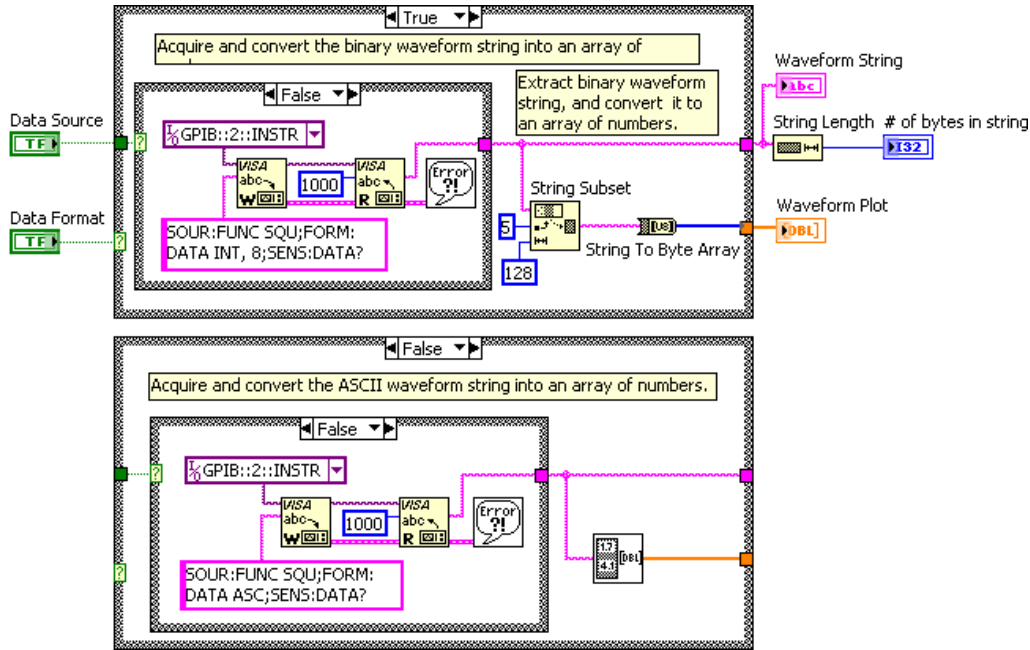







Figure 11.29

-  The String Subset function located on the Functions>>All Functions>>String palette returns a substring of 128 elements starting from the fifth byte of the binary waveform string, excluding the header and trailer bytes.
-  The String to Byte Array function, located on the Functions>>All Functions>>String>>String/Array/Path Conversion palette, converts the binary string to an array of unsigned integers.
-  The String Length function, located on the Functions>>All Functions>>String palette, returns the number of characters in the waveform string.
-  The Extract Numbers VI, located in the Exercises directory, extracts numbers from the ASCII waveform string and places them in an array. Non-numeric characters, such as commas, separate numbers in the string.
- The VISA Write and VISA Read functions, located on the Functions>>All Functions>>Instrument I/O>>VISA palette, query the NI Instrument Simulator for a square wave in either ASCII or 1-byte binary format.
-  The Simple Error Handler VI, located on the Functions>>All Functions>>Time & Dialog palette, reports any errors.

2. Display the front panel and run the VI. The True case acquires and converts the binary waveform string to an array of numeric values. The False case acquires and converts the ASCII waveform string to an array of numeric values.

3. Set Data Format to ASCII and run the VI. The ASCII waveform string displays, the VI converts the values to a numeric array, and displays the string length and numeric array.
4. Set Data Format to Binary and run the VI again. The binary waveform string and string length display, the VI converts the string to a numeric array, and displays it in the graph.

NOTE: The binary waveform is similar to the ASCII waveform. However, the number of bytes in the string is significantly lower. It is more efficient to transfer waveforms as binary strings than as ASCII strings because binary encoding requires fewer bytes to transfer the same information.

5. Close the VI. Do not save changes.

11.15 Summary, Tips, and Tricks on Instrument Control

- LabVIEW can communicate with an instrument that connects to the computer as long as you know what kind of interface it is and what cabling is required.
- Use MAX to configure and test GPIB interface cards, connected instruments, serial ports, and parallel ports.
- LabVIEW instrument drivers eliminate the need to learn the complex, low-level programming commands for each instrument.
- The LabVIEW instrument driver library is located on the LabVIEW CD. You also can download drivers from the NI Web site at ni.com⁴.
- All instrument drivers in the library have the same basic VI hierarchy.
- Use the Instrument I/O Assistant to rapidly and easily build a VI to communicate with an instrument. You can control VXI, GPIB, RS-232, and other types of instruments.
- Serial communication is a popular means of transmitting data between a computer and a peripheral device such as a programmable instrument or even another computer.

11.16 Additional Exercises for Instrument Control

Exercise 11.3:

Open the Voltage Monitor (Section 11.10) VI. Modify the block diagram so that the data are written to a spreadsheet file named `voltage.txt` in the format shown in Figure 11.30.

⁴<http://ni.com>

	A	B	C	D
1	Start Date: 6/8/00	Start Time: 1:26 PM		
2	Max Voltage: 9.151000	Min Voltage: 0.354010		
3	Data:			
4	8.965			
5	9.067			
6	0.354			
7	5.08			
8	4.511			
9	3.946			
10	6.446			
⋮	⋮			
N	2.293			

Figure 11.30

Select File»Save As to save the VI as Voltage Data to File.vi in the C:\Exercises\LabVIEW Basics I directory.

Chapter 12

Customizing VIs

12.1 Configuring the Appearance of Front Panels

After you build a VI, you can configure the appearance of the front panel so users can more easily operate the VI. For example, you can hide the menu bar and scrollbars to create VIs that look and behave like standard dialog boxes for each platform.

Select File»VI Properties to configure the appearance and behavior of a VI. You also can right-click the VI icon on the front panel or block diagram and select VI Properties from the shortcut menu. You cannot access the VI Properties dialog box while a VI is running. Refer to the *LabVIEW Basics II: Development Course Manual* for more information about configuring the behavior of VIs.

Use the Category pull-down menu at the top of the VI Properties dialog box to select from several different option categories, including the following:

- **General** - Displays the current path where a VI is saved, its revision number, revision history, and any changes made since the VI was last saved. You also can use this page to edit the icon or the size of the alignment grid for the VI.
- **Documentation** - Use this page to add a description of the VI and link to a help file topic. Refer to the original Thermometer VI (Section 3.5) for more information about documenting VIs.
- **Security** - Use this page to lock or password-protect a VI.
- **Window Appearance** - Use this page to configure various window settings.
- **Window Size** - Use this page to set the size of the window.
- **Execution** - Use this page to configure how a VI runs. For example, you can configure a VI to run immediately when it opens or to pause when called as a subVI.
- **Editor Options** - Use this page to set the size of the alignment grid for the current VI and to change the style of control or indicator LabVIEW creates when you right-click a terminal and select Create»Control or Create»Indicator from the shortcut menu.

12.1.1 Window Appearance

In the VI Properties dialog box, select Window Appearance from the Category pull-down menu to customize the window appearance for VIs.

These options apply to the VI when it is running. Use these options to change how the user interacts with the application by restricting access to LabVIEW features and by changing the way the window looks and behaves. You can make the VI look and act like a dialog box so the user cannot interact with other windows while the VI window is open. You also can remove the scrollbars and toolbar, and you can set a window to be centered or automatically sized to fit the screen.

By default, the VI window title is the same as the VI name. You can customize the VI window title to make it more descriptive than the VI filename. This is useful for localized VIs so the VI window title can be translated to the local language. Remove the checkmark from the Same as VI Name checkbox to edit Window title.

To configure the window appearance, select one of the following window styles. A graphical representation of each style displays on the right when you select the style.

- **Top-level Application Window** - Shows the title bar and menu bar, hides the scrollbars and toolbar, allows the user to close the window, allows run-time shortcut menus, does not allow resizing, and shows the front panel when called.
- **Dialog** - The VI functions as a dialog box in the operating system, so the user cannot interact with other LabVIEW windows while this VI window is open. This option does not prevent you from bringing windows of other applications to the front. (**UNIX**) You cannot make a window stay in front of all other windows. Dialog style windows stay on top, have no menu bar, scrollbars, or toolbar, allow the user to close the window but not resize it, allow run-time shortcut menus, and show the front panel when called. Also, if a Boolean parameter on the front panel is associated with the <Enter> or <Return> key, LabVIEW highlights the parameter with a dark border.
- **Default** - Same window style used in the LabVIEW development environment.
- **Custom** - Custom window style.
- **Customize** - Displays the Customize Window Appearance dialog box.

12.1.2 Window Size

In the VI Properties dialog box, select Window Size from the Category pull-down menu to customize the window size for VIs. This page includes the following components:

- **Minimum Panel Size** - Sets the minimum size of the front panel. If you allow the user to resize the window on the Window Appearance page, the user cannot resize the front panel smaller than the width and height you set on this page.
- **Size the front panel to the width and height of the entire screen** - Automatically resizes the front panel window to fit the screen when you run the VI. The VI does not retain a record of its original size and location, so it stays in the new location if you switch back to edit mode.
- **Maintain proportions of window for different monitor resolutions** - Resizes the VI so it takes up approximately the same amount of screen space when opened on a computer with a different monitor resolution. For example, if you develop a VI on a computer with a monitor resolution of $1,024 \times 768$, you might want to run the VI on a computer with a monitor resolution of 800×600 . Use this control in conjunction with scaling one or all the objects on the front panel.

- **Scale all objects on front panel as the window resizes** - Automatically resizes all front panel objects with respect to and in proportion to the size of the front panel window. Text does not resize because the font sizes are fixed. Use this option when you allow the user to resize the front panel window.

12.2 Opening SubVI Front Panels when a VI Runs

A single front panel sometimes is too restrictive to present numerous options or displays. To solve this problem, organize VIs so the top-most VI presents high-level options, and subVIs present related options.

TIP: You also can use tab controls to make the front panel more usable.

When LabVIEW calls a subVI, ordinarily the subVI runs without opening its front panel. If you want a single instance of the subVI to open its front panel when called, use the SubVI Node Setup dialog box. If you want every instance of the subVI to open its front panel when called, use the VI Properties dialog box.

12.2.1 Single Instance

If you want a single instance of the subVI to open its front panel when called, right-click the subVI and select SubVI Node Setup from the shortcut menu to display the SubVI Node Setup dialog box. Place checkmarks in the Show Front Panel when called and Close afterwards if originally closed checkboxes to open the subVI front panel when called. This dialog box also includes the following components:

- **Open Front Panel when loaded** - Displays the front panel when the subVI loads or when the VI that calls it loads.
- **Show Front Panel when called** - Displays the front panel when the subVI is called.
- **Close afterwards if originally closed** - If Show Front Panel when called also contains a checkmark and if the subVI was previously closed, the front panel closes after the subVI runs.
- **Suspend when called** - Suspends a subVI when called and waits for user interaction. This option is the same as selecting Operate»Suspend when called.



12.2.2 Every Instance

If you want every instance of the subVI to open its front panel when called, open the subVI and select File»VI Properties. Select Window Appearance from the Category pull-down menu, click the Customize button, and place checkmarks in the Show Front Panel When Called and Close Afterwards if Originally Closed checkboxes.

12.3 Pop-up Graph VI and Use Pop-up Graph VI

Exercise 12.1:

Complete the following steps to build a VI that acquires temperature once every 0.5 seconds for 10 seconds, displays a subVI front panel that shows the acquired data in a graph, and keeps the front panel open until you click a button.

- (b)  Place the Wait Until Next ms Multiple function, located on the Functions»All Functions»Time & Dialog palette, on the block diagram. Right-click the input, select Create»Constant, and type 500 in the constant to cause the For Loop to execute every 500 ms.
- (c)  Place the Multiply function, located on the Functions»Arithmetic & Comparison»Express Numeric palette, on the block diagram. This function multiplies each element of the output array by 0.50 to scale the x values to represent the time interval at which the VI takes the measurements.
- (d)  Place the Pop-up Graph VI, located in the C:\Exercises\LabVIEW Basics I directory, on the block diagram. This VI plots the temperature data on an XY graph.
- (e) Complete the block diagram as shown in the previous figure.
- Save the VI as Use Pop-up Graph.vi in the C:\Exercises\LabVIEW Basics I directory.
 - Configure the subVI to display its front panel when called.
 - Double-click the Pop-up Graph subVI to open its front panel.
 - Select File»VI Properties.
 - Select Window Appearance from the Category pull-down menu.
 - Click the Customize button. Configure the window appearance as shown in the dialog box (Figure 12.3).

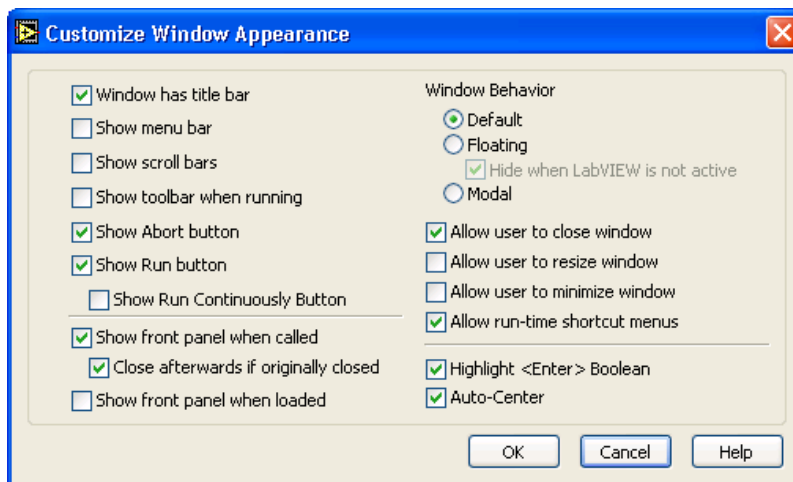

Figure 12.3

- (e) Click the OK button twice and save and close the subVI. If the front panel is not closed, it will not close after the subVI runs.
- Run the Use Pop-up Graph VI. After the VI acquires 10 seconds of temperature data, the front panel of the Pop-up Graph VI displays and plots the temperature data. Click the DONE button to return to the calling VI.
 - Change the window appearance settings for the Pop-up Graph subVI to the Dialog window style.

6. Save and close the subVI.
7. Run the Use Pop-up Graph VI again. The Pop-up Graph subVI front panel window behaves as a dialog box. For example, the window stays on top of all other windows and uses the system colors.
8. Close all open VIs.

12.4 Keyboard Shortcuts for Controls

While a VI runs, you can press the <Tab> key to change the key focus from one control to the next. The key focus is the same as if you had clicked the control. While a control has the key focus, you can use the keyboard to enter the control value. If the control is a text or numeric control, LabVIEW highlights the text so you can edit it. If the control is Boolean, press the spacebar or the <Enter> key to change its value.

You also can assign keyboard shortcuts to controls so users can navigate the front panel by pressing other keys. Right-click the control and select Advanced»Key Navigation from the shortcut menu to display the Key Navigation dialog box.

NOTE: The Advanced»Key Navigation shortcut menu item is dimmed for indicators because you cannot enter data in an indicator.

Select the shortcut key you want to assign to the control in the Key Assignment section. The front panel control names that appear in the Current Assignments listbox correspond to the owned labels of those controls.

To prevent users from accessing a control by pressing the <Tab> key while the VI runs, place a checkmark in the Skip this control when tabbing checkbox.

12.5 Temperature System VI

Exercise 12.2:

12.5.1 Front Panel

1. Open the Temperature System VI located in the C:\Exercises\ LabVIEW Basics I directory. The following front panel is already built.

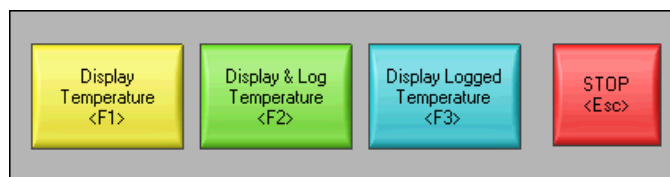

Figure 12.4

The front panel contains four Boolean buttons (Figure 12.4). The mechanical action of the first three buttons is Latch When Pressed. This setting changes the control value when you click it and retains the new value until the VI reads it once. At this point the control reverts to its default value, even if you keep pressing the mouse button. This action is similar to a circuit breaker and is useful for stopping While

Loops or for getting the VI to perform an action only once each time you set the control. The mechanical action of the Stop button is Latch When Released. This setting changes the control value only after you release the mouse button within the graphical boundary of the control. When the VI reads it once, the control reverts to the old value. This action guarantees at least one new value. This action is similar to dialog box buttons and system buttons.

2. Right-click a control and select Advanced » Key Navigation from the shortcut menu to display the Key Navigation dialog box.
3. In the Key Assignment section, assign the shortcut key shown in the Figure 12.4.
4. Repeat pg 251 and pg 251 for each control.

12.5.2 Block Diagram

1. Examine the block diagram (Figure 12.5) which is already built.

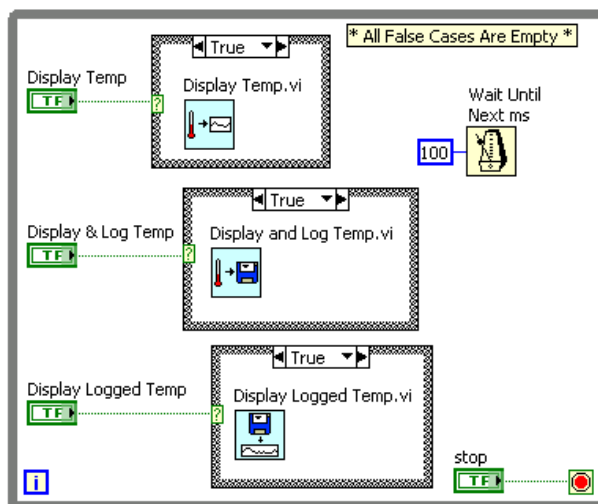





Figure 12.5

-  The Display Temp VI simulates a temperature measurement every 500 ms and plots it on a strip chart.
-  The Display and Log Temp VI simulates a temperature measurement every 500 ms, plots it on a strip chart, and logs it to a file.
-  The Display Logged Temp VI opens a file that you select, reads the logged data, and displays them on a graph.

2. Configure each subVI to display its front panel when called.

- (a) Right-click the subVI and select SubVI Node Setup from the shortcut menu.

- (b) Place checkmarks in the Show Front Panel when called and Close afterwards if originally closed checkboxes.
 - (c) Click OK to close the SubVI Node Setup dialog box.
 - (d) Repeat pg 251 through pg 252 for the remaining two subVIs.
3. Save the VI. Display the front panel and run the VI.
 4. Click each button and press the corresponding keyboard shortcuts. The three subVIs return to the Temperature System VI front panel when you press the <Enter> key. Try pressing the <Enter> key to do so.
 5. Stop the VI.
 6. Configure the Temperature System VI to run automatically when you open the VI.
 - (a) Select File»VI Properties.
 - (b) Select Execution from the Category pull-down menu.
 - (c) Place a checkmark in the Run When Opened checkbox.
 7. Configure the VI so the menu bar and toolbar are not visible while the VI runs.
 - (a) Select Window Appearance from the Category pull-down menu.
 - (b) Click the Customize button.
 - (c) Remove the checkmarks from the Show Menu Bar and Show Toolbar When Running checkboxes.
 - (d) Click the OK button twice.
 8. Save and close all VIs.
 9. Open the Temperature System VI again. The VI runs automatically when you open it. Click the buttons on the front panel or use the keyboard shortcuts.
 10. Stop and close all VIs.

12.6 Editing VI Properties

Sometimes you can select VI properties that make it difficult to edit a VI. For example, you might select the Run When Opened option and disable the menu bar and toolbar. If you set the VI to close and exit LabVIEW after it runs, you cannot stop the VI and edit it without it closing and exiting LabVIEW. This VI would be very difficult to edit.

NOTE: To exit LabVIEW, you can use the Quit LabVIEW function located on the Functions»All Functions»Application Control palette. This function aborts all running VIs and ends the current session of LabVIEW. The function has one input. If it is wired, the end of the LabVIEW session occurs only if that input is True. If the input is not wired, the end of the session occurs when the node executes.

Before you change VI properties, save a backup of the VI to a new location by selecting File»Save with Options to avoid situations like the previous examples.

Select the Development Distribution option to save the VI to a new location along with its entire hierarchy. You also can include the vi.lib files in the save. After you save the backup VI, change the VI properties of the original VI. If you encounter a problem, you can return to the backup VI.

CAUTION: If you select the Remove diagrams option, you remove the source code of the VI. Select this option only if you never need to edit the VI again. Before you save a VI without the block diagrams, save a backup of the VI with the block diagrams.

If you already saved a development VI with properties that make the VI difficult to edit, refer to the Edit Me VI (Section 12.7) exercise for more information about editing the VI.

12.7 Edit Me VI

Exercise 12.3:

12.7.1 Front Panel

1. Close any open VIs and open the Edit Me VI, located in the C:\Exercises\LabVIEW Basics I directory. The following front panel is already built.



Figure 12.6

The VI is already running when it opens. While the VI runs, you cannot use the menu bar, toolbar, or keyboard shortcuts to edit or abort the VI.

2. Click the Start button. After 10 seconds, the VI stops running and quits LabVIEW.
3. Relaunch LabVIEW and open a blank VI.
4. If the VI you want to edit either does not have subVIs or you do not know what it contains, complete pg 253 through pg 253. However, if the VI you want to edit has subVIs, open one of the subVIs and modify the block diagram to break the subVI. For example, place an Add function on the block diagram and do not wire the inputs. Open the VI you want to edit. Because its subVI is nonexecutable, the VI that calls it is also nonexecutable. It opens in edit mode and the Run button appears broken. Make sure to fix the subVI after you edit the calling VI.
5. Display the block diagram of the new VI.
6. Place the Edit Me VI, which is already built, on the block diagram. The front panel for the Edit Me VI displays. Although you can display the block diagram of the Edit Me VI, you cannot edit it.
7. Select Operate>>Change to Edit Mode. A dialog box informs you that the VI is locked.
8. Click the Unlock button. You now can edit the VI. You also can unlock a VI by selecting File>>VI Properties and selecting Security from the Category pull-down menu.
9. Select and delete the Quit LabVIEW function from the block diagram.
10. Save and close the Edit Me VI. Close the new VI and do not save changes.
11. Open the Edit Me VI again.
12. After the VI runs, try to edit it.
13. Close the Edit Me VI.

12.8 Customizing the Controls and Functions Palettes

You can customize the Controls and Functions palettes to add VIs and controls to the palettes, hide VIs and functions, or rearrange the built-in palettes to make the VIs and functions you use frequently more accessible.

12.8.1 Adding VIs and Controls to the User Library and the Instrument Library

The simplest method for adding VIs and controls to the Controls and Functions palettes is to save them in the `labview\user.lib` directory. When you restart LabVIEW, the Functions»Express User Libraries and Controls»Express User Controls palettes contain subpalettes for each directory, VI library (.llb), or menu (.mnu) file in the `labview\user.lib` directory, and icons for each file in the `labview\user.lib` directory. After you add files to or remove files from specific directories, LabVIEW automatically updates the palettes when you restart LabVIEW.

The Functions»All Functions»Instrument I/O palette corresponds to the `labview\instr.lib` directory. Save instrument drivers in this directory to add them to the Functions palette.

When you add VIs or controls to the Controls and Functions palettes using this method, you cannot set the name of each subpalette or the exact location of the VIs or controls on the palettes.

12.8.2 Creating and Editing Custom Palette Views

To control the name of each subpalette and the exact location of the VIs and controls you add to the Controls and Functions palettes, you must create a custom palette view. LabVIEW includes two built-in palette views—Express and Advanced. Select Tools»Advanced»Edit Palette Views to create or edit custom palette views.

NOTE: You cannot edit a built-in palette view.

Refer to the *LabVIEW User Manual* and the *LabVIEW Help* for more information about palette views.

12.9 Summary, Tips, and Tricks on Customizing VIs

- Select File»VI Properties to configure the appearance and behavior of a VI. You also can right-click the VI icon on the front panel or block diagram and select VI Properties from the shortcut menu.
- If you want a single instance of the subVI to open its front panel when called, right-click the subVI and select SubVI Node Setup from the shortcut menu. Place checkmarks in the Show Front Panel when called and Close afterwards if originally closed checkboxes.
- If you want every instance of the subVI to open its front panel when called, select File»VI Properties and select Window Appearance from the Category pull-down menu. Click the Customize button and place checkmarks in the Show Front Panel When Called and Close Afterwards if Originally Closed checkboxes.
- Assign keyboard shortcuts to controls by right-clicking the control and selecting Advanced»Key Navigation from the shortcut menu.
- Before you change VI properties, save a backup of the VI to a new location by selecting File»Save with Options to avoid making the VI difficult to edit.

- To edit a VI with properties that make the VI difficult to edit:
 - Break one of its subVIs. The VI opens in edit mode because it cannot run with a broken subVI.
 - If the VI has no subVIs, place it on the block diagram of a new VI.
- The simplest method for adding VIs and controls to the Controls and Functions palettes is to save them in the user.lib directory.
- To create or edit a custom palette view, select Tools»Advanced»Edit Palette Views.
- Change to an icon- or text-only palette view by selecting from the Format pull-down menu.

Chapter 13

Appendix

13.1 Appendix

13.1.1 Additional Information

This section describes how you can receive more information regarding LabVIEW, instrument drivers, and other topics related to this course.

13.1.1.1 National Instruments Technical Support Options

The best way to get technical support and other information about LabVIEW, test and measurement, instrumentation, and other National Instruments products and services is the NI Web site at ni.com¹.

The support page for the National Instruments Web site contains links to application notes, the support KnowledgeBase, hundreds of examples, and troubleshooting wizards for all topics discussed in this course and more.

Another excellent place to obtain support while developing various applications with National Instruments products is the NI Developer Zone at ni.com/zone².

The NI Developer Zone also includes direct links to the instrument driver network and to Alliance Program member Web pages.

13.1.1.1.1 The Alliance Program

The National Instruments Alliance Program joins system integrators, consultants, and hardware vendors to provide comprehensive service and expertise to customers. The program ensures qualified, specialized assistance for application and system development. Information about and links to many of the Alliance Program members are available from the National Instruments Web site.

13.1.1.1.2 Other National Instruments Training Courses

National Instruments offers several training courses for LabVIEW users. The courses are listed in the National Instruments catalog and online at ni.com/training³. These courses continue the training you received here and expand it to other areas. You can either purchase the course materials or sign up for an instructor-led hands-on course by contacting National Instruments.

¹<http://ni.com>

²<http://ni.com/zone>

³<http://www.ni.com/training/>

13.1.1.2 LabVIEW Publications

13.1.1.2.1 LabVIEW Technical Resource (LTR) Newsletter

Subscribe to *LabVIEW Technical Resource* to discover power tips and techniques for developing LabVIEW applications. This quarterly publication offers detailed technical information for novice users as well as advanced users. In addition, every issue contains a disk of LabVIEW VIs and utilities that implement methods covered in that issue. To order *LabVIEW Technical Resource*, contact LTR publishing at (214) 706-0587 or visit www.ltrpub.com⁴.

13.1.1.2.2 LabVIEW Books

Many books have been written about LabVIEW programming and applications. The National Instruments Web site contains a list of all the LabVIEW books and links to places to purchase these books. Publisher information is also included so you can directly contact the publisher for more information on the contents and ordering information for LabVIEW and related computer-based measurement and automation books.

13.1.1.3 The info-labview Listserve

Info-labview is an email group of users from around the world who discuss LabVIEW issues. The list members can answer questions about building LabVIEW systems for particular applications, where to get instrument drivers or help with a device, and problems that appear.

Send subscription messages to the info-labview list processor at: listmanager@pica.army.mil

Send other administrative messages to the info-labview list maintainer at: info-labview-REQUEST@pica.army.mil

Post a message to subscribers at: info-labview@pica.army.mil

You may also want to search the ftp archives at: <ftp://ftp.pica.army.mil/pub/labview/>⁵

The archives contain a large set of donated VIs for doing a wide variety of tasks.

13.1.2 ASCII Character Code Equivalents Table

The table (pg 259) contains the hexadecimal, octal, and decimal code equivalents for ASCII character codes.

⁴<http://www.ltrpub.com>

⁵<http://cnx.org/content/m12308/latest/ftp://ftp.pica.army.mil/pub/labview/>

Hex	Octal	Decimal	ASCII	Hex	Octal	Decimal	ASCII
00	000	0	NUL	20	040	32	SP
01	001	1	SOH	21	041	33	!
02	002	2	STX	22	042	34	"
03	003	3	ETX	23	043	35	#
04	004	4	EOT	24	044	36	\$
05	005	5	ENQ	25	045	37	%
06	006	6	ACK	26	046	38	&
07	007	7	BEL	27	047	39	'
08	010	8	BS	28	050	40	(
09	011	9	HT	29	051	41)
0A	012	10	LF	2A	052	42	*
0B	013	11	VT	2B	053	43	+
0C	014	12	FF	2C	054	44	,
0D	015	13	CR	2D	055	45	-
0E	016	14	SO	2E	056	46	.
0F	017	15	SI	2F	057	47	/
10	020	16	DLE	30	060	48	0
11	021	17	DC1	31	061	49	1
12	022	18	DC2	32	062	50	2
13	023	19	DC3	33	063	51	3
14	024	20	DC4	34	064	52	4
15	025	21	NAK	35	065	53	5
16	026	22	SYN	36	066	54	6
17	027	23	ETB	37	067	55	7
18	030	24	CAN	38	070	56	8
19	031	25	EM	39	071	57	9
1A	032	26	SUB	3A	072	58	:
1B	033	27	ESC	3B	073	59	;
1C	034	28	FS	3C	074	60	<
1D	035	29	GS	3D	075	61	=
1E	036	30	RS	3E	076	62	>
1F	037	31	US	3F	077	63	?
40	100	64	@	60	140	93	'
41	101	65	A	61	141	97	a
42	102	66	B	62	142	98	b
43	103	67	C	63	143	99	c
44	104	68	D	64	144	100	d
45	105	69	E	65	145	101	e
46	106	70	F	66	146	102	f
47	107	71	G	67	147	103	g
48	110	72	H	68	150	104	h
49	111	73	I	69	151	105	i
4A	112	74	J	6A	152	106	j
4B	113	75	K	6B	153	107	k
4C	114	76	L	6C	154	108	l
4D	115	77	M	6D	155	109	m
4E	116	78	N	6E	156	110	n
4F	117	79	O	6F	157	111	o

Hex	Octal	Decimal	ASCII		Hex	Octal	Decimal	ASCII
50	120	80	P		70	160	112	p
51	121	81	Q		71	161	113	q
52	122	82	R		72	162	114	r
53	123	83	S		73	163	115	s
54	124	84	T		74	164	116	t
55	125	85	U		75	165	117	u
56	126	86	V		76	166	118	v
57	127	87	W		77	167	119	w
58	130	88	X		78	170	120	x
59	131	89	Y		79	171	121	y
5A	132	90	Z		7A	172	122	z
5B	133	91	[7B	173	123	{
5C	134	92	\		7C	174	124	
5D	135	93]		7D	175	125	}
5E	136	94	^		7E	176	126	
5F	137	95	_		7F	177	127	DEL

13.1.3 Instructor Notes

1. Make sure each station has the following components:
 - *LabVIEW Basics I: Introduction Course Manual*
 - LabVIEW Professional Development System 7.0 or later
 - Multifunction DAQ device configured as Board ID 1
 - DAQ Signal Accessory and cable to connect the DAQ device to the DAQ Signal Accessory
 - GPIB interface
 - NI Instrument Simulator, power supply, GPIB cable to connect the GPIB interface to the NI Instrument Simulator, and serial cable to connect the computer to the NI Instrument Simulator
 - Wires (two per station)
2. Copy the files from the CD accompanying this manual as described in the *Installing the Course Software* section of the *Student Guide* and the readme.txt file on the disks.
3. Test the station by starting LabVIEW by selecting Start»Programs»Station Tests»LV Station Test to run the LV Station Test VI. Refer to the customer education resources coordinator for this VI.
4. Open MAX to verify that both the DAQ device and GPIB interface are working properly.
5. Verify that the NI DEVSIM instrument driver is installed and that the NI Instrument Simulator works in both the GPIB and serial modes.

Glossary

T task

A collection of one or more channels and the timing, triggering, and other properties that apply to the task itself. A task represents a measurement or generation you want to perform.

V virtual channels

A collection of property settings that include a physical channel, the type

of measurement or generation specified in the channel name, and scaling information

VISA

Virtual Instrument Software Architecture (VISA) is the lower layer of functions in the LabVIEW instrument driver VIs that communicates with the driver software.

Index of Keywords and Terms

Keywords are listed by the section with that keyword (page numbers are in parentheses). Keywords do not necessarily appear in the text of the page. They are merely associated with that section. *Ex.* apples, § 1.1 (1) **Terms** are referenced by the page they appear on. *Ex.* apples, 1

- A** Acquiring a Signal VI, § 2.5(27)
 analog, § 10.4(195)
 analog input, § 10.4(195)
 analog output, § 10.9(204)
 ANSI/IEEE Standard 488.1-1987, 213
 appearance, § 12.1(245)
 array, § 5.3(94)
 Array Exercise VI, § 5.5(97)
 Array Functions, § 5.3(94)
 Arrays, § 5.1(91), § 5.1(91), 91, § 5.6(98), § 5.6(98), 98, § 5.7(99)
 ASCII, § 13.1(257)
 auto, § 5.2(93)
 Auto-Indexing, § 5.2(93), § 5.2(93)
- B** block diagram, 5, § 2.4(22), § 2.4(22)
- C** Case, § 8.7(155), § 8.8(156)
 case structure, § 8.2(144)
 channels, 190
 Cluster Exercise VI, § 6.3(105)
 Cluster Functions, § 6.2(103), § 6.2(103)
 Cluster Scaling VI, § 6.4(108)
 clusters, 91, § 6.1(101), § 6.1(101), 101, § 6.6(111), 111
 code, 110, 111
 connector pane, 5, 61
 Controls, § 12.4(250)
 counter, § 10.11(208), § 10.12(209)
 Customizing, § 12.8(254), § 12.9(254)
- D** DAQ, § 10.1(187), § 10.3(194), § 10.15(211), § 10.16(212)
 data, § 10.7(200)
 Data Acquisition, § 10.3(194)
 Data Communications Equipment, 231
 Data Format, 241
 Data Source, 241
 Data Terminal Equipment, 231
 Dataflow Programming, § 2.6(37)
 DCE, 231
- Debug, § 2.11(49)
 Debugging Techniques, § 2.10(48), § 2.10(48)
 decision, § 8.1(143)
 Digital, § 10.13(210), § 10.14(210)
 Documentation Resources, § 2.8(39), § 2.8(39)
 driver, § 11.8(224)
 DTE, 231
- E** EIA, 231
 Electronic Industries Association, 231
 environment, § 2.2(5)
 Error Clusters, § 6.5(109), § 6.5(109)
 exercise, § 2.5(27), § 2.7(38), § 2.9(42), § 2.11(49), § 5.5(97), § 5.7(99), § 6.3(105), § 6.4(108), § 7.2(115), § 7.3(121), § 7.7(135), § 7.9(138), § 7.11(140), § 8.3(148), § 8.4(150), § 8.6(154), § 8.8(156), § 9.3(162), § 9.8(173), § 9.9(175), § 9.11(180), § 9.12(184), § 9.14(186), § 10.5(197), § 10.6(199), § 10.10(205), § 10.12(209), § 10.14(210), § 10.16(212), § 11.3(216), § 11.5(219), § 11.7(222), § 11.10(227), § 11.12(234), § 11.14(240), § 11.16(243), § 12.3(247), § 12.5(250), § 12.7(253)
 exercise VI, § 10.8(201)
 Exercises, § 1.1(1)
 Express Filter VI, § 2.7(38)
- F** Feedback Node, 83
 formula node, § 8.6(154), § 8.7(155), § 8.8(156)
 front panel, 5, § 2.3(19), § 2.3(19), § 12.2(247)
 functions, § 5.3(94)
- G** General Purpose Interface Bus, 213
 GPIB, § 11.2(213), 213, § 11.3(216)
 Graph Circle VI, § 7.7(135)

- Graphical, § 1.1(1)
- I** I/O, § 9.4(165), § 9.5(167), § 9.13(185)
 - icon, 5
 - indexing, § 5.2(93)
 - Info-labview, 258
 - Instrument Control, § 11.1(213), § 11.15(243)
 - Instrument Driver, § 11.9(224)
 - Instrument Drivers, § 11.8(224)
 - Instrument I/O, § 11.4(218), § 11.5(219)
 - Instrument I/O Assistant, § 11.4(218), § 11.5(219)
 - Intensity Graph Example VI, § 7.9(138)
 - IO, § 9.7(171)
- L** LabVIEW, § 1.1(1), § 2.1(5), § 2.2(5), § 2.3(19), § 2.4(22), § 2.5(27), § 2.6(37), § 2.7(38), § 2.8(39), § 2.9(42), § 2.10(48), § 2.11(49), § 2.12(52), § 5.1(91), § 5.2(93), § 5.3(94), § 5.4(96), § 5.5(97), § 5.6(98), § 5.7(99), § 6.1(101), § 6.2(103), § 6.3(105), § 6.4(108), § 6.5(109), § 6.6(111), § 7.2(115), § 7.3(121), § 7.7(135), § 7.9(138), § 7.11(140), § 8.1(143), § 8.2(144), § 8.3(148), § 8.4(150), § 8.5(153), § 8.6(154), § 8.7(155), § 8.8(156), § 9.1(157), § 9.2(159), § 9.3(162), § 9.4(165), § 9.5(167), § 9.6(168), § 9.7(171), § 9.8(173), § 9.9(175), § 9.10(177), § 9.11(180), § 9.12(184), § 9.13(185), § 9.14(186), § 10.1(187), § 10.2(191), § 10.3(194), § 10.4(195), § 10.5(197), § 10.6(199), § 10.7(200), § 10.8(201), § 10.9(204), § 10.10(205), § 10.11(208), § 10.12(209), § 10.13(210), § 10.14(210), § 10.15(211), § 10.16(212), § 11.1(213), § 11.2(213), § 11.3(216), § 11.4(218), § 11.5(219), § 11.6(220), § 11.7(222), § 11.8(224), § 11.9(224), § 11.10(227), § 11.11(229), § 11.12(234), § 11.13(237), § 11.14(240), § 11.15(243), § 11.16(243), § 12.1(245), § 12.2(247), § 12.3(247), § 12.4(250), § 12.5(250), § 12.6(252), § 12.7(253), § 12.8(254), § 12.9(254), § 13.1(257)
 - LabVIEW Environment, § 2.2(5)
 - lesson one, § 2.12(52)
- M** MAX, § 10.2(191), § 11.3(216)
 - Measurement Averaging, § 10.6(199)
- N** National Instrument, § 9.2(159), § 10.14(210)
 - National Instruments, § 2.1(5), § 2.2(5), § 2.3(19), § 2.4(22), § 2.5(27), § 2.6(37), § 2.7(38), § 2.8(39), § 2.9(42), § 2.10(48), § 2.11(49), § 2.12(52), § 5.1(91), § 5.2(93), § 5.3(94), § 5.4(96), § 5.5(97), § 5.6(98), § 5.7(99), § 6.1(101), § 6.2(103), § 6.3(105), § 6.4(108), § 6.5(109), § 6.6(111), § 7.2(115), § 7.3(121), § 7.7(135), § 7.9(138), § 7.11(140), § 8.1(143), § 8.2(144), § 8.3(148), § 8.4(150), § 8.5(153), § 8.6(154), § 8.7(155), § 8.8(156), § 9.1(157), § 9.3(162), § 9.4(165), § 9.5(167), § 9.6(168), § 9.7(171), § 9.8(173), § 9.9(175), § 9.10(177), § 9.11(180), § 9.12(184), § 9.13(185), § 9.14(186), § 10.1(187), § 10.2(191), § 10.3(194), § 10.4(195), § 10.5(197), § 10.6(199), § 10.7(200), § 10.8(201), § 10.9(204), § 10.10(205), § 10.11(208), § 10.12(209), § 10.13(210), § 10.15(211), § 10.16(212), § 11.1(213), § 11.2(213), § 11.3(216), § 11.4(218), § 11.5(219), § 11.6(220), § 11.7(222), § 11.8(224), § 11.9(224), § 11.10(227), § 11.11(229), § 11.12(234), § 11.13(237), § 11.14(240), § 11.15(243), § 11.16(243), § 12.1(245), § 12.2(247), § 12.3(247), § 12.4(250), § 12.5(250), § 12.6(252), § 12.7(253), § 12.8(254), § 12.9(254), § 13.1(257)
 - node, § 8.5(153)
- P** PAD, 217
 - palettes, § 12.8(254)
 - plotting data, § 7.11(140)
 - Polymorphism, § 5.4(96), § 5.4(96), 99
 - pop-up graph, § 12.3(247)
 - primary address, 217
 - Programming, § 1.1(1)
- R** Reduce Samples VI, § 2.9(42)
 - RS-232, 231
- S** select, § 8.1(143), § 8.7(155), § 8.8(156)
 - Serial Port, § 11.11(229)
 - Serial Read, § 11.12(234)
 - Serial Write, § 11.12(234)
 - shift register, 83
 - Shortcuts, § 12.4(250)
 - Solutions, § 1.1(1)

- source, 110, 111
 - spreadsheet, § 9.6(168), § 9.10(177)
 - status, 110, 110, 111
 - string, § 9.1(157), § 9.2(159), § 9.3(162), § 9.10(177), § 9.13(185)
 - string function, § 9.2(159)
 - SubVI, § 12.2(247)
 - subVIs, § 3.4(66)
 - summary, § 2.12(52), § 5.6(98), § 6.6(111), § 12.9(254)
- T**
- task, 190
 - tasks, 190
 - Temperature Monitor, § 7.2(115)
 - Temperature Running Average VI, § 7.3(121)
 - Temperature System, § 12.5(250)
 - The Alliance Program, § 13.1(257)
 - tips, § 2.12(52), § 5.6(98), § 6.6(111), § 11.15(243)
 - training, § 13.1(257)
 - tricks, § 2.12(52), § 5.6(98), § 6.6(111)
 - triggers, 197
- U**
- UNIX, 246
- V**
- VI, § 8.3(148), § 8.4(150), § 9.8(173), § 9.9(175), § 9.11(180), § 9.12(184), § 9.14(186), § 10.5(197), § 10.6(199), § 10.12(209), § 10.14(210), § 11.9(224), § 11.10(227), § 11.14(240), § 11.16(243), § 12.3(247), § 12.5(250), § 12.6(252), § 12.7(253), § 12.9(254)
 - VI properties, § 12.6(252)
 - virtual channels, 190
 - Virtual Instrument Software Architecture, § 11.6(220)
 - virtual instruments, 5
 - VIs, 5
 - VISA, § 11.6(220), 221, § 11.7(222)
 - voltage output, § 10.10(205)
 - Voltmeter, § 10.5(197)
- W**
- waveform chart, 113
 - waveform transfer, § 11.13(237)
 - waveforms, § 11.14(240)

Attributions

Collection: LabVIEW Graphical Programming Course
Edited by: National Instruments
URL: <http://cnx.org/content/col10241/1.4/>
License: <http://creativecommons.org/licenses/by/1.0>

Module: LabVIEW Course Exercise Code
By: National Instruments
URL: <http://cnx.org/content/m14634/latest/>
Copyright: National Instruments
License: <http://creativecommons.org/licenses/by/2.0/>

Module: LabVIEW
By: National Instruments
URL: <http://cnx.org/content/m12192/latest/>
Copyright: National Instruments
License: <http://creativecommons.org/licenses/by/1.0>

Module: LabVIEW Environment
By: National Instruments
URL: <http://cnx.org/content/m12193/latest/>
Copyright: National Instruments
License: <http://creativecommons.org/licenses/by/1.0>

Module: Front Panel
By: National Instruments
URL: <http://cnx.org/content/m12194/latest/>
Copyright: National Instruments
License: <http://creativecommons.org/licenses/by/1.0>

Module: Block Diagram
By: National Instruments
URL: <http://cnx.org/content/m12195/latest/>
Copyright: National Instruments
License: <http://creativecommons.org/licenses/by/1.0>

Module: Acquiring a Signal VI
By: National Instruments
URL: <http://cnx.org/content/m12196/latest/>
Copyright: National Instruments
License: <http://creativecommons.org/licenses/by/1.0>

Module: Dataflow Programming
By: National Instruments
URL: <http://cnx.org/content/m12197/latest/>
Copyright: National Instruments
License: <http://creativecommons.org/licenses/by/1.0>

Module: Express Filter VI

By: National Instruments
URL: <http://cnx.org/content/m12198/latest/>
Copyright: National Instruments
License: <http://creativecommons.org/licenses/by/1.0>

Module: LabVIEW Documentation Resources
By: National Instruments
URL: <http://cnx.org/content/m12199/latest/>
Copyright: National Instruments
License: <http://creativecommons.org/licenses/by/1.0>

Module: Reduce Samples VI
By: Malan Shiralkar
URL: <http://cnx.org/content/m12200/latest/>
Copyright: Malan Shiralkar
License: <http://creativecommons.org/licenses/by/1.0>

Module: Debugging Techniques
By: National Instruments
URL: <http://cnx.org/content/m12201/latest/>
Copyright: National Instruments
License: <http://creativecommons.org/licenses/by/1.0>

Module: Debug Exercise (Main) VI
By: National Instruments
URL: <http://cnx.org/content/m12202/latest/>
Copyright: National Instruments
License: <http://creativecommons.org/licenses/by/1.0>

Module: Summary, Tips, and Tricks on Introduction to LabVIEW
By: National Instruments
URL: <http://cnx.org/content/m12203/latest/>
Copyright: National Instruments
License: <http://creativecommons.org/licenses/by/1.0>

Module: Modular Programming
By: National Instruments
URL: <http://cnx.org/content/m12204/latest/>
Copyright: National Instruments
License: <http://creativecommons.org/licenses/by/1.0>

Module: Icons and Connector Panes
By: National Instruments
URL: <http://cnx.org/content/m12205/latest/>
Copyright: National Instruments
License: <http://creativecommons.org/licenses/by/1.0>

Module: Convert C to F VI
By: National Instruments
URL: <http://cnx.org/content/m12207/latest/>
Copyright: National Instruments

License: <http://creativecommons.org/licenses/by/1.0>

Module: Using SubVIs

By: National Instruments

URL: <http://cnx.org/content/m12208/latest/>

Copyright: National Instruments

License: <http://creativecommons.org/licenses/by/1.0>

Module: Thermometer VI

By: National Instruments

URL: <http://cnx.org/content/m12209/latest/>

Copyright: National Instruments

License: <http://creativecommons.org/licenses/by/1.0>

Module: Creating a SubVI from Sections of a VI

By: National Instruments

URL: <http://cnx.org/content/m12210/latest/>

Copyright: National Instruments

License: <http://creativecommons.org/licenses/by/1.0>

Module: Summary, Tips, and Tricks on Modular Programming

By: National Instruments

URL: <http://cnx.org/content/m12211/latest/>

Copyright: National Instruments

License: <http://creativecommons.org/licenses/by/1.0>

Module: While Loops

By: National Instruments

URL: <http://cnx.org/content/m12212/latest/>

Copyright: National Instruments

License: <http://creativecommons.org/licenses/by/1.0>

Module: Auto Match VI

By: National Instruments

URL: <http://cnx.org/content/m12213/latest/>

Copyright: National Instruments

License: <http://creativecommons.org/licenses/by/1.0>

Module: For Loops

By: National Instruments

URL: <http://cnx.org/content/m12214/latest/>

Copyright: National Instruments

License: <http://creativecommons.org/licenses/by/1.0>

Module: Timed Temperature VI

By: National Instruments

URL: <http://cnx.org/content/m12216/latest/>

Copyright: National Instruments

License: <http://creativecommons.org/licenses/by/1.0>

Module: Accessing Previous Loop Data

By: National Instruments
URL: <http://cnx.org/content/m12217/latest/>
Copyright: National Instruments
License: <http://creativecommons.org/licenses/by/1.0>

Module: Accessing Previous Data VI
By: National Instruments
URL: <http://cnx.org/content/m12218/latest/>
Copyright: National Instruments
License: <http://creativecommons.org/licenses/by/1.0>

Module: Summary, Tips, and Tricks on Repetition and Loops
By: National Instruments
URL: <http://cnx.org/content/m12219/latest/>
Copyright: National Instruments
License: <http://creativecommons.org/licenses/by/1.0>

Module: Arrays
By: National Instruments
URL: <http://cnx.org/content/m12220/latest/>
Copyright: National Instruments
License: <http://creativecommons.org/licenses/by/1.0>

Module: Auto-Indexing
By: National Instruments
URL: <http://cnx.org/content/m12221/latest/>
Copyright: National Instruments
License: <http://creativecommons.org/licenses/by/1.0>

Module: Array Functions
By: National Instruments
URL: <http://cnx.org/content/m12222/latest/>
Copyright: National Instruments
License: <http://creativecommons.org/licenses/by/1.0>

Module: Polymorphism
By: National Instruments
URL: <http://cnx.org/content/m12223/latest/>
Copyright: National Instruments
License: <http://creativecommons.org/licenses/by/1.0>

Module: Array Exercise VI
By: National Instruments
URL: <http://cnx.org/content/m12224/latest/>
Copyright: National Instruments
License: <http://creativecommons.org/licenses/by/1.0>

Module: Summary, Tips, and Tricks on Arrays
By: National Instruments
URL: <http://cnx.org/content/m12225/latest/>
Copyright: National Instruments

License: <http://creativecommons.org/licenses/by/1.0>

Module: Additional Exercises for Arrays

By: National Instruments

URL: <http://cnx.org/content/m12226/latest/>

Copyright: National Instruments

License: <http://creativecommons.org/licenses/by/1.0>

Module: Clusters

By: National Instruments

URL: <http://cnx.org/content/m12227/latest/>

Copyright: National Instruments

License: <http://creativecommons.org/licenses/by/1.0>

Module: Cluster Functions

By: National Instruments

URL: <http://cnx.org/content/m12228/latest/>

Copyright: National Instruments

License: <http://creativecommons.org/licenses/by/1.0>

Module: Cluster Exercise VI

By: National Instruments

URL: <http://cnx.org/content/m12229/latest/>

Copyright: National Instruments

License: <http://creativecommons.org/licenses/by/1.0>

Module: Cluster Scaling VI

By: National Instruments

URL: <http://cnx.org/content/m12230/latest/>

Copyright: National Instruments

License: <http://creativecommons.org/licenses/by/1.0>

Module: Error Clusters

By: National Instruments

URL: <http://cnx.org/content/m12231/latest/>

Copyright: National Instruments

License: <http://creativecommons.org/licenses/by/1.0>

Module: Summary, Tips, and Tricks on Clusters

By: National Instruments

URL: <http://cnx.org/content/m12232/latest/>

Copyright: National Instruments

License: <http://creativecommons.org/licenses/by/1.0>

Module: Waveform Charts

By: National Instruments

URL: <http://cnx.org/content/m12233/latest/>

Copyright: National Instruments

License: <http://creativecommons.org/licenses/by/1.0>

Module: Temperature Monitor VI

By: National Instruments
URL: <http://cnx.org/content/m12234/latest/>
Copyright: National Instruments
License: <http://creativecommons.org/licenses/by/1.0>

Module: Temperature Running Average VI
By: National Instruments
URL: <http://cnx.org/content/m12235/latest/>
Copyright: National Instruments
License: <http://creativecommons.org/licenses/by/1.0>

Module: Waveform and XY Graphs
By: National Instruments
URL: <http://cnx.org/content/m12236/latest/>
Copyright: National Instruments
License: <http://creativecommons.org/licenses/by/1.0>

Module: Graph Waveform Array VI
By: National Instruments
URL: <http://cnx.org/content/m12237/latest/>
Copyright: National Instruments
License: <http://creativecommons.org/licenses/by/1.0>

Module: Temperature Analysis VI
By: National Instruments
URL: <http://cnx.org/content/m12238/latest/>
Copyright: National Instruments
License: <http://creativecommons.org/licenses/by/1.0>

Module: Graph Circle VI
By: National Instruments
URL: <http://cnx.org/content/m12239/latest/>
Copyright: National Instruments
License: <http://creativecommons.org/licenses/by/1.0>

Module: Intensity Plots
By: National Instruments
URL: <http://cnx.org/content/m12240/latest/>
Copyright: National Instruments
License: <http://creativecommons.org/licenses/by/1.0>

Module: Intensity Graph Example VI
By: National Instruments
URL: <http://cnx.org/content/m12241/latest/>
Copyright: National Instruments
License: <http://creativecommons.org/licenses/by/1.0>

Module: Summary, Tips, and Tricks on Plotting Data
By: National Instruments
URL: <http://cnx.org/content/m12242/latest/>
Copyright: National Instruments

License: <http://creativecommons.org/licenses/by/1.0>

Module: Additional Exercises for Plotting Data

By: National Instruments

URL: <http://cnx.org/content/m12243/latest/>

Copyright: National Instruments

License: <http://creativecommons.org/licenses/by/1.0>

Module: Making Decisions with the Select Function

By: National Instruments

URL: <http://cnx.org/content/m12244/latest/>

Copyright: National Instruments

License: <http://creativecommons.org/licenses/by/1.0>

Module: Case Structures

By: National Instruments

URL: <http://cnx.org/content/m12245/latest/>

Copyright: National Instruments

License: <http://creativecommons.org/licenses/by/1.0>

Module: Square Root VI

By: National Instruments

URL: <http://cnx.org/content/m12246/latest/>

Copyright: National Instruments

License: <http://creativecommons.org/licenses/by/1.0>

Module: Temperature Control VI

By: National Instruments

URL: <http://cnx.org/content/m12247/latest/>

Copyright: National Instruments

License: <http://creativecommons.org/licenses/by/1.0>

Module: Formula Node

By: National Instruments

URL: <http://cnx.org/content/m12248/latest/>

Copyright: National Instruments

License: <http://creativecommons.org/licenses/by/1.0>

Module: Formula Node Exercise VI

By: National Instruments

URL: <http://cnx.org/content/m12249/latest/>

Copyright: National Instruments

License: <http://creativecommons.org/licenses/by/1.0>

Module: Summary, Tips, and Tricks on Making Decisions in a VI

By: National Instruments

URL: <http://cnx.org/content/m12250/latest/>

Copyright: National Instruments

License: <http://creativecommons.org/licenses/by/1.0>

Module: Additional Exercises for Making Decisions in a VI

By: National Instruments
URL: <http://cnx.org/content/m12251/latest/>
Copyright: National Instruments
License: <http://creativecommons.org/licenses/by/1.0>

Module: Strings
By: National Instruments
URL: <http://cnx.org/content/m12252/latest/>
Copyright: National Instruments
License: <http://creativecommons.org/licenses/by/1.0>

Module: String Functions
By: National Instruments
URL: <http://cnx.org/content/m12253/latest/>
Copyright: National Instruments
License: <http://creativecommons.org/licenses/by/1.0>

Module: Create String VI
By: National Instruments
URL: <http://cnx.org/content/m12254/latest/>
Copyright: National Instruments
License: <http://creativecommons.org/licenses/by/1.0>

Module: File I/O VIs and Functions
By: National Instruments
URL: <http://cnx.org/content/m12255/latest/>
Copyright: National Instruments
License: <http://creativecommons.org/licenses/by/1.0>

Module: High-Level File I/O VIs
By: National Instruments
URL: <http://cnx.org/content/m12256/latest/>
Copyright: National Instruments
License: <http://creativecommons.org/licenses/by/1.0>

Module: Spreadsheet Example VI
By: National Instruments
URL: <http://cnx.org/content/m12257/latest/>
Copyright: National Instruments
License: <http://creativecommons.org/licenses/by/1.0>

Module: Low-Level File I/O VI and Functions
By: National Instruments
URL: <http://cnx.org/content/m12258/latest/>
Copyright: National Instruments
License: <http://creativecommons.org/licenses/by/1.0>

Module: File Writer VI
By: National Instruments
URL: <http://cnx.org/content/m12259/latest/>
Copyright: National Instruments

License: <http://creativecommons.org/licenses/by/1.0>

Module: File Reader VI

By: National Instruments

URL: <http://cnx.org/content/m12260/latest/>

Copyright: National Instruments

License: <http://creativecommons.org/licenses/by/1.0>

Module: Formatting Spreadsheet Strings

By: National Instruments

URL: <http://cnx.org/content/m12261/latest/>

Copyright: National Instruments

License: <http://creativecommons.org/licenses/by/1.0>

Module: Temperature Logger VI

By: National Instruments

URL: <http://cnx.org/content/m12262/latest/>

Copyright: National Instruments

License: <http://creativecommons.org/licenses/by/1.0>

Module: Temperature Application VI

By: National Instruments

URL: <http://cnx.org/content/m12263/latest/>

Copyright: National Instruments

License: <http://creativecommons.org/licenses/by/1.0>

Module: Summary, Tips, and Tricks on Strings and File I/O

By: National Instruments

URL: <http://cnx.org/content/m12264/latest/>

Copyright: National Instruments

License: <http://creativecommons.org/licenses/by/1.0>

Module: Additional Exercises for Strings and FileI/O

By: National Instruments

URL: <http://cnx.org/content/m12265/latest/>

Copyright: National Instruments

License: <http://creativecommons.org/licenses/by/1.0>

Module: Overview and Configuration of DAQ Devices

By: National Instruments

URL: <http://cnx.org/content/m12266/latest/>

Copyright: National Instruments

License: <http://creativecommons.org/licenses/by/1.0>

Module: Measurement & Automation Explorer (Windows Only)

By: National Instruments

URL: <http://cnx.org/content/m12267/latest/>

Copyright: National Instruments

License: <http://creativecommons.org/licenses/by/1.0>

Module: Data Acquisition in LabVIEW

By: National Instruments
URL: <http://cnx.org/content/m12268/latest/>
Copyright: National Instruments
License: <http://creativecommons.org/licenses/by/1.0>

Module: Analog Input
By: National Instruments
URL: <http://cnx.org/content/m12269/latest/>
Copyright: National Instruments
License: <http://creativecommons.org/licenses/by/1.0>

Module: Voltmeter VI
By: National Instruments
URL: <http://cnx.org/content/m12270/latest/>
Copyright: National Instruments
License: <http://creativecommons.org/licenses/by/1.0>

Module: Measurement Averaging VI
By: National Instruments
URL: <http://cnx.org/content/m12271/latest/>
Copyright: National Instruments
License: <http://creativecommons.org/licenses/by/1.0>

Module: Data Logging
By: National Instruments
URL: <http://cnx.org/content/m12272/latest/>
Copyright: National Instruments
License: <http://creativecommons.org/licenses/by/1.0>

Module: Simple Data Logger VI
By: National Instruments
URL: <http://cnx.org/content/m12273/latest/>
Copyright: National Instruments
License: <http://creativecommons.org/licenses/by/1.0>

Module: Analog Output
By: National Instruments
URL: <http://cnx.org/content/m12274/latest/>
Copyright: National Instruments
License: <http://creativecommons.org/licenses/by/1.0>

Module: Voltage Output VI
By: National Instruments
URL: <http://cnx.org/content/m12275/latest/>
Copyright: National Instruments
License: <http://creativecommons.org/licenses/by/1.0>

Module: Counters
By: National Instruments
URL: <http://cnx.org/content/m12276/latest/>
Copyright: National Instruments

License: <http://creativecommons.org/licenses/by/1.0>

Module: Simple Event Counting VI
By: National Instruments
URL: <http://cnx.org/content/m12277/latest/>
Copyright: National Instruments
License: <http://creativecommons.org/licenses/by/1.0>

Module: Digital I/O
By: National Instruments
URL: <http://cnx.org/content/m12278/latest/>
Copyright: National Instruments
License: <http://creativecommons.org/licenses/by/1.0>

Module: Digital Example VI
By: National Instruments
URL: <http://cnx.org/content/m12279/latest/>
Copyright: National Instruments
License: <http://creativecommons.org/licenses/by/1.0>

Module: Summary, Tips, and Tricks on Data Acquisition and Waveforms
By: National Instruments
URL: <http://cnx.org/content/m12280/latest/>
Copyright: National Instruments
License: <http://creativecommons.org/licenses/by/1.0>

Module: Additional Exercises for Data Acquisition and Waveforms
By: National Instruments
URL: <http://cnx.org/content/m12281/latest/>
Copyright: National Instruments
License: <http://creativecommons.org/licenses/by/1.0>

Module: Instrument Control Overview
By: National Instruments
URL: <http://cnx.org/content/m12282/latest/>
Copyright: National Instruments
License: <http://creativecommons.org/licenses/by/1.0>

Module: GPIB Communication and Configuration
By: National Instruments
URL: <http://cnx.org/content/m12283/latest/>
Copyright: National Instruments
License: <http://creativecommons.org/licenses/by/1.0>

Module: GPIB Configuration with MAX (Windows Only)
By: National Instruments
URL: <http://cnx.org/content/m12285/latest/>
Copyright: National Instruments
License: <http://creativecommons.org/licenses/by/1.0>

Module: Using the Instrument I/O Assistant

By: National Instruments
URL: <http://cnx.org/content/m12286/latest/>
Copyright: National Instruments
License: <http://creativecommons.org/licenses/by/1.0>

Module: Using the Instrument I/O Assistant Exercise
By: National Instruments
URL: <http://cnx.org/content/m12287/latest/>
Copyright: National Instruments
License: <http://creativecommons.org/licenses/by/1.0>

Module: VISA
By: National Instruments
URL: <http://cnx.org/content/m12288/latest/>
Copyright: National Instruments
License: <http://creativecommons.org/licenses/by/1.0>

Module: Programming with VISA
By: National Instruments
URL: <http://cnx.org/content/m12289/latest/>
Copyright: National Instruments
License: <http://creativecommons.org/licenses/by/1.0>

Module: About Instrument Drivers
By: National Instruments
URL: <http://cnx.org/content/m12290/latest/>
Copyright: National Instruments
License: <http://creativecommons.org/licenses/by/1.0>

Module: Using Instrument Driver VIs
By: National Instruments
URL: <http://cnx.org/content/m12291/latest/>
Copyright: National Instruments
License: <http://creativecommons.org/licenses/by/1.0>

Module: Voltage Monitor VI
By: National Instruments
URL: <http://cnx.org/content/m12292/latest/>
Copyright: National Instruments
License: <http://creativecommons.org/licenses/by/1.0>

Module: Serial Port Communication
By: National Instruments
URL: <http://cnx.org/content/m12293/latest/>
Copyright: National Instruments
License: <http://creativecommons.org/licenses/by/1.0>

Module: Serial Write & Read VI
By: National Instruments
URL: <http://cnx.org/content/m12294/latest/>
Copyright: National Instruments

License: <http://creativecommons.org/licenses/by/1.0>

Module: Waveform Transfers

By: National Instruments

URL: <http://cnx.org/content/m12295/latest/>

Copyright: National Instruments

License: <http://creativecommons.org/licenses/by/1.0>

Module: Waveform Example VI

By: National Instruments

URL: <http://cnx.org/content/m12296/latest/>

Copyright: National Instruments

License: <http://creativecommons.org/licenses/by/1.0>

Module: Summary, Tips, and Tricks on Instrument Control

By: National Instruments

URL: <http://cnx.org/content/m12297/latest/>

Copyright: National Instruments

License: <http://creativecommons.org/licenses/by/1.0>

Module: Additional Exercises for Instrument Control

By: National Instruments

URL: <http://cnx.org/content/m12298/latest/>

Copyright: National Instruments

License: <http://creativecommons.org/licenses/by/1.0>

Module: Configuring the Appearance of Front Panels

By: National Instruments

URL: <http://cnx.org/content/m12299/latest/>

Copyright: National Instruments

License: <http://creativecommons.org/licenses/by/1.0>

Module: Opening SubVI Front Panels when a VI Runs

By: National Instruments

URL: <http://cnx.org/content/m12300/latest/>

Copyright: National Instruments

License: <http://creativecommons.org/licenses/by/1.0>

Module: Pop-up Graph VI and Use Pop-up Graph VI

By: National Instruments

URL: <http://cnx.org/content/m12301/latest/>

Copyright: National Instruments

License: <http://creativecommons.org/licenses/by/1.0>

Module: Keyboard Shortcuts for Controls

By: National Instruments

URL: <http://cnx.org/content/m12302/latest/>

Copyright: National Instruments

License: <http://creativecommons.org/licenses/by/1.0>

Module: Temperature System VI

By: National Instruments
URL: <http://cnx.org/content/m12303/latest/>
Copyright: National Instruments
License: <http://creativecommons.org/licenses/by/1.0>

Module: Editing VI Properties
By: National Instruments
URL: <http://cnx.org/content/m12304/latest/>
Copyright: National Instruments
License: <http://creativecommons.org/licenses/by/1.0>

Module: Edit Me VI
By: National Instruments
URL: <http://cnx.org/content/m12305/latest/>
Copyright: National Instruments
License: <http://creativecommons.org/licenses/by/1.0>

Module: Customizing the Controls and Functions Palettes
By: National Instruments
URL: <http://cnx.org/content/m12306/latest/>
Copyright: National Instruments
License: <http://creativecommons.org/licenses/by/1.0>

Module: Summary, Tips, and Tricks on Customizing VIs
By: National Instruments
URL: <http://cnx.org/content/m12307/latest/>
Copyright: National Instruments
License: <http://creativecommons.org/licenses/by/1.0>

Module: Appendix
By: National Instruments
URL: <http://cnx.org/content/m12308/latest/>
Copyright: National Instruments
License: <http://creativecommons.org/licenses/by/1.0>

LabVIEW Graphical Programming Course

Introduction to LabVIEW

About Connexions

Since 1999, Connexions has been pioneering a global system where anyone can create course materials and make them fully accessible and easily reusable free of charge. We are a web-based authoring, teaching and learning environment open to anyone interested in education, including students, teachers, professors and lifelong learners. We connect ideas and facilitate educational communities.

Connexions modular, interactive courses are in use worldwide by universities, community colleges, K-12 schools, distance learners, and lifelong learners. Connexions materials are in many languages, including English, Spanish, Chinese, Japanese, Italian, Vietnamese, French, Portuguese, and Thai. Connexions is part of an exciting new information distribution system that allows for **Print on Demand Books**. Connexions has partnered with innovative on-demand publisher QOOP to accelerate the delivery of printed course materials and textbooks into classrooms worldwide at lower prices than traditional academic publishers.