

S	R	Q	Q'
0	0	حفظ صفة قبل	
0	1	0	1
1	0	1	0
1	1	غير محدد	

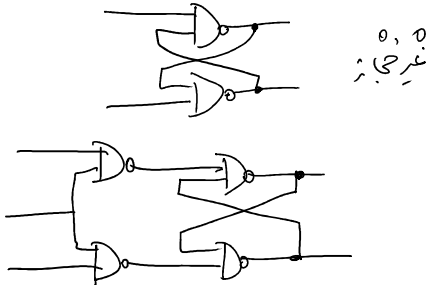

bounce

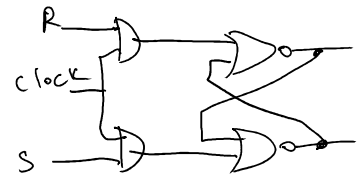
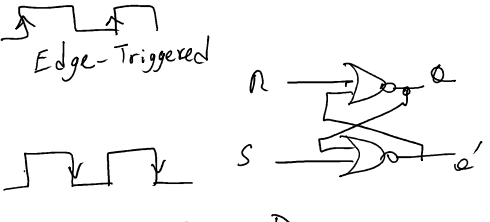
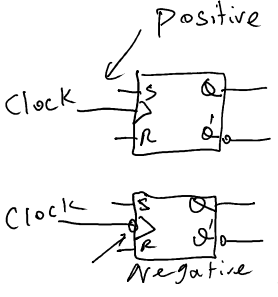
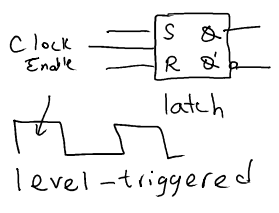
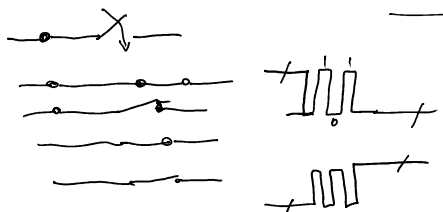

Debouncer

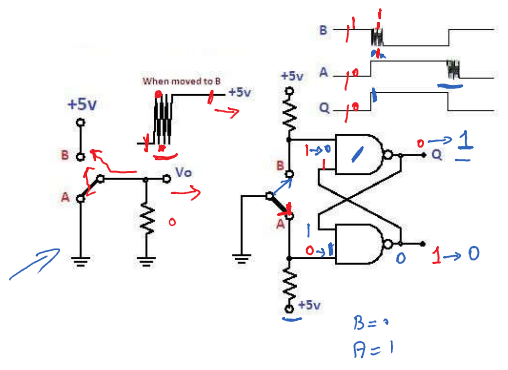
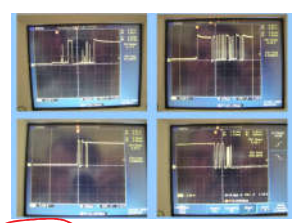

حفظ صفة قبل  
قبل

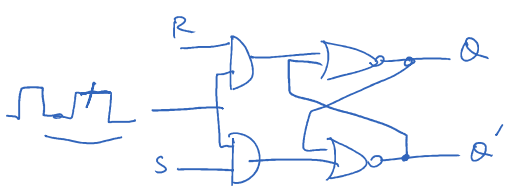
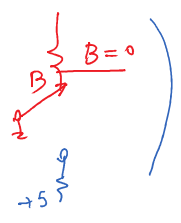
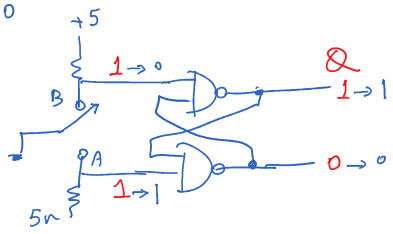

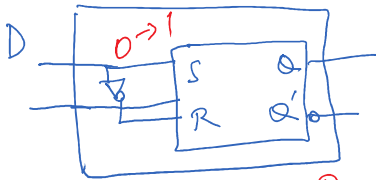

$D=0 \quad S=0 \quad R=1$   
 $D=1 \quad S=1, R=0$

D	Q	Q'
0	0	1
1	1	0

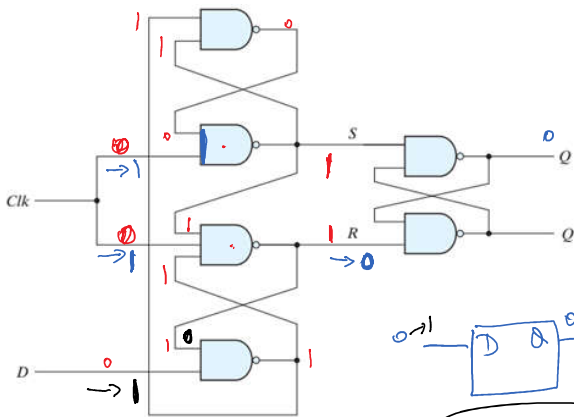
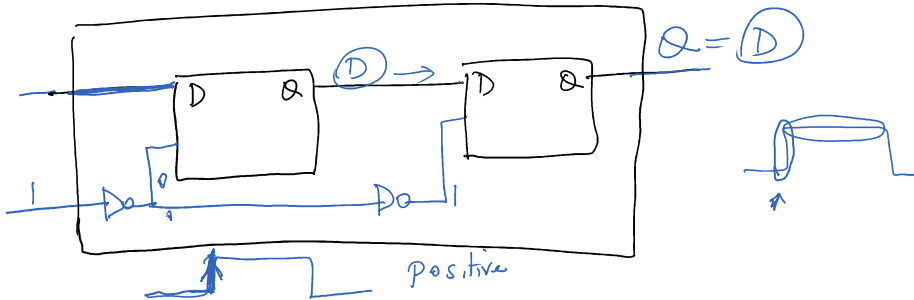
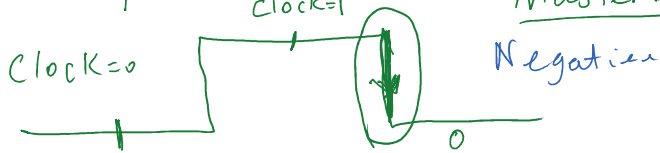
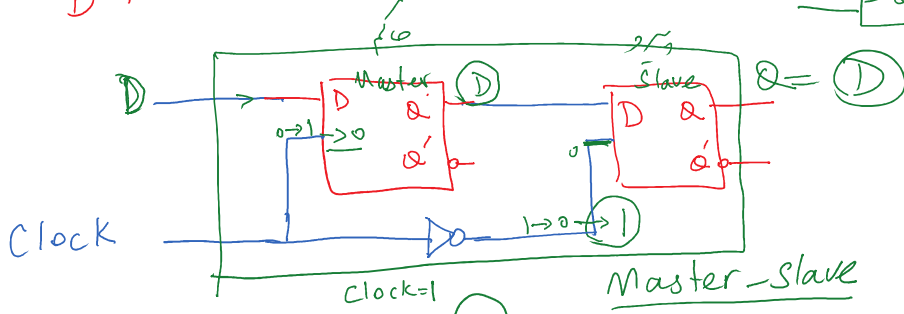

Clock = 0  
 $S=1, R=1$   
 $S=1, R=0$   
 $Q=0$   
 $D=1 \rightarrow S=1, R=0$

$D=0, \text{clock}=1$

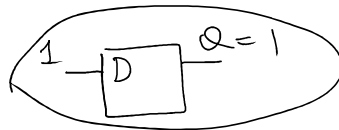

$D=1, \text{clock}=1$

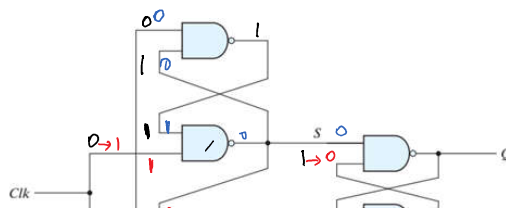

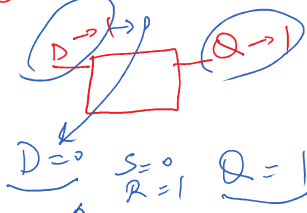
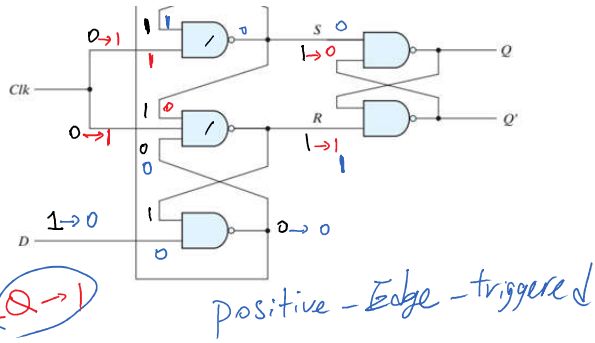
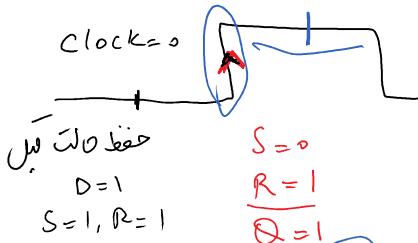

S	R	Q
0	0	حفظ حالت قبلی
0	1	0
1	0	1
1	1	X

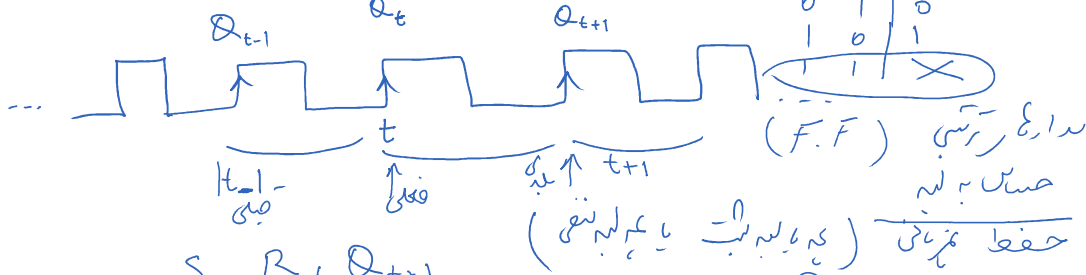

S	R	$Q_{t+1}$
0	0	$Q_t$
0	1	0
1	0	1
1	1	X

S	R	$Q_t$
0	0	$Q_{t-1}$



S	J	K	$Q_{t+1}$
0	0	0	$Q_t$
0	1	0	0
1	0	0	1
1	1	1	$Q_t'$

Characteristic Table

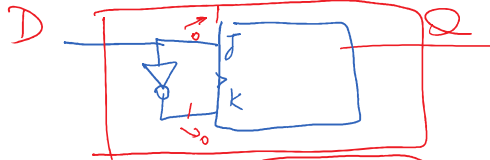

D	$Q_{t+1}$
0	0
1	1

$Q_{t+1} = D$

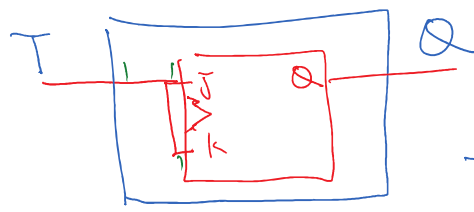
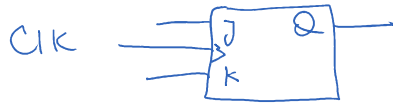

Toggle

T	$Q_{t+1}$
0	$Q_t$
1	$Q_t'$

